

# Electronics®

High-performance micropower amplifiers: page 48

Testing transistor leakage: page 53

Faster, better drawing by computer: page 64

June 1, 1964

75 cents

A McGraw-Hill Publication

Below: magnetic cores in logic circuitry, page 40

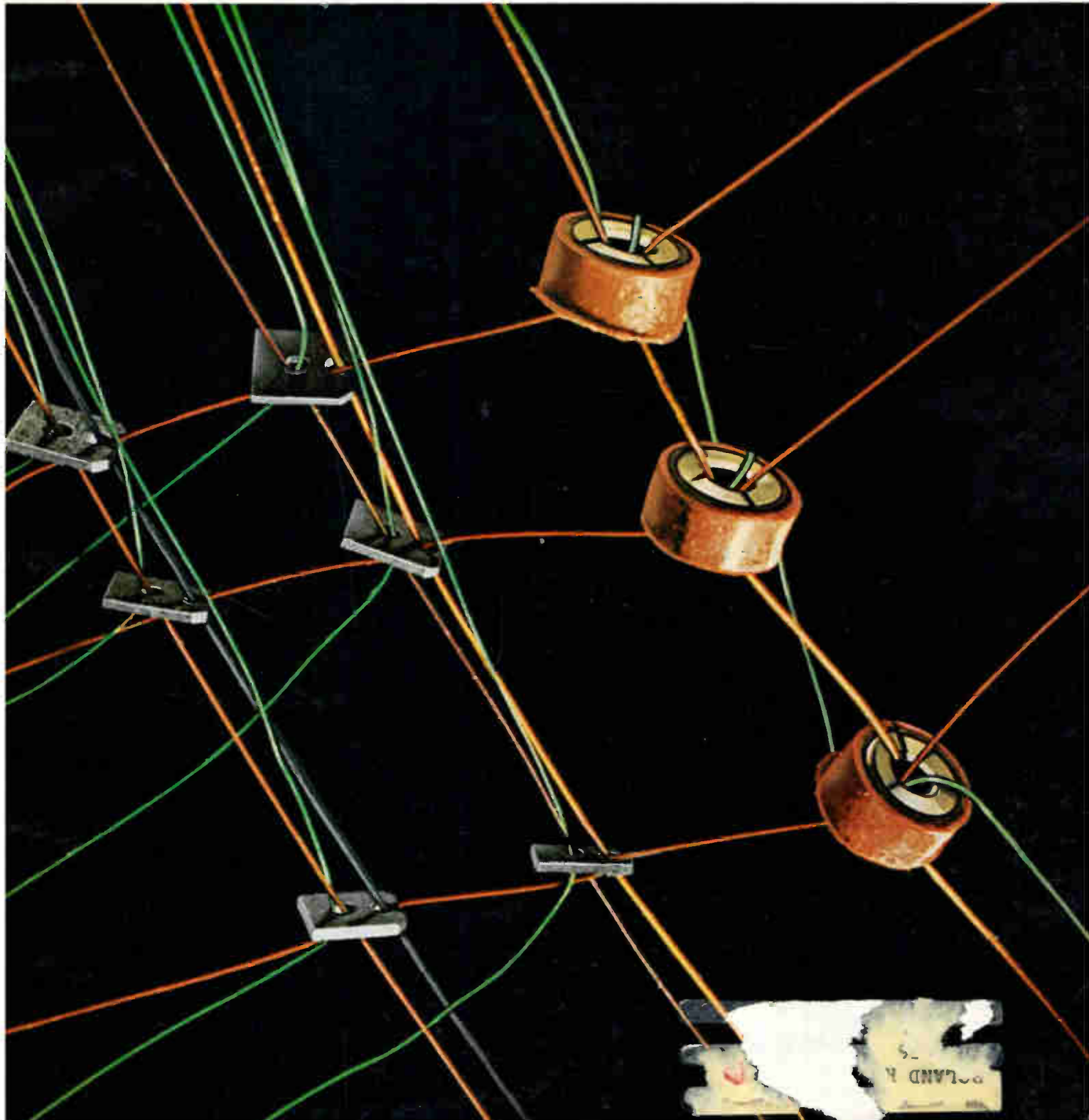



**HI-FI**  
Transistor output; matches any PP transistor to 4, 8, 16  $\Omega$  speaker. Primary 48, 36, 12  $\Omega$  C.T.; 20  $\Omega$  to 20 K $\Omega$ ; 40 watts.



**MINIATURE MIL TYPE**  
Metal case hermetically sealed to MIL-T-27B. Gold Dumet leads spaced on 0.1 radius, for printed circuit application.



**CHOPPER**  
Magnetic shielded plus electrostatic shield for voltage isolation of  $2 \times 10^4$ . Primary 200K C.T. to within 0.1%. Secondary 50K.



**HIGH POWERED AUDIO**  
Low distortion 2.5 KW output transformer, PP 450 TH's 18,500 ohms C.T. to 24/6 ohms, 20 KV hipot. 520 lbs.



**CATHODE FOLLOWER OUTPUT**  
Provides equal voltages to 5 loads. Primary inductance maintained to 5% with 20% change in DC unbalance and 30% change in AC voltages.

# SPECIAL (CUSTOM BUILT) AUDIO TRANSFORMERS TO YOUR SPECIFICATIONS



**HI-FREQUENCY CARRIER TO MIL-T-27B**  
Electrostatically shielded, humbucking, +30 dbm level. With in .5 db 250 cycles to 110 KC. 600/135: 600 centertapped to .1% tolerance.



**HYBRID TRANSFORMER**  
Two transformers each 600  $\Omega$  primary, 40K  $\Omega$  C.T. secondary 250 cycles to 5 KC within 1/4 db, 40 db isolation over band.



**MICROMODULE**  
Life tested per micromodule specs.: no failures. 10K  $\Omega$  C.T. to 10K  $\Omega$ , 100 mw from 400  $\Omega$  to 20K $\Omega$ .



**SUBMINIATURE MOLDED TRANSFORMER**  
Grade 3 with printed circuit leads for transistor application. 150  $\Omega$  to 150  $\Omega$  at 10 dbm level. Size 1/2 x 1/2 x 1/2"; weight 5 grams.



**BOLOMETER TRANSFORMER**  
Primary 10 ohms, secondary 530K ohms, 230:1 ratio, response from 1/2 cycle to 25 cycles. 120 db magnetic shielding, plus full electrostatic shielding.



**ULTRA-MINIATURE**  
Electrostatically & magnetically shielded output transformer 3/8 D. x 1/4" H. Pri. 15K CT, Sec. 8K CT; max. level 50 mw; audio range response. To MIL-T-27B, grade 4.

Exceptional quality and reliability is provided in all UTC designs. Over 30 years of engineering knowledge and experience substantiated by extensive field performance assure the highest quality and most reliable components in the industry. Complete environmental testing facilities are incorporated to prove out new designs. Full analysis and evaluation of materials are conducted in UTC's Material and Chemical Laboratories. Rigid quality control measures coordinated with exhaustive statistical findings and latest production procedures results in the industry's highest degree of reliability. Range covered in Audio Transformers is from 0.1 cycles to 400 MC . . . microwatts to 50 KW.

**MILITARY AND COMMERCIAL TYPES FOR EVERY PHASE OF THE ELECTRONICS ART**

**POWER TRANSFORMERS • AUDIO TRANSFORMERS • INDUCTORS • PULSE TRANSFORMERS • ELECTRIC WAVE FILTERS • LUMPED CONSTANT DELAY LINES • HIGH Q COILS • MAGNETIC AMPLIFIERS • SATURABLE REACTORS • REFERENCE UNITS**

Write for catalog of over 1,200 UTC HIGH RELIABILITY STOCK ITEMS IMMEDIATELY AVAILABLE from your local distributor.



**UNITED TRANSFORMER CORP.**  
150 VARICK STREET, NEW YORK 13, N. Y.

PACIFIC MFG. DIVISION: 3630 EASTHAM DRIVE, CULVER CITY, CALIF.  
EXPORT DIVISION: 13 EAST 40th STREET, NEW YORK 16, N. Y. CABLE: "ARLAB"  
Circle 900 on reader service card



## THIS CRYSTAL DETECTOR



MOUNTED INSIDE THIS  
DIRECTIONAL COUPLER



## INTRODUCES A DIRECTIONAL DETECTOR

Capable of Detecting Microwave  
Power ( $\pm 0.2$  db), 0.96 to 4.1 gc



### SPECIFICATIONS

Frequency Range:	786D, 796D, 0.96 to 2.11 gc 787D, 797D, 1.9 to 4.1 gc
*Frequency Response, 780 Series:	$\pm 0.2$ db
Sensitivity, 780 Series:	Low level, $4 \mu\text{V}/\mu\text{W}$ cw; high level, 35 mw produces at least 100 mv out
Directivity:	786D, 796D, 30 db 787D, 797D, 26 db
Main Line SWR:	786D, 796D, 1.10 787D, 797D, 1.15
Nominal Coupling Factor:	796D, 797D, 20 db
Maximum Input:	780 Series, 10 watts; 790 Series, 50 watts
Insertion Loss:	786D, 796D, approximately 0.25 db 787D, 797D, approximately 0.35 db
Price:	780 Series, \$275; 790 Series \$200

\*Because of the advanced design of the 780 Series these specifications relate the detected video power to the output power, rather than to the input power, as is customary in writing such specifications.

Data subject to change without notice. Prices f.o.b. factory.

**HEWLETT  
PACKARD  
COMPANY**



*An extra  
measure  
of quality*

1501 Page Mill Road, Palo Alto, Calif. 94304, (415) 326-7000.  
Sales and service in all principal areas. Europe, Hewlett-Packard  
S.A., 54 Route des Acacias, Geneva, Switzerland; Canada,  
Hewlett-Packard (Canada) Ltd., 8270 Mayrand St., Montreal, Que.

A new idea from Hewlett-Packard . . . unprecedented accuracy is yours with the new Hewlett-Packard Series 780 Directional Detectors. These new instruments enable you to obtain flat frequency response\* ( $\pm 0.2$  db), high directivity, high sensitivity, low swr and low insertion loss. High directivity results in sensitivity to forward power, not reflected power from mismatched loads. Directional detectors are ideal for closed-loop power leveling, since the instruments let you establish a level power point where you need it, not necessarily at the rf source.

Controlled specification ( $\pm 0.2$  db) is possible because a directional detector combines leveling variations found when using a separate coupler and detector.

The 780 Series instruments use a new Hewlett-Packard diode as a detector. It can be replaced easily without tools. The directional coupler (without the detector but with the same  $\pm 0.2$  db frequency response) is available in the Hewlett-Packard 790 Series. These instruments are moderately priced enabling you to easily improve the performance of your system.

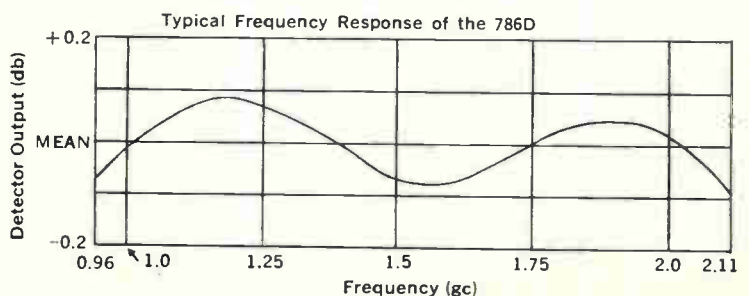

**NOW**  
*record microvolts  
 to hundreds of volts  
 with*

**←100MM RESOLUTION→**

SANBORN Recording Paper

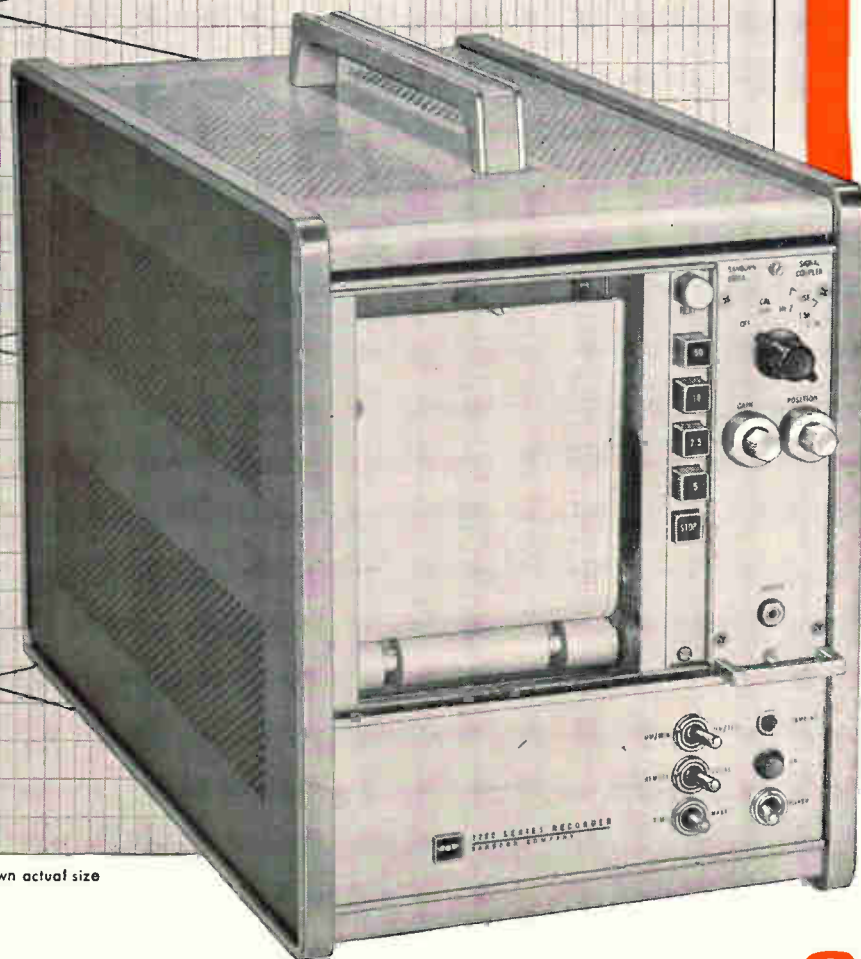

Record shown actual size

**SEE ANY  
 DC-30 CPS SIGNAL  
 FAR MORE CLEARLY  
 ON THE NEW SANBORN  
 INKLESS 100 MM  
 PORTABLE RECORDER  
 MODEL 7701A**

**Wide recording capabilities**

Interchangeable plug-in signal conditioners with calibrated zero suppression for low, medium, high gain DC and carrier applications.

**4 or 8 pushbutton chart speeds** from 0.5 mm/min to 50 mm/sec., with internal paper take-up

**Up to 2000 hours of continuous, unattended recording** without chart change

**Linearity  $\pm 1/2\%$  full scale ( $\pm 1/4$  div)**  
 . . . frequency response DC-30 cps, within 3 db, full scale

**Completely solid state circuitry for high reliability**, in accessible plug-in modules

**Prices start at \$1125 complete** (F.O.B. Waltham, Mass.; subject to change without notice)

**Compact and lightweight for bench or field use** . . . or mount two side by side in standard 19" rack for two-channel applications

Call your local H-P Field Engineering Office for complete specifications and application help . . . to put the right instrumentation to work on your measurement/signal conditioning/recording requirements. Or write Industrial Division, Sanborn Company, Waltham, Mass. 02154.

Circle 2 on reader service card

**SANBORN**  
 A DIVISION OF HEWLETT-PACKARD 



# Electronics

Editor: Lewis H. Young

Managing editor: John M. Carroll

## Senior editors

Technical: Samuel Weber  
News: George Sideris

Senior associate editors: Michael F. Wolff, John F. Mason

## Department editors

Advanced technology: George V. Novotny  
Circuit design: Jerome Eimbinder  
Communications: Alexander A. McKenzie  
Components: Michael F. Tomaino  
Computers: Stephen B. Gray  
Consumer electronics: V.S. Acunto  
Industrial electronics: Louis S. Gomolak  
Instrumentation: George J. Flynn  
Manufacturing: C.R. Whetstone  
Military electronics: John F. Mason  
New products: William P. O'Brien  
Solid state: Michael F. Wolff, G.G. Tirellis  
Space electronics: Joel A. Strasser  
Staff writers: Leon H. Dulberger, Peggy Jackson

## Regional editors

Boston: Thomas Maguire, editor; Alice M. Moyer  
Chicago: Cletus M. Wiley, editor; Virginia T. Bastian  
Los Angeles: Harold C. Hood, editor; Linda Hamner  
San Francisco: Laurence D. Shergalis, editor; Mary Jo Jadin  
London: Derek Barlow, editor

## Copy editors

Howard Rausch, Sally Powell

## Illustration

Art director: Howard R. Berry  
Assistant art director: John C. Wright, Jr.  
Editorial production: Ann Mella, Sandra A. LeMond

Editorial secretaries: Claire Benell, Lynn Emery,  
Kay Fontana, Lorraine Rossi, Lorraine Werner

## McGraw-Hill news service

Director: John Wilhelm; Atlanta: Fran Ridgeway; Chicago: Bruce Cross;  
Cleveland: Arthur Zimmerman; Dallas: Marvin Reid;  
Detroit: Donald MacDonald; Los Angeles: Kemp Anderson, Michael Murphy,  
Ron Lovell; San Francisco: Margaret Ralston, Ed. Addeo;  
Seattle: Ray Bloemberg; Washington: George Bryant Jr., Glen Bayless,  
Charles Gardner

## McGraw-Hill world news service

Bonn: Richard Mikton; Brussels: Arthur Erikson; London: John Shinn;  
Mexico City: Wesley Perry; Milan: Bruce Bendow;  
Moscow: Donald Winston; Paris: Dan Smith;  
Rio de Janeiro: Leslie Warren; Tokyo: Richard Halloran, Charles Cohen

Circulation manager: Hugh Quinn

Reprints: T.M. Egan

Publisher: C.C. Randolph

Electronics: June 1, 1964, Vol. 37, No. 17

Printed at 99 North Broadway, Albany, N.Y.  
Second class postage paid at Albany, N.Y.

Subscriptions are solicited only from those actively engaged in the field of the publication. Position and company connection must be indicated on orders. Subscription prices: United States and Possessions and Canada, \$6.00 one year, \$9.00 two years, \$12.00 three years. All other countries \$20.00 one year. Single copies, United States and Possessions and Canada 75¢, Single copies all other countries \$1.50.

Published every other Monday by McGraw-Hill Inc. 330 West 42nd Street, New York, N.Y. 10036. Founder: James H. McGraw, 1860-1948.

Subscribers: The Publisher, upon written request to our New York office from any subscriber, agrees to refund that part of the subscription price applying to copies not yet mailed. Please send change of address notices, subscription orders or complaints to Fulfillment Manager, Electronics, at the address below. Change of address notices should provide old as well as new address, including postal zone number if any. If possible, attach address label from recent issue. Allow one month for change to become effective.

Postmaster: Please send Form 3579 to Fulfillment Manager, Electronics, P.O. Box 430, Hightstown, New Jersey 08520

## Readers Comment

### Eye-opener

Thank you for your article [May 18, p. 105] on the employment outlook for engineers. It is about time someone told the truth about a situation which has been steadily worsening.

Your article was the first I've seen contradicting the phony, trumped-up demand for engineers that other publications and news media have been stressing. I only hope that your article will open the eyes of any individuals planning on entering the engineering profession.

Paul Lenoble

Senior Electronics Engineer  
Republic Aviation Corp.  
Farmingdale, L.I., N.Y.

### No Mecca in Dallas

As the wife of an electronics engineer who has been out of work for over seven months, I was most pleased to see that your publication was finally taking cognizance of the fact that all was not well with military electronics [May 18, p. 105].

However, I was very upset to see the Dallas-Ft. Worth area described as a Mecca. This may have been the case last summer but is far from true now. Bell and General Dynamics have some demand for aeronautical and mechanical engineers, but no electronics at the present time. The head of Collins personnel admitted that "engineering has had it at Collins" in private conversation here. Texas Instruments needs juniors in semiconductor work but has many qualms about seniors. LTV has had a 60% across-the-board cut; some are out with long tenures.

The rest of the stuff in the area is very small; there are only one or two five-figure salaries in some companies. Texas pays the lowest unemployment insurance of any state (\$36 a week) and it is hard to qualify for. If a jobless engineer wants to put his wife to work, he can expect her to make just about the legal minimum, degree or no degree; there is a large pool of labor here.

## Capacitance Standards to Certified Accuracy of $\pm 0.1\%$ Developed by Sprague

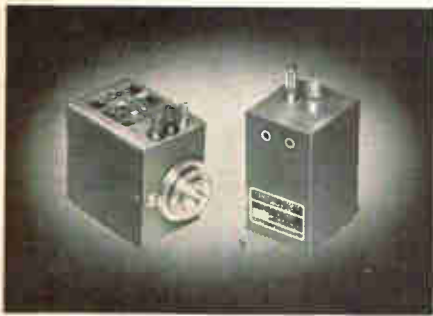

A broad range of capacitance values from  $.001 \mu\text{F}$  to  $100 \mu\text{F}$ , furnished to an accuracy of  $\pm 0.1\%$  of the nominal values, are available in Styracon Precision Capacitors, components for highly precise electronic equipment as well as for laboratory standards of capacitance.

These high-accuracy capacitors, designed and developed by the Sprague Electric Company, offer the maximum capacitance stability possible in the state of the art. The measurements of Styracon Precision Capacitors are correlated with similar capacitors certified in the laboratories of the National Bureau of Standards.

**Specially Processed Film Dielectric**  
Hermetically-sealed Styracon Capacitors employ a specially processed polystyrene film as their dielectric, resulting in capacitors with extremely high insulation resistance, negligible dielectric absorption, and low dissipation factor (high  $Q$ ).

Styracon Precision Capacitors are useful in a very broad range of applications from d-c timing and integrating circuits to filters and tuned circuit design.

### Styracon Decade Capacitors

The Sprague Styracon family also includes a line of Triple Decade Capacitors with direct in-line read-out, offering a convenient means of quickly adjusting capacitance in both the laboratory and in precision electronic equipment in the field.

Accurate to  $\pm 0.5\%$  of the nominal capacitance for any dial setting, Sprague Decade Capacitors are available in two basic ranges of capacitance— $0.0001$  to  $0.1099 \mu\text{F}$  and  $0.001$  to  $1.099 \mu\text{F}$ —in either bench or panel mounting styles.

For complete technical data, write for Engineering Bulletins 90.600 and 90.605 to Technical Literature Service, Sprague Electric Co., 35 Marshall St., North Adams, Mass.

Circle 5 on reader service card

# Did you know Sprague makes...?

## MAGNETIC LOGIC DEVICES



Core-diode and core transistor magnetic shift registers and magnetic counters for switching and storage applications in computer and logic circuitry.

CIRCLE 277 ON READER SERVICE CARD

## MOLDED PULSE TRANSFORMERS

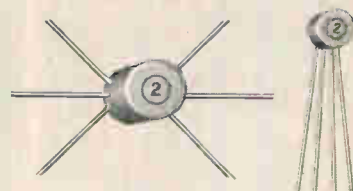

Miniature Pulse Transformers with tough molded cases for increased protection against physical damage and severe atmospheric conditions.

CIRCLE 278 ON READER SERVICE CARD

## NANOSECOND PULSE TRANSFORMERS IN TO-5 TRANSISTOR CASES



Special design offers distinct advantages: (1) Mini-fied size. (2) Welded hermetic seal. (3) Increased reliability. (4) Compatibility with transistor mounting techniques.

CIRCLE 279 ON READER SERVICE CARD

## SOMETHING NEW IN COUNTING TECHNIQUES



Simple yet versatile, low-cost yet reliable counters available for predetermined (2 to 11) or selectable (5 through 10) counting cycles.

CIRCLE 280 ON READER SERVICE CARD

## DYNACOR® BOBBIN CORES



Series "300" Cores with logical flux values in popular physical sizes are stocked in production quantities for fast delivery. They're value engineered for quality with economy!

CIRCLE 282 ON READER SERVICE CARD

## HERMETICALLY-SEALED TO-5 ENCASED SWITCH CORES



Designed especially for high-speed, low-power switching up to 100 kc, adaptability with conventional transistor packaging techniques, and performance under MIL-S-21038 environmental conditions.

CIRCLE 281 ON READER SERVICE CARD

## ELECTRONIC MODULES TO CUSTOMER REQUIREMENTS



Custom packaging is no novelty at Sprague's Special Products Division, where "specials" are continually being developed and produced with countless variations in electrical characteristics and mechanical configurations.

CIRCLE 283 ON READER SERVICE CARD

For application engineering assistance (without obligation, of course) on any of the above products, write or call the Special Products Division, Sprague Electric Company, 35 Union Street, North Adams, Massachusetts.

455P-111-63 R4

**SPRAGUE®**  
THE MARK OF RELIABILITY

\*Sprague\* and \*®\* are registered trademarks of the Sprague Electric Co.

## Obviously from Sprague!



### ... the precision/power wirewound resistor with more **PLUS** features!

**Silicone Encapsulated**—Seals resistance element. Provides exceptional protection against severe environmental conditions as well as physical damage.

**Wide Application**—Standard and non-inductive windings. Equally suited for printed wiring boards, custom packaging, and point-to-point wiring.

**Close Resistance Tolerances**—Standard tolerances to  $\pm 0.05\%$ .

**Wide Range of Ratings**— $\frac{1}{4}$  watt to 10 watts. Resistance values from  $.05\Omega$  to  $66K\Omega$ .

**Minified Sizes**—Smaller than other conventional wirewound resistors.

**Excellent Stability**—Under extended load life and environmental operating parameters, Acrasil Resistors show exceptionally small change in resistance values.

**Outstanding Reliability**—Fully meet electrical performance requirements of MIL-R-26C, as well as individual customer high reliability specifications.

*For complete technical data, write for Engineering Bulletin 7450 to Technical Literature Service, Sprague Electric Company, 35 Marshall St., North Adams, Mass.*



\*Sprague\* and \*®\* are registered trademarks of the Sprague Electric Co.  
45 PR-100-03

So please gentlemen, don't send your innocent readers off to the Mecca here in Dallas.

One other thing, there is a good deal of bleating about the usefulness of veterans, and the below-average engineer. The man who is in "trouble" is a thoroughly competent professional with a degree in physics who has worked in just about every phase of applied research—from writing proposals to filling black boxes and checking out hardware. He has worked in highly classified areas where even the department head didn't know what he was doing, so when development contracts become scarce, they lop him off rather than charge him to overhead like valuable "personnel" experts and sales engineers.

When he answers ads for other jobs he can't tell what he has been doing and is told "that's your tough luck." He missed the boat on getting into company politics deeply enough to become "valuable." And of course he is not nearly as valuable as recent graduate "paper engineers." Many companies spend money recruiting young talent from colleges and universities with about the same altruism that the A&P and Safeway supermarkets buy prime yearlings at the Fat Stock Show in Fort Worth; it's just good publicity.

I have literally lived with the electronics mess long enough to know that the men who are out are as good or better than 90% of those who are working.

Mailer of a Thousand Resumes  
Richardson, Texas

#### Picturephone rates

In your otherwise excellent article on the Bell System's picturephone service [May 4, p. 29], you created. I fear, a false impression of the rates being charged for picturephone calls. Your third paragraph stated, in effect, that charges for the service would be more than 100 times the rates for normal long distance calls between the cities involved in the picturephone network. Even after 9 p.m., this would put a three-minute picture call between Chicago and New York at \$90. This is not the case. Here are the picturephone rates for the first three minutes of calling: between Washington, D. C. and New York,

\$16; between Chicago and Washington, D. C., \$21; between Chicago and New York, \$27.

D.H. Van Lenten  
American Telephone and  
Telegraph Co.  
New York

#### Packaging

In your article on Modern Electronics Packaging [Feb. 7, p. 39], there is a picture of a multiband low-frequency receiver which is actually the AN/WRR-3 shipboard receiver. The picture caption refers to "... this Capehart Corp. design. ..."

We wish to call to your attention that the design for this equipment was performed by the Magnavox Co. under a navy prime contract number NObsr 81131.

James H. Anderson  
Magnavox Co.  
Fort Wayne, Ind.

The equipment photographed on page 39 is the Capehart model of the AN/WRR-3. It is true this device was developed initially by Magnavox and that they have a competitive contract to build the same equipment currently. While it is true that we still have additional work to do before our model goes into production, the unit lent to Electronics for the photograph was built with Capehart parts even though, at the time, there were many engineering problems to overcome before the unit would be suitable for delivery under the terms of the government specification.

Joseph H. Vogelman  
Vice President  
Capehart Corp.  
Richmond Hill, N.Y.

#### Complementary amplifier

In your May 18 issue, the complementary amplifier circuit [p. 92] has a resistor,  $R_4$ , which is completely shorted.

We would appreciate a correction, as we want to construct such an amplifier.

F.W. Corbett  
F.W. Corbett Science Labs.  
Los Angeles

the right of capacitor  $C_1$ .

▪ Remove the junction dot just to



# For lab or field, there is an NF-105 for every RFI measurement



- Electromagnetic compatibility
- Field intensity
- Antenna analysis
- Noise studies
- Shielding effectiveness
- Spurious radiation
- Harmonic measurements

**PERMANENT INSTALLATIONS**—Newest in the NF-105 family of Noise and Field Intensity Meters, the Model NF-105F, serves permanent installations or those that cannot tolerate even the short delay of unit replacement in the regular NF-105. Rack mounted in fixed locations, in vans or in airplanes, it supplements rather than supersedes the regular NF-105 for quick scanning of the entire frequency range from 14 kc to 1 gc.

**ULTRA-SENSITIVITY**—Model NF-105/M-126 is the ultra-sensitive instrument. Available in both portable and fixed-location designs, it has sensitivities of minus 126 to minus 130 dbm for narrow band measurements.

**PORTABLE VERSATILITY**—Most popular instrument of them all, the NF-105 covers the range from 14 kc to 1 gc by means of five quick-change tuning units and one basic measuring unit (no expensive redundancies). It has X-Y output for recording and IF output for panoramic viewing.

**SPECIAL APPLICATIONS**—In some instances, Model NF-205 may be preferred. Similar to Model NF-105, it utilizes a single repetition rate mercury type impulse generator.

The entire range 20 cps to 21 gc is now covered with just three instruments—the NF-315 (20 cps-15 kc), NF-105 (14 kc-1 gc), and NF-112 (1-21 gc)—instead of the six or more required with other, less versatile makes.

**For complete information**, contact the address below or your nearest Empire representative, requesting Catalog No. 634 and a demonstration.

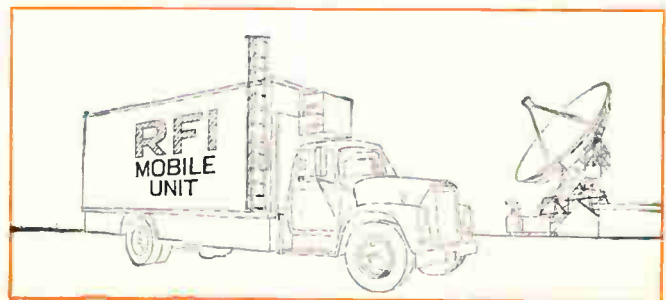

**THE SINGER COMPANY  
METRICS DIVISION**

915 PEMBROKE STREET  
BRIDGEPORT, CONNECTICUT

ELECTRICAL AND ELECTRONIC INSTRUMENTS FOR TEST, CALIBRATION, AND MEASUREMENT

Circle 7 on reader service card

E-642

# People

**CONSIDERING VAPOR COOLING?  
SELECT ONE OF MACHLETT'S  
4 BASIC SYSTEMS...**

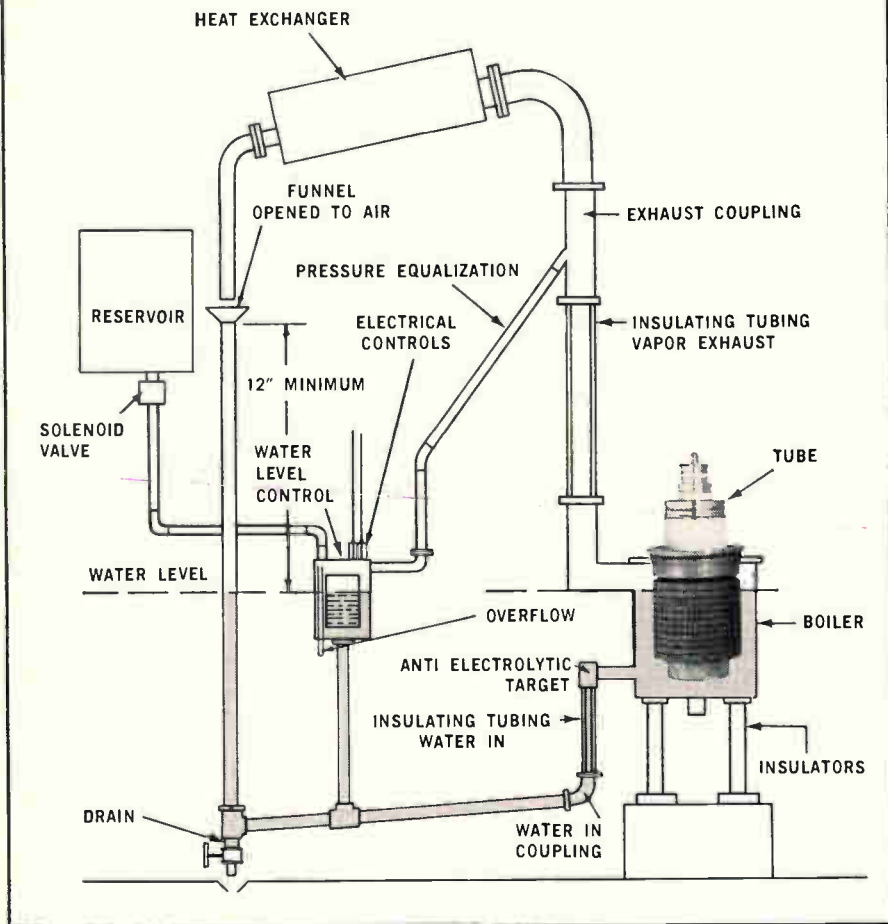

**From 50kW to 500kW, Machlett offers four basic Vapor Cooling Systems for cooling high power electron tubes:**

SYSTEM	TYPICAL APPLICATION
Vapor-Up (shown above).....	General Broadcast (HF)
Vapor-Down.....	General & SSB Communications (HF)
Boiler Condenser.....	Industrial
Integrated.....	Special Service. Particularly suited to VHF.

System advantages include: 200-300% greater anode dissipation as compared to forced-air cooling; 10-20% greater anode dissipation over conventional water cooling; extremely large overload protection for anode; stable, quiet cooling; low water consumption; low operating costs.

Each of the above four systems is highly adaptable to a wide range of applications. Consider the advantages of each system—outlined in "Vapor Cooling," obtained by writing to The Machlett Laboratories, Inc., Springdale, Conn., an affiliate of Raytheon Company.



**Uryon S. Davidsohn**, 40-year-old director of the physical electronics division of Radiation, Inc., Melbourne, Fla., is understandably proud of the company's brand new million-dollar microcircuits facility. He designed and laid out the plant, hand-picked the personnel, and heads the group that he intends to make a strong force in the microelectronics business.



Making a new start is not unusual for Davidsohn. He left his job with Western Electric Corp., spent nine months in California on an agricultural training farm and, in 1949, took his wife to Israel. There they spent two years as "kibbutzniks" in an Israeli cooperative, helping to build a concrete village for refugees from displaced persons camps. Their first daughter, Yael, now 13½, was born in Israel.

Returning to the United States in 1952, Davidsohn joined General Electric Corp.'s semiconductor products department in Syracuse, N. Y., where he worked in measurements and characterization of semiconductor device parameters. When General Electric wanted to get into integrated circuits, Davidsohn devised the matrix approach and put the company into a competitive position in nine months. He and his wife spent eight years building a 3,500-sq-ft ranch house in Syracuse. They also had three more children and accumulated seven horses.

Radiation, Inc., primarily a systems-oriented organization, decided that Davidsohn was the man to direct its move into microcircuits and induced him to leave Syracuse and all but two of the horses.

The microcircuit project is a gamble but Radiation feels it must take it to compete in the future aerospace industry. As Davidsohn says:

"This company's got guts. It's willing to try things, even though it's bucking some of the big boys."

COMPLETE SYSTEMS CAPABILITY FROM ANTENNA TO COMPUTER

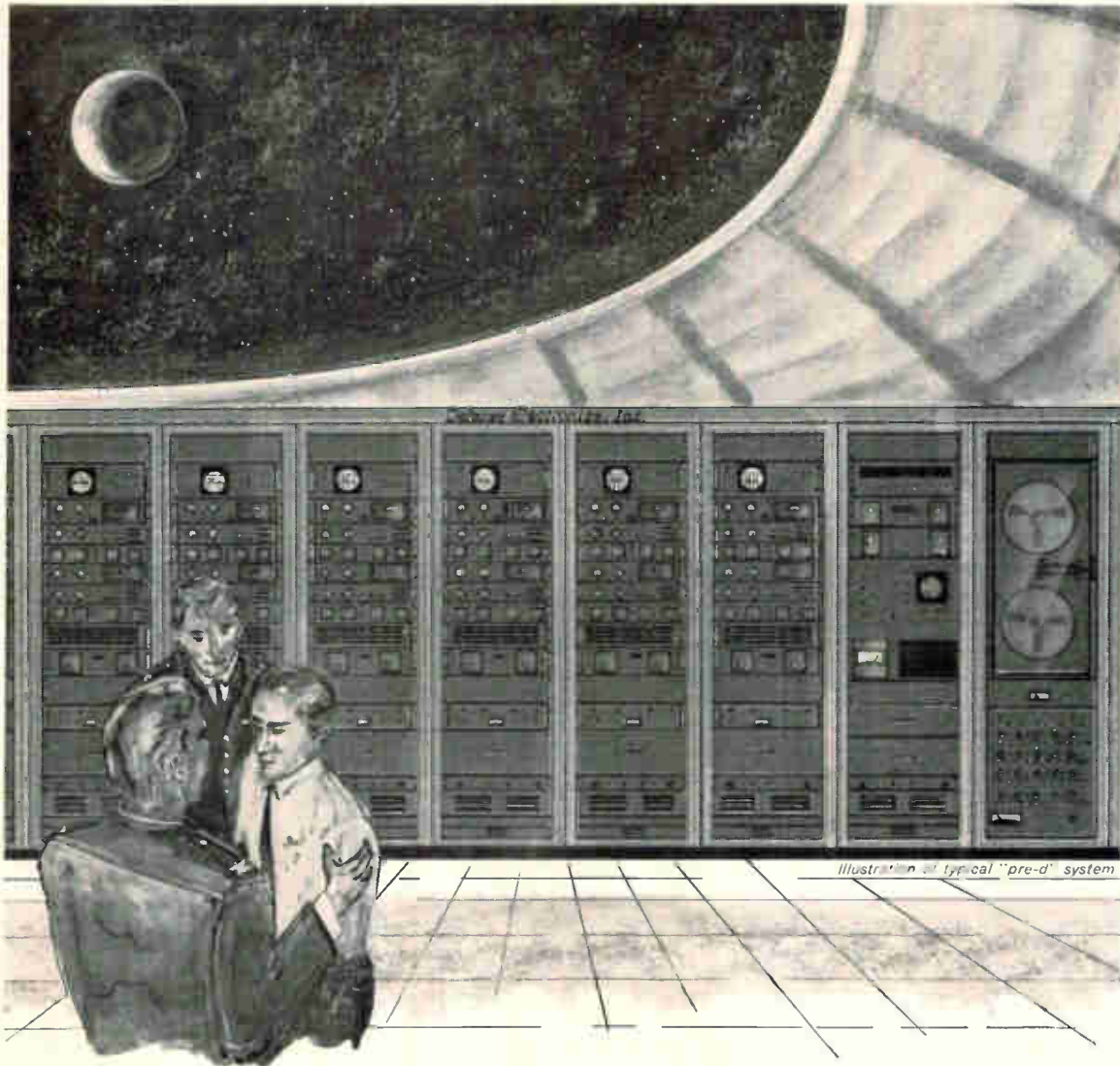

## PREDETECTION TELEMETRY SYSTEMS...

A MAJOR PROCESSING ADVANCE FOR SPACE DATA

The most advanced telemetry systems in the future, both here and abroad, will employ the predetection concept of processing space data . . . a communications technique for which Defense Electronics, Inc. is the acknowledged industry leader.

"Pre-d" recording preserves the original space data before it is detected and demodulated. In contrast to real time recording, predetection processing permits repeated use of the data for different scientific applications.

In the next several years, both the U.S. Air Force and the National Aeronautics and Space Administration will install "pre-d" telemetry receiving and recording systems designed and built by DEI . . . to insure optimum use of data generated by future manned or unmanned space vehicles.

The DEI systems will provide proven reliability, flexibility and economy.

During 1964, Defense Electronics, Inc. will continue to improve its predetection systems as well as digital and RF equipments to assure the continued reputation it presently enjoys as one of the leaders in telemetry and space communications.

A highlight of the year will be the proposed consolidation of activities of our five plants in the Washington, D.C. suburbs through construction of a new 85,000 square foot building.

In every phase of our activity, there is growth . . . substantial growth . . . and this, in turn, means exceptional career opportunities for qualified electronic engineers, particularly in our expanding Systems Division and PCM equipment design section.

Write for FREE Corporate Brochure.

See us at  
NATIONAL  
TELEMETRY  
CONFERENCE



**DEI**  
RESEARCH  
DEVELOPMENT  
MANUFACTURING

*Defense Electronics, Inc.*

ROCKVILLE, MARYLAND

PHONE (301) 946-2600 TWX 301-949-6788

SHERMAN OAKS, CALIFORNIA PHONE (213) 873-4322

## New from Sprague!

# A BETTER, LESS-EXPENSIVE WAY TO TRIGGER SCRs!

TYPE 35Z

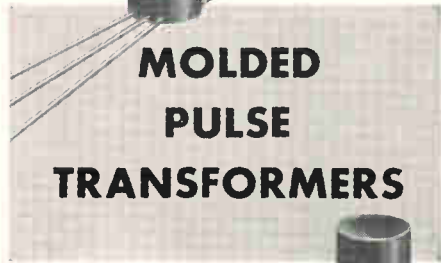

## MOLDED PULSE TRANSFORMERS

TYPE 48Z



- Optimized characteristics for SCR gate triggering and isolation.
- Approved for line applications to 550 volts.
- Will accommodate large SCR gate impedance differences.
- Low coupling capacitance attenuates line transients avoiding false triggering.

Now, you can choose from 3-winding and 2-winding pulse transformers for full-wave and half-wave SCR trigger applications. Select from 2 designs, one suitable for use with line voltages up to 220 volts, the other up to 550V R-M-S, in both radial lead (Type 35Z) and pin (Type 48Z) styles.

With Sprague Pulse Transformers, you can actually cut costs without sacrificing dependability — the tough, fully molded transformers meet the rough environmental demands of military and industrial equipment, yet cost no more than cast or dipped housings found in commercial applications.

For complete technical data, write for Engineering Bulletin 40,225.2 to the Technical Literature Service, Sprague Electric Co., 35 Marshall St., North Adams, Massachusetts.

45SP-4108

**SPRAGUE**<sup>®</sup>  
THE MARK OF RELIABILITY

<sup>®</sup>Sprague and <sup>®</sup> are registered trademarks of the Sprague Electric Co.

## Meetings

Electromagnetic Windows Symposium, The Antenna Lab., Dept. of Electrical Engineering, Ohio State Univ. in conjunction with US Air Force; Ohio State Univ., Columbus, Ohio, June 2-4.

Telemetry National Conference AIAA; Biltmore Hotel, Los Angeles, Cal., June 2-4.

Electromagnetic Compatibility National Symposium, PTG on Electromagnetic Compatibility, IEEE, Inc.; International Hotel, Los Angeles, Calif., June 9-11.

Basic Failure Mechanisms and Reliability in Electronics Conference, IEEE; Newark College of Engineering, Weston Hall, Newark, N.J., June 15.

Conference on Precision Electromagnetic Measurements, NBS, Radio Stds. Lab., IEEE PTG-IM, Inter. Scientific Radio Union, US Commission on Radio Measurements and Standards; NBS Boulder Laboratories, Boulder, Colo., June 23-25.

Computers and Data Processing Annual Symposium, University of Denver's Research Institute; Elkhorn Lodge, Estes Park, Colo., June 24-25.

Joint Automatic Control Conference, ASME, AICE, ISA, IEEE, AIAA; Stanford University, Stanford, Cal., June 24-26.

Conference of Vacuum Metallurgy, Vacuum Metallurgy Div., American Vacuum Society; Barbazon Plaza Hotel, New York City, June 29-30.

Aerospace Reliability and Maintainability Annual Conference, SAE, ASME, AIAA; Statler Hilton Hotel, Washington, D.C., June 29-July 1.

Rochester Conference on Data Acquisition and Processing in Medicine and Biology, U. of Rochester; U of R Whipple Auditorium, Rochester, N.Y., July 13-15.

Special Technical Conference on Nuclear Radiation Effects, IEEE PTG-NS, Radiation Effects Committee; University of Washington, Seattle, Wash., July 20-24.

Special Program on Language Data Processing, Harvard, Div. of Engineering and Applied Physics; Harvard Summer School, Cambridge, Mass., Aug. 10-21.

UAIDE Annual Meetings, Users of Information Display Equipment; International Hotel, Sepulveda and Century Blvds, Los Angeles, Cal., Aug. 12-14.

Symposium on Ultra Low Frequency Electromagnetic Fields, NBS Central Radio Propagation Lab. and National Center of Atmospheric Research; Boulder Laboratories, Boulder, Colo., Aug. 17-20.

WESCON 1964, 6 Region IEEE and Western Electronic Manufacturers Asso.; Los Angeles Sports Arena and Hollywood Park, Los Angeles, Cal., Aug. 25-28.

International Conference on Microwaves, Circuit Theory and Information Theory, Inst. Electrical Comm. Engrs. of Japan, Science Council of Japan and International Scientific Radio Union; Alaska Prince Hotel, Tokyo, Sept. 7-11.

International Convention on Military Electronics (MIL-E-CON 8), IEEE; Shoreham Hotel, Washington, D. C., Sept. 14-16.

Ceramic-To-Metal Session, American Ceramic Society; Philadelphia, Sept. 17.

Engineering Management Annual Conference, IEEE-ASME; Pick-Carter Hotel, Cleveland, Ohio, Sept. 17-18.

AIAA Military Aircraft Systems and Technology Meeting (Secret), AIAA, USAF, and BuWeeps; NASA-Langley Research Center, Va., Sept. 21-23.

## Call for papers

Nuclear Science Symposium, PTG on Nuclear Science—IEEE, National Aeronautics and Space Administration, U.S. Atomic Energy Commission; Philadelphia, October 28-30. Deadline is July 1 for submitting abstracts to W.A. Higinbotham, Brookhaven National Laboratory, Upton, Long Island, N.Y. 11973.

Professional Technical Group on Vehicular Communications Annual Conference, IEEE; Sheraton Hotel, Cleveland. December 3-4. August 1 is deadline for submitting a 50 to 100 word abstract to N.C. Colby, RCA Telecommunications Center, Meadow Lands, Pennsylvania. Topics invited are vehicular systems planning, RFI and intermodulation, propagation, equipment design, measurements, reliability, and economics in systems design.



**±0.01%**  
VOLTAGE  
calibration  
accuracy



## ONE INSTRUMENT **382A** OFFERS DUAL MODES



**±0.02%**  
CURRENT  
calibration  
accuracy



### NEW FLUKE VOLTAGE/CURRENT CALIBRATOR

New solid state Fluke Model 382A is a combination  $\pm 0.01\%$  voltage calibrator with 0-50V capability in two ranges, and  $\pm 0.02\%$  current calibrator with 0-2 ampere capability in four ranges.

Line or load regulation is 5 ppm. Main feedback loop amplifier is chopper-stabilized. Fluke-manufactured, precision wirewound resistors in the sample string are matched for accuracy and temperature coefficient. Reference zener diode and current regulating components are isolated in temperature-controlled oven.

Current and current/voltage limiting provide precise and continuously variable control of output. Continuous short-circuit is harmless to the instrument. Removal of overload restores normal operation. Current or voltage limiting is indicated by front panel lamp.

Output is controlled via six in-line front panel decade switches. Terminals are provided both front and rear for remote sensing of output voltage. Mechanical construction utilizes plug-in flow-soldered glass-epoxy printed circuit boards.

Model 382A requires only  $5\frac{1}{4}$ " of rack space. Price is \$1,595. The Model 383B, a digitally programmed version of the Model 382A, is available for systems applications. Be among the first to get the full story!

Send for full specification data on the Model 382A, plus new 64A Catalog Digest describing 40 models of Fluke differential voltmeters, power supplies and other precision instruments. Address JOHN FLUKE MFG. CO., INC., Box 7428, Seattle, Wash. 98133.



Precise performance in the  
**VOLTAGE MODE**  
for calibration of voltmeters and  
instrumentation systems

OUTPUT VOLTAGE: 0 to 50 VDC;  
0 to 5 VDC  
OUTPUT CURRENT: 0-2 amperes, limited  
to any preset value from 2 ma to 2 amps  
in three ranges  
CALIBRATION ACCURACY:  $\pm 0.01\%$   
STABILITY: Per hour, 0.002%; per day,  
0.0025%; per month, 0.005%  
RIPPLE: Less than 50  $\mu$ V RMS  
RESOLUTION: 100  $\mu$ V (50V range); 10  $\mu$ V  
(5V range)



Precise performance in the  
**CURRENT MODE**  
for calibration of ammeters, current  
shunts, resistors; gyro torquing and  
solenoid excitation

OUTPUT CURRENT: 0-2 amps in four rgs.;  
0-5 ma, 0-50 ma, 0-500 ma, 0-2 amps  
OUTPUT VOLTAGE: Limited to any preset  
value from 5 to 55 volts in one continu-  
ously variable range  
CALIBRATION ACCURACY:  $\pm 0.02\%$   
STABILITY: Per hour, 0.0025%; per month,  
0.005%  
RIPPLE:  $\pm 0.002\%$  of range RMS  
RESOLUTION: 0.01  $\mu$ A maximum





# create the unknown

## in communications and data processing systems

You see illustrated the National Security Agency (circa 1965 when fully built), about whose activities little is known, and not much more can be told. This much we can say—the Security Agency produces secure communications systems and equipments unknown anywhere else . . . devises unique refinements for computers and edp systems . . . and offers a wealth of possibilities for intellectually curious engineers.

This involves design of new antennas, transmitters, receivers, and terminal equipment—and the invention of advanced solid-state & electronic devices. Follow-on work leads to the construction of breadboard and basic engineering models using new semiconductors, magnetic film, superconductive devices, and other promising developments. Knowledge derived from this sort of study and experimentation may result in the design of new logic circuits and memory units for data-processing systems . . . better high-gain arrays for UHF radio systems . . . higher-capacity data handling terminal equipment . . . advanced oscillographic recording techniques . . . more effective speech band-width compression . . . and scores of similar progressions in secure communications.

In many ways, the National Security Agency is a totally unique organization. It works closely with many industrial activities and research institutions; it has special access to scientific information at universities and other Government laboratories; and it enjoys close consulting arrangements with scientists of commanding stature. These advantages—together with its own well-instrumented laboratories and large complement of specialists in amazingly varied fields—provide an intellectually stimulating environment for individual accomplishment.

Perhaps the exceptional appeal of NSA can best be shown by a few random facts and observations:

- Although a DOD activity, it has influence and responsibility of far greater scope.
- While avoiding the Government cluster of downtown Washington, it is still handy

to the Capital area, Baltimore, Friendship Airport, Maryland University . . . and the Chesapeake Bay region.

- Staff associates include a stimulating sprinkling of nontechnical professionals, ranging anywhere from musicology to linguistics and philosophy.
- It exists outside the competitive Civil Service system, but offers the same liberal benefits.
- It thrives on VERSATILITY . . . claiming almost as many Life Master Bridge Players and professional chess masters as does New York City!

There are immediate openings for individuals with the following qualifications:

**1/ COMMUNICATIONS SYSTEMS ENGINEERS** to serve as contact representatives between Security Agency R & D departments and potential equipment users. You will evaluate each model, prior to submission to the user for suitability testing. You will also consider reliability factors, compatibility with existing systems, and performance within the expected environment. Communications Systems Engineers are concerned with all phases of the initial design and development of such experimental equipment—thereafter its fabrication, acceptance testing, and finally the production of the accepted model by industry.

**2/ DATA PROCESSING ENGINEERS** to begin as maintenance specialists for the latest computer equipment built by the Security Agency and leading commercial suppliers. You will also be responsible for training junior engineers and technicians. From this beginning, you will move on to Consultant on the design or modification of special and multipurpose analytical machines, systems engineering in relation to edp R & D, or Engineering Management.

Positions in these categories range between \$6,770 and \$15,665 to start, with regularly scheduled increases, and offer all the benefits of Federal Employment.

If you are a U.S. citizen, and able to make important contributions to the field of secure communications, write to Mr. Edward F. Barr, Personnel Officer (M342-C).

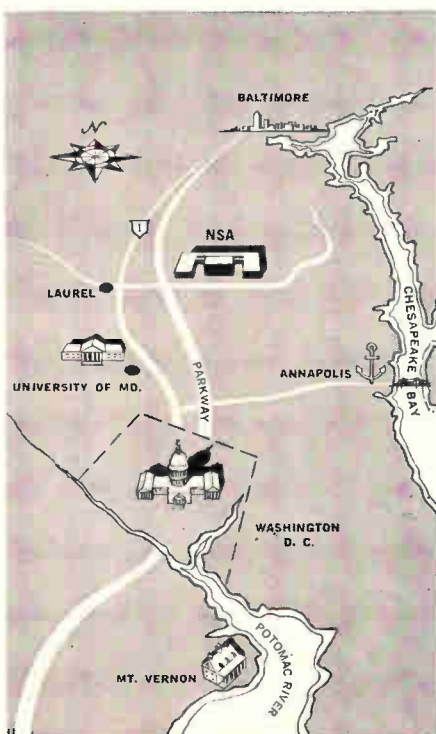

# nsa

**National Security Agency**  
FORT GEORGE G. MEADE, MARYLAND

*An Equal Opportunity Employer*

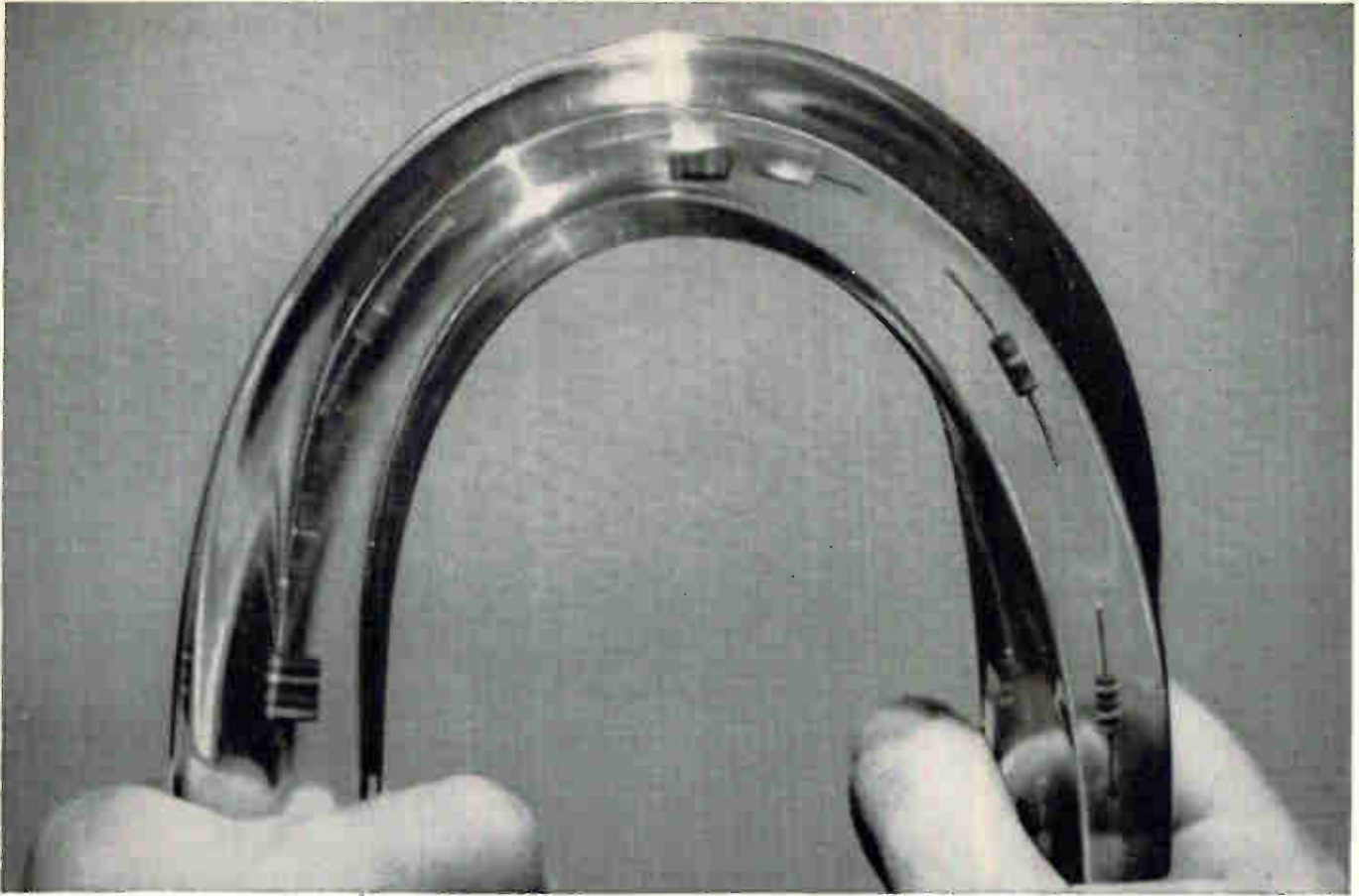

## Tough new silicone speeds potting rates

*Higher strength RTV-615 cures to a clear resilient compound in 15 minutes at 150°C*

RTV-615 is a new addition to General Electric's family of rubber-like potting and encapsulating compounds. It offers the interesting combination of greater strength (1000 psi), toughness, low viscosity (very pourable) and excellent transparency.

RTV-615 lends itself to production line potting since it can be cured tack free in 15 minutes at 150°C, in one hour at 100°C, in 4 hours at 65°C or

24 hours at room temperature. Pot life at room temperature is 4 hours. Mixing procedure has been simplified over previous materials.

RTV-615 is designed to protect assemblies against thermal shock, vibration, moisture, ozone, corona, dust and chemicals from -65°C to 200°C. Its complete transparency permits easy component identification and repair.



**NEW!** RTV's that protect to -150°F. RTV-511 and RTV-560 stay resilient at temperatures that cause other types of potting materials to crack. They also have a higher degree of flame resistance than other RTV's. Excellent for aerospace use, both new RTV's retain full ozone, corona and weathering resistance.



**NEW!** RTV-108 translucent adhesive sealant. Combining easy tube dispensing with powerful adhesion, RTV-108 is a translucent seal and insulator for terminals, joints and other electrical and mechanical sealing jobs. There is no mixing. RTV-108 air cures to a flexible, resilient silicone rubber.



**NEW!** RTV-30 combines low viscosity with high strength. RTV-30 is a new compound with low viscosity for filling small and complicated configurations. Yet it also possesses excellent physical strength, making it a superior flexible mold material for prototypes and short-run production.

If you would like a free sample of one of these new General Electric RTV silicones for evaluation, write on your letterhead, describing your application. For additional information, check reader service card. Section N6107, Silicone Products Dept., General Electric Company, Waterford, New York.

**GENERAL**  **ELECTRIC**

# ANNOUNCING LOW PRICE MICROCIRCUITS

**Fairchild introduces integrated circuits for commercial and industrial applications — priced as low as \$2.55!**

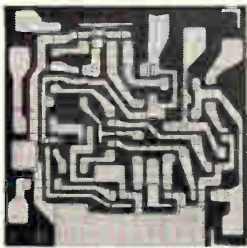

**Low cost** These integrated microcircuits are available from Fairchild at prices meeting the requirements for commercial and industrial use. Functional equivalents of Fairchild's Micrologic and Milliwatt Micrologic elements, they are guaranteed from 15°C to 55°C and are available in volume quantities.

Prices start as low as \$2.55 for a 3-input gate element in quantities of 100 or more. There are two prices on 100-or-more quantities, one for orders of a single device

## PRICE LIST

	1-24	25-99	MIX 100	NON MIX 100
F <sub>μ</sub> L 92329 J-K FLIP-FLOP	9.50	7.60	6.65	6.35
F <sub>μ</sub> L 90529 HALF SHIFT REGISTER	6.50	5.30	4.55	4.35
F <sub>μ</sub> L 90029 BUFFER	3.75	3.00	2.65	2.55
F <sub>μ</sub> L 90329 3-INPUT GATE	3.75	3.00	2.65	2.55
F <sub>μ</sub> L 91529 DUAL 3-INPUT GATE	4.75	3.80	3.35	3.20
F <sub>μ</sub> L 91129 4-INPUT GATE	4.00	3.20	2.80	2.65
F <sub>μ</sub> L 91029 DUAL 2-INPUT GATE	4.00	3.20	2.80	2.65
F <sub>μ</sub> L 92129 EXPANDER	4.00	3.20	2.80	2.65
F <sub>μ</sub> L 91429 DUAL 2-INPUT GATE	4.00	3.20	2.80	2.65

type, another for mixed types. Sample: an order of 150 mixed units (923 Flip-Flop, 995 Dual 3-Input Gate, 900 Buffer) totals \$632.50; 150 unmixed units (the 900 Buffer) total \$390.00. In addition to low price, Fairchild commercial microcircuits offer production and testing economies by combining many components in a single, easy-to-handle package. The 923 J-K Flip-Flop (illustrated) has 15 transistors and 17 resistors in a single monolithic chip. The units are packaged in a low silhouette TO-5 type header with eight or ten leads.

**Broad applications** Because of their low-cost and availability, these Fairchild devices open a whole new range of non-military applications for integrated circuits. These include commercial computers, industrial control equipment, instrumentation and test equipment. Fairchild has already used these units in a line of semiconductor test equipment to be marketed in mid-1964.

**Proven quality** The Fairchild commercial microcircuit line has grown from the industry's oldest and largest integrated circuit capability. Fairchild started producing Micrologic in 1960 and has produced more than 1,000,000 units, primarily for space and defense. Commercial units are manufactured by the same Planar Epitaxial techniques and benefit equally from Fairchild's long experience and rigid production control. Comprehensive data sheet available on request.

**IMMEDIATELY AVAILABLE FROM DISTRIBUTORS/STOCKING REPRESENTATIVES**  
 AVNET Toronto, Canada, 789-2621 BOHMAN Orlando, Fla., 425-8611 CRAMER ELECTRONICS Newton, Mass., WO 9-7700 DART SALES Clarence, N.Y., 874-1212; Syracuse, N.Y., GL 4-9257 DENNY-HAMILTON San Diego, Cal., 279-2421 EASTERN SEMICONDUCTOR Syracuse, N.Y., 454-9247 E.C.E.S.C. Minneapolis, Minn., 888-0102 ENSCO Cedar Rapids, Ia., 366-1591; Wichita, Kan., MU 3-3751; Kansas City, Mo., EM 1-9600; St. Louis, Mo., PA 6-2233 HAMILTON Phoenix, Ariz., 272-2601; Culver City, Cal., 870-0236; Palo Alto, Cal., 321-7541; Seattle, Wash., 282-3836 HYER Englewood, Colo., 761-0754; Albuquerque, N. Mex., 268-6744; Salt Lake City, Utah, 322-5849 MARSHALL Scottsdale, Ariz., 946-4276; San Marino, Cal., MU 1-3292; San Diego, Cal., BR 8-6350; Redwood City, Cal., EM 6-8214 NORVELL Dallas, Tex., FL 7-6451; Houston, Tex., MO 5-0558 POWELL Beltsville, Md., 474-1030; Philadelphia, Pa., 724-1900 SCHLEY Watertown, Mass., WA 6-0235 SCHWEBER Westbury, L.I., N.Y., ED 4-7474 SEMICONDUCTOR SPECIALISTS Chicago, Ill., 623-8060; Minneapolis, Minn., UN 6-3435 SHERIDAN Laharup Village, Mich., 353-3822; Cleveland, Ohio, 884-2001; Dayton, Ohio, 277-8911 SOLID STATE Chicago, Ill., 889-8033 STANDARD Buffalo, N.Y., TT 3-5000 TAYLOR Baldwin, L.I., N.Y., BA 3-8000 TEC-SEL Huntsville, Ala., 534-7304 VALLEY Winter Park, Fla., 647-1216; Baltimore, Md., NO 8-4900; Cherry Hill, N.J., NO 2-9337.

**FACTORY SALES OFFICES**  
 HUNTSVILLE, ALA. 536-4428, 4429 SCOTTSDALE, ARIZ. 946-6583 PALO ALTO, CAL. 321-8780 SHERMAN OAKS, CAL. TR 2-1380; ST 8-8701 ENGLEWOOD, COLO. 761-1735 ORLANDO, FLA. CH 1-2596 OAK PARK, ILL. VI 8-5985 COLLEGE PARK, MD. 773-6868 BEDFORD, MASS. 275-8460 MINNEAPOLIS, MINN. UN 6-3301 ENDWELL, N.Y. 754-2600 JERICHO, L.I., N.Y. ED 4-6500 POUCHKEEPSIE, N.Y. 454-7320 SYRACUSE, N.Y. GR 2-3301 DAYTON, OHIO 228-1111 JENKINTOWN, PENN. TU 6-6623 SEATTLE, WASH. AT 2-5344 CANADA OFFICE: TORONTO, ONTARIO 789-2621

**FAIRCHILD**  
SEMICONDUCTOR

PLANAR: A PATENTED FAIRCHILD PROCESS

FAIRCHILD SEMICONDUCTOR/A DIVISION OF FAIRCHILD CAMERA AND INSTRUMENT CORPORATION/313 FAIRCHILD DR., MOUNTAIN VIEW, CALIF. 962-5011 TWX: 910-379-6435

μL and μLogic are Fairchild trademarks



# A bitter pill

The ills of the electronics industry [Electronics, May 18, 1964, p. 15] have stimulated would-be healers all over the country to diagnose the ailment and recommend cures. A lot of them think the road to health starts in Washington. The Federal government, they urge, should take up the slack in military and defense spending with some other kind of government buying.

We don't agree.

We feel the industry has the best chance of robust health if it cures itself. But for the average company in trouble now, an effective cure demands a complete break with the past. It requires a drastic change in engineering, production and marketing. And management has to take a new look at how it uses its engineers.

Many potentially lucrative applications have not yet really felt the impact of electronics. For example: industrial electronics, medical electronics, education (electronic teaching aids), and transportation (traffic) control. On page 64, for example, a story describes a brand-new industrial area for electronic instruments.

Sure, you've heard all this before. Many military-oriented electronic companies bitterly remember unsuccessful and expensive excursions into these markets. They tried to invade new areas with the same old organization and philosophy they used on defense contracts and they failed.

There was the company that couldn't sell the sensitive electrocardiogram it had developed for astronauts. Doctors are interested in more sensitive instruments but this device was marketed in a package that cost over \$6,000. A conventional electrocardiogram sells for a few hundred dollars. In addition the seller had no clinical experience to offer, no knowledge of how the American Medical Association insists such equipment be advertised and marketed, and no liability insurance to back up the user-doctor. In short the company knew nothing about packaging or marketing a medical instrument.

The criteria for much civilian electronics work is so drastically different from the military that all levels of management need a new orientation. The overriding consideration has to be cost. And military work engenders what one economist calls "a trained incapacity" for minimizing cost.

To crack a new market, the company has to engineer its product simply and ingeniously. There's no place for the flossy flexible circuit that needs twice as many components as a straight-forward one. Then, too, it has to be built economically. You can't pay for the super reliability demanded by the military; you can't even afford such minor luxuries as a military solder joint.

And finally, the marketing men will have to learn new methods; the customers won't be changing theirs.

At the same time a company is making all these adaptations, management ought to start using its engineers more wisely. If you visit a television builder, you'll find the number of engineers on the payroll is low considering the amount of engineering activity. And each engineer has broad interests and can do many parts of the engineering job: design, test, packaging.

In contrast, our survey of engineering employment [May 18, 1964, p. 105] showed that military companies are still seeking out narrow specialists while they are laying off the narrow specialists they hired last year and the year before.

This is typical of the kind of practice electronics companies must change—and quickly—if the industry is to become totally hale and hearty again.

**IN MODULAR POWER SUPPLIES**

# KEPCO APPLICATION VERSATILITY

**MAKES THE DIFFERENCE!**

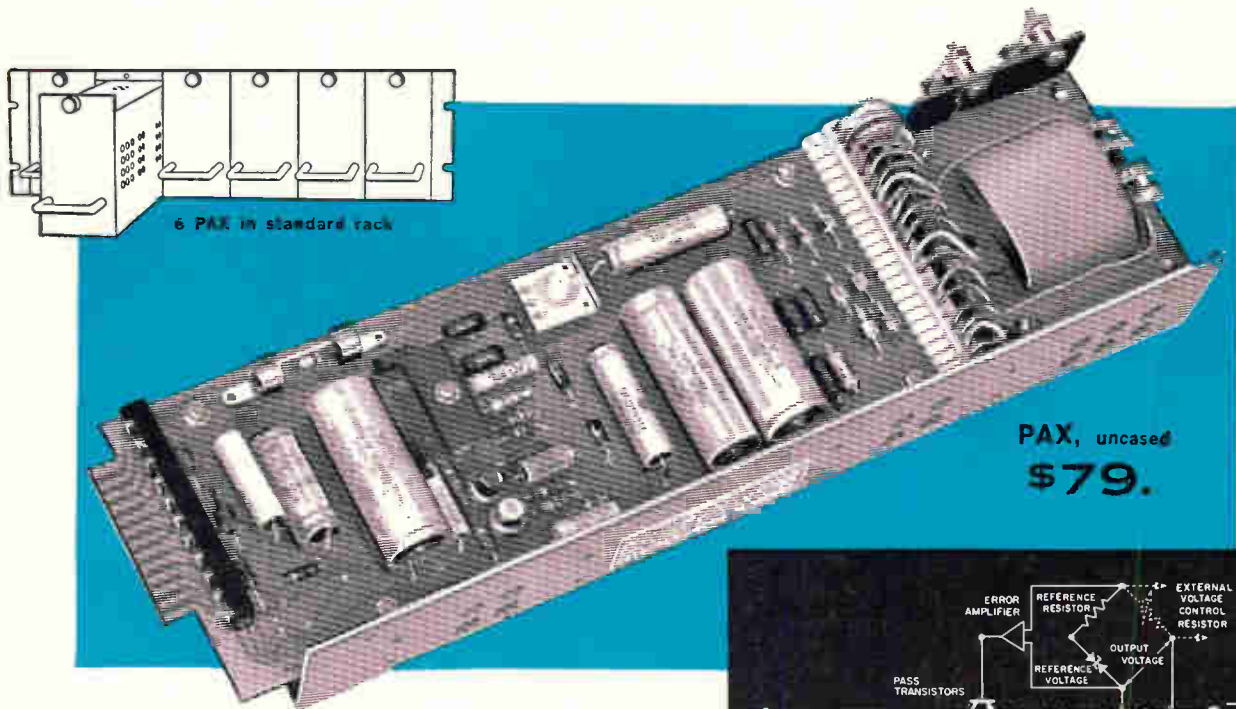

6 PAX in standard rack

PAX, uncased  
**\$79.**



**MODULES**

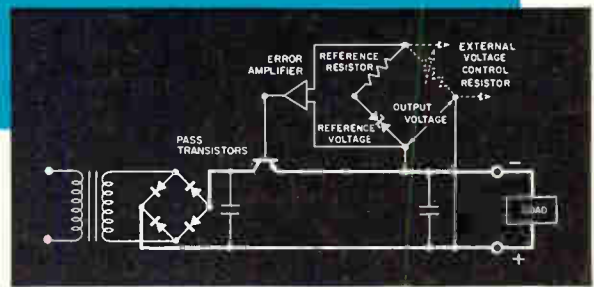

## A KEPCO ADVANCE IN MODULAR POWER SUPPLIES

Versatile electrical and mechanical characteristics of the Kepco PAX Design Group represent a distinctive advance in modular power supplies. Rated for continuous duty, wide range operation, resistance or voltage programming, voltage or current regulation and a choice of mounting methods, PAX modules offer the designer unusual flexibility in his system design. Value engineering has been applied to achieve high performance at competitive prices.

- 0.05% regulation and stability
- Ripple <0.25 millivolt rms
- 50 microsecond recovery time
- 115/230V 50-440 cps input
- Voltage or current regulation
- Patented Kepco Bridge Circuit†
- Resistance/voltage programmable
- Short circuit protected, current limiting
- No voltage overshoot, turn-on, off
- Convection cooling
- Laboratory or systems use
- Open/cased/rack mounting choice

†Applicable Patent Nos. furnished on request

MODEL	DC OUTPUT RANGE		MAX. INPUT AMPS At 125 V AC
	VOLTS	AMPS	
PAX 7—1	0—7	0—1	0.3
PAX 14—0.75	0—14	0—0.75	0.3
PAX 21—0.5	0—21	0—0.5	0.3
PAX 36—0.3	0—36	0—0.3	0.3
PAX 72—0.15	0—72	0—0.15	0.3

See our complete Catalog in **eem** Sec 4000 PAGES 321-352 **EBG**



For complete specifications write for Brochure #146-1053

131-38 SANFORD AVENUE, FLUSHING, N.Y. 11352 • Phone: (212) IN 1-7000 • TWX #212-539-6623 • Cable: KEPCOPOWER NEWYORK

---

# Electronics Newsletter

---

June 1, 1964

## Now transistors for tv receivers

Transistors are about to bite into another traditional market of tube makers: tv sets. When manufacturers introduce their 1965 lines next fall, a lot of them will offer transistorized tv.

Until now, transistorized circuitry has been limited to small-screen sets because a transistor's output wasn't linear enough, nor powerful enough, to drive the picture tube's deflection yoke. Now the problem has been solved by new transistors and new circuits.

Robert Noyce, general manager of Fairchild Camera & Instrument Corp.'s semiconductor division, predicts that **four million transistorized tv sets will be produced in the model year starting June 1, 1965.** He says deliveries of a cheaper silicon transistor for tv design will start in a few weeks. The new transistors, together with a Fairchild-designed circuit, solve the horizontal-sweep problem, he adds, making large-screen sets feasible.

One set manufacturer, the General Electric Co., has already announced a transistorized tv set [p. 88]. Although the news was no surprise, it came sooner than most people had expected. Two other producers have sets in the laboratory: the Emerson Radio & Phonograph Corp. and the Admiral Corp.

## Electronics filling 2 defense gaps

The Air Force is going ahead with plans to develop a warning system to detect sea-launched ballistic missiles [Electronics, Feb. 7, 1964, p. 10]. Companies have been invited to submit letters of interest. They will need a background in data acquisition, signal processing, trajectory analysis, tracking and target analysis, data separation and displays.

The program is aimed at filling one of two gaps in Sage (Semi-automatic ground environment), the system that guards North America against air attack. The other is in the Alaskan network, which is now being automated. The Philco Corp. will soon ship the AN/FYO-9 data-processing and display system that will run the network automatically, from radar indication at a surveillance site to projected display at the control center. The equipment should be operational within a year. Data from the new network will be transmitted automatically to the North American Air Defense Command in Colorado Springs.

## Dual gate extends scope of FET

Applications at higher frequencies are possible with a new two-gate configuration of the field-effect transistor (FET), already one of the most promising new solid-state devices. The dual gate, developed by Siliconix, Inc., differs from the conventional diffused-channel structure which has a single diffused gate.

With the new configuration, the device has only half the parasitic capacitance of the company's latest single-gate device (the 2N3376/77 series), so its gain bandwidth product should be in the 50- to 75-mega-cycle region.

In a TO-18 can, the field-effect device has a capacitance of about 2.5 picofarads, compared with 3.2 pf for the single-gate unit in the same package. The single-gate device had a typical transconductance of 1,500 microhms, so its gain bandwidth product ranged from 30 to 50 Mc.

The most promising applications for the new device are probably in

---

# Electronics Newsletter

---

video and i-f amplifiers. And, because gate current of the dual gate device is only one-third that of the single gate—about 1 nanoampere—the new device also looks promising in instrument applications such as in an electrometer.

## **Seller's market found in Peking**

British companies found the Chinese Communists in a buying mood last month at an exhibition of British scientific instruments in Peking. The Chinese bought \$1.4 million of electronic equipment at the show, the first of its kind since the Communists took over. In a thrifty atmosphere, the buyers took much of the gear right off the displays to save shipping costs of about \$1,000 per order.

A lot of the instrument business was for future delivery. One company went home with \$270,000 in orders after selling and delivering \$15,000 worth from its \$60,000 display.

Purchased by the Communists: digital subassemblies, counters, oscilloscopes, soldering equipment, ultrasonic drilling and precision tank gaging equipment.

## **Gravity gradient gets off ground**

Proof came last month that the National Aeronautics and Space Administration does indeed believe in gravity-gradient stabilization for satellites [Electronics, May 18, 1964, p. 112]. The agency has ordered gravity-gradient equipment, built by the General Electric Co., to orient three spacecraft in the Advanced Technological Satellite program: a 6,500-mile satellite to be launched in 1966 and two synchronous satellites scheduled for orbit in 1968.

According to the \$5 million contract, GE will build a first flight model, two prototypes, two engineering models and instrumentation for measuring performance. The design—long slender rods passing through the satellite—was developed at NASA's Ames Research Center. Each satellite will have two different kinds of dampers at its ends to reduce oscillations: General Electric's eddy-current damper and Bell Telephone Laboratories' magnetic hysteresis unit. NASA hopes to test each one alternately in orbit.

For the important slender rods that cross through the satellite and hold the dampers in place, NASA has specified silver-plated beryllium-copper, instead of Consil 995, an alloy of silver that contains a total of 0.5% of magnesium and nickel. Although Consil 995 is better for reducing thermal bending, it is too difficult to form into rods.

## **The Bunker-Ramo saga: chapter 2**

The Teleregister Corp. has arranged to absorb the Bunker-Ramo Corp., but sold itself in the bargain. When the transaction goes through, the Martin-Marietta Corp. will own 58.5% of Teleregister's stock. Teleregister says it expects to change its name to reflect the acquisition of Bunker-Ramo.

Bunker-Ramo was formed in January by Martin-Marietta and Thompson Ramo Wooldridge, Inc., on a 90%-10% basis. Its purpose was to make computer-control systems; later it absorbed TRW's numerical-control operation, the largest in the field.

TRW also has sold two units to the Harvey-Wells Co.: the Columbus division, which makes electronic language-laboratory equipment, and the closed-circuit portion of its Dage division, including numerical-control facilities.

High frequency

will burn out  
this rectifier

but not this  
Unitrode

Now Unitrode eliminates excessive reverse power dissipated in the diode during turn-off. This means you can reduce ripple and the size of transformers and filters by increasing operating frequency.

At 100 KC, the rectification efficiency of the Unitrode<sup>®</sup> fast-recovery rectifier is only 1% less than at 60 cps. Reverse recovery time is typically 75 nanoseconds . . . and continuous average rectified current ratings are 2 amps even with PIV's of 600 volts!

Unitrode makes this possible by a novel silicon diffusion process that nearly eliminates the reverse current spike during turn-off — and considerably shortens turn-off time. Further, the new fast-switching series has the unique one-piece Unitrode construction that survives long term overloads without damage and is immune to aging effects.

With a hard glass sleeve fused to all exposed silicon surface, the resulting void-free junction cannot be contaminated. And they're no bigger than . . .

. . . this 

Individually inspected, 100% tested, Unitrode fast-recovery rectifiers have to cost more than ordinary rectifiers. But if performance is more important to you than pennies, compare all the remarkable devices based on the Unitrode principle: 3-amp silicon diodes, 3-watt zeners, high-voltage stacks and bridge assemblies. They're stocked by Unitrode representatives nation-wide.

For information, product demonstration and samples, contact UNITRODE CORPORATION, 580 Pleasant Street, Watertown, Massachusetts 02172. Tel: (617) 926-0404, TWX: (617) 924-5857.

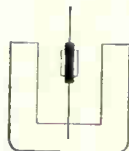

 UNITRODE

radar TACAN Caribbean sonar RDT&E computers GCA Australia Greece Logistics point-to-point Hawaii SSB Ocean surveillance VHF/UHF D/F tropo scatter South America TACDEW Reports OpCon Centers diversity reception London Reliability multiplex Iceland harbor defense data link WCTSS Mediterranean microwave NTDS television VLF air search Far East beacons switching EDP

## **\$13,000 to \$16,000-range positions for Design and Systems ENGINEERS to assume major responsibility for Navy Shore Electronics . . . WORLDWIDE**

The sort of work we are talking about has always been done, of course, but never before NAVAL SHORE ELECTRONICS THROUGHOUT THE WORLD by a single group of talented electronics engineers. Never before by carefully selected teams of professionals with TOTAL RESPONSIBILITY for research, development, test, and evaluation of systems, equipments, components and concepts for such installations as:

1.

2,000,000-WATT VLF TRANSMITTER at Cutler, Maine—the most powerful station in the world. It embodies nearly 3,000 acres, 26 towers nearly 1,000 feet tall, and an elaborate complex of underground cables and helix houses.

2.

WEST COAST OFF-SHORE TACTICAL CONTROL & SURVEILLANCE SYSTEM—an interlocking radar/radio/computer network to provide fast, automatic control of air, surface, and subsurface targets off the Southern California coast.

3.

\$13 MILLION COMPUTER CONTROL CENTER in Hawaii—to coordinate all strategic and tactical information in the Pacific Theatre for real-time solution of command problems.

4.

TACTICAL COMBAT DIRECTION & ELECTRONIC WARFARE PROJECT at Point Loma—a special

radar/microwave/display complex that allows simulated problems in AEW, ECM, CIC, and carrier approaches to be added into actual at-sea exercises off San Diego.

5.

. . . and a never-ending number of similar shore-based electronic installations that are always being designed, constructed, or improved to aid the operating forces.

**As you can see, the magnitude of this assignment is breathtaking, and the opportunity that goes with it is something you simply cannot find anywhere else. Right now, there are openings here in Washington for Division Heads (\$15,665), Design Engineers (up to \$13,615) and Systems Engineers (up to \$13,615) in each of the following areas:**

**Detection & Navigational Aids**—air search, height finding and special control radars . . . aircraft approach and landing systems . . . air traffic control . . . TACAN . . . radar beacons . . . information processing & display . . . distribution and switching equipment . . . underwater ocean surveillance and harbor defense equipment.

**Communications** — transmitters, receivers, transceivers and antennas . . . terminal equipment . . . television . . . data link . . . microwave and electromagnetic wave propagation.

**Special Equipment**—commercial and military data processing & computer systems . . . general purpose test equipment (radio frequency, interference, field intensity, etc.) . . . standardized components . . . repair parts . . . reliability & maintainability programs for all Naval Shore Electronics—Worldwide.

Each division Head has total responsibility for planning and execution of RDT&E in his particular area . . . for program and budget formulation . . . for engineering functional systems & equipment . . . for initiating improvements . . . and for supervising Division activities. Each Design Engineer will be responsible for the contractor guidance necessary to assure proper manufacture of designed items. Each Systems Engineer will have in-the-field responsibility for installation, integration, operation, and maintenance—most such trips taking no longer than a few weeks at a time. In every instance, and on every level since this will be a compact organization, the emphasis must be on getting the job done with a minimum of supervision and red tape.

If you are interested in electronics engineering of the most inclusive nature, and want to work on avant-garde installations all over the world, write—or submit Standard Form 57—to: Industrial Manager Code 110A, Potomac River Naval Command, U. S. Naval Station Annex, Washington, D. C., 20390. All positions include the many benefits of Career Civil Service.

The Navy is an Equal Opportunity Employer.

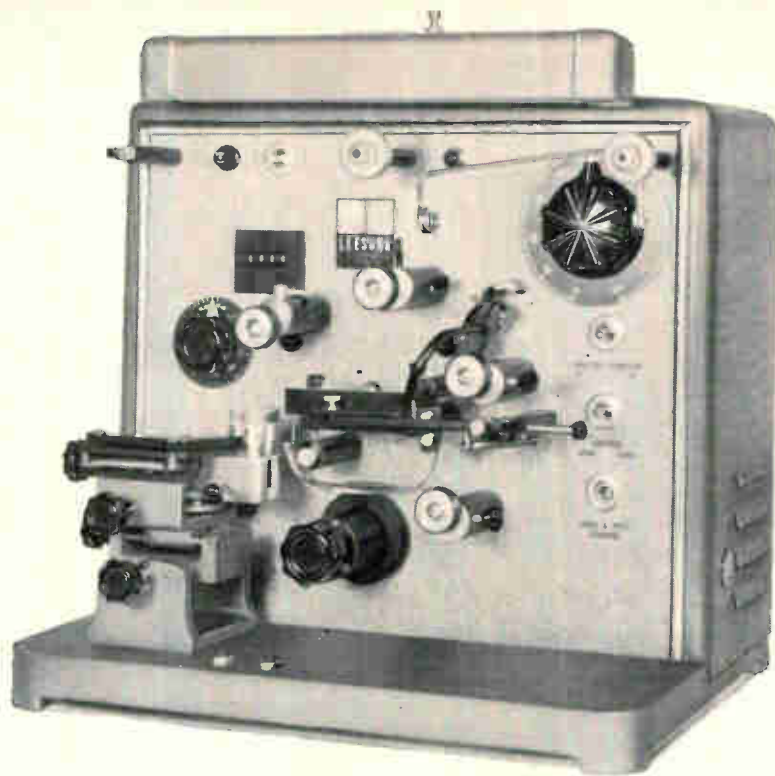

# New from Leeson®...

## Toroidal Coil Winding Equipment

*engineered for greater economy...versatility...reliability!*

Auxiliary Units  
For Toroidal Winders

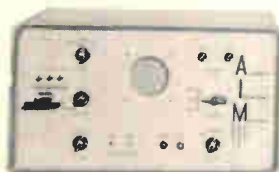

AUTOMATIC INDUCTANCE  
MATCHING COMPARATOR  
for closer tolerance

Inductance range:  
500 Microhenries to  
50 Henries.



PHOTOELECTRIC TURNS  
COUNTER  
for positive turns control

- winds heavy wires on small toroids, due to unique shuttle design and external drive. Virtually eliminates hand winding.
- large 6" shuttle diameter provides: (1) greater wire capacity; (2) faster production in Mag. Amp. work; (3) virtual elimination of splicing.
- loading, winding, and removing or installing cores can be quickly accomplished without removing the specially designed shuttles or sliders.
- speed and ease of set-up make the Leeson TO-133 Toroidal Winder, the ideal equipment for large-scale production plants as well as model work shops.
- top quality materials—and top quality production standards—insure maximum reliability and minimum maintenance requirements.
- finished core size: O.D. 2½", I.D. .055", Height 2".
- wire sizes: AWG 22 to AWG 50.

For detailed information write Leeson Corp., Warwick, R.I.



23B.4.10

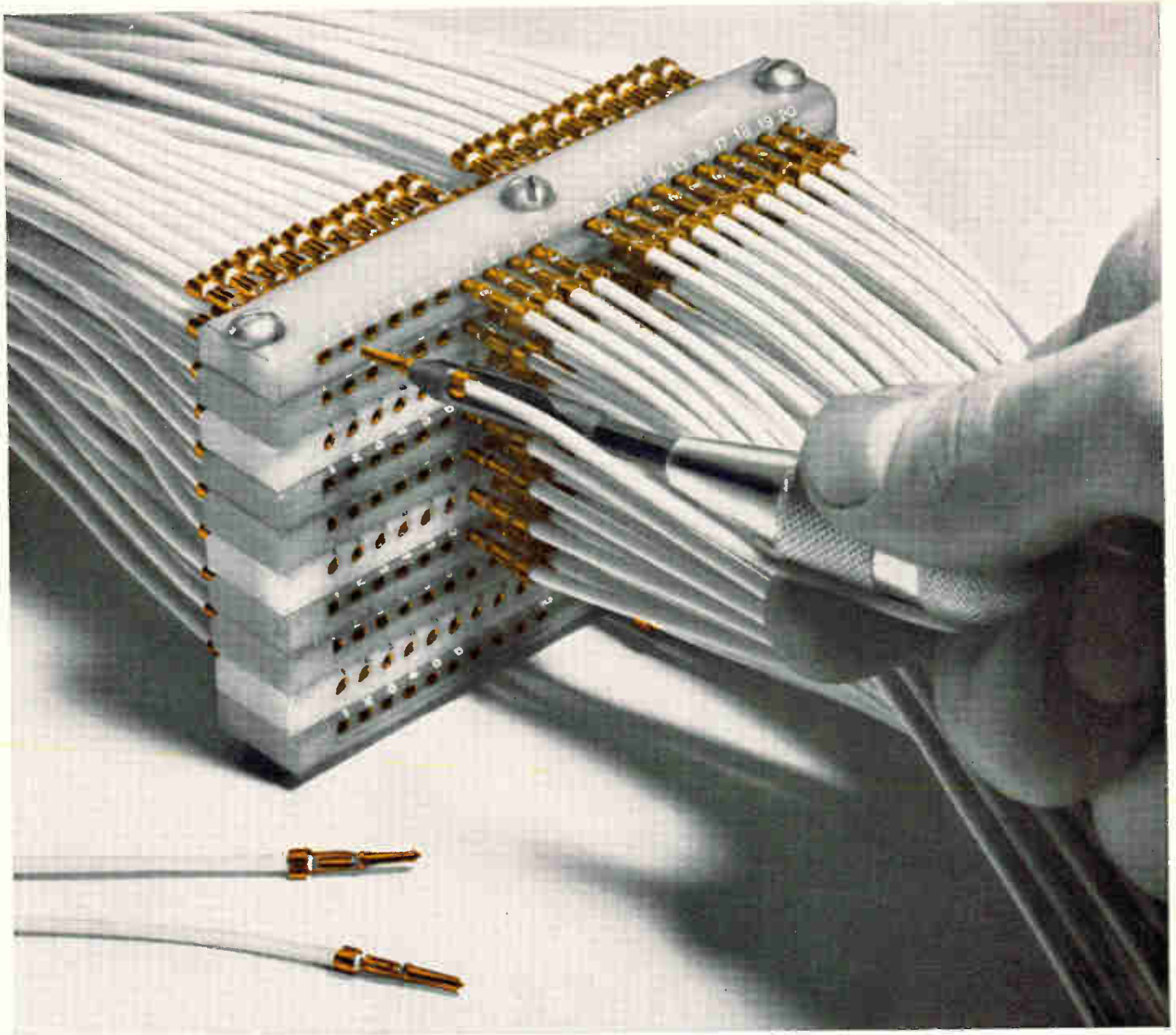

## How small can a pin be?

It can be within a mere few thousandths of an inch of the outside diameter of the wire insulation. Or even less. That's the way we engineer our A-MP\* Taper Pins.

Anywhere the wire fits, our pins fit. That's the kind of density that gives you the extra design space you need.

With nominal retention strength of 25 pounds, our taper pins assure peak mechanical and electrical characteristics. Even when subjected to temperature cycling of  $-85^{\circ}\text{F}$  to  $+500^{\circ}\text{F}$ , and being vibrated at 150 cps, 20 g accelerations, these taper pins hold fast. And they become better with age—joint resistance decreases, while joint disengagement forces increase. Combine this with a taper design that makes pins self-cleaning and self-locking and you've got reliable performance under the toughest conditions.

Want further assurance? Check these features:

- Our matched crimping tools eliminate cold solder joints, burnt and brittle insulation
- Automatic application for lowest installed cost

- Pre-insulation prevents flash-over and possible shorting
- One piece solid molded blocks and two piece for customer assembly
- Standard configurations, 10, 20 and 30 cavities

So why look further? We have the most complete line of taper products in the industry. Pins stamped and formed, uninsulated and insulation piercing types, screw machine with insulation support and pre-insulated types. Plus all kinds of companion items, such as vertical entrance blocks, taper bus bar and taper tab blocks. Write today for complete information.

\*Trademark of AMP INCORPORATED



A-MP\* products and engineering assistance are available through subsidiary companies in: Australia • Canada • England • France • Holland • Italy • Japan • Mexico • West Germany



## Microelectronics

### The last breakthrough?

A technique that was developed to isolate elements in integrated circuits and overcome the problem of parasitics [Electronics, Apr. 6, p. 29] has paid an unexpected bonus. Radiation, Inc., of Melbourne, Fla., has found it useful in forming small megohm resistors.

This electronic serendipity is an outgrowth of the "waffle wafer" isolation process recently announced by Uryon S. Davidsohn of Radiation, Inc. [p. 8]. With this technique, isolation moats are etched into the surface of a single-crystal silicon slice, which is oxidized, forming a thick layer of silicon dioxide. An epitaxial layer of polycrystalline silicon is grown on top of the oxide. The single crystal is lapped back until the moated regions reach the surface. Then conventional diffusion and photoresistive techniques are used to form the integrated circuits on the exposed crystal surface.

The technique can be used to form resistors as well. The high intrinsic resistivity of the polycrystalline silicon allows formation of small, high-value resistors. According to Davidsohn, these polycrystalline resistors will be used in the micropower circuits that the company is developing for aerospace equipment. Resistance values in the megohm range—a neces-

sity in micropower circuitry—have been provided up to now by diffusion techniques. But they required large areas to achieve the desired high resistance.

**The Motorola way.** Another company that has succeeded in isolating integrated circuit components — Motorola, Inc. — described its process for the first time at its integrated circuits course last month. It turned out to be strikingly similar to Radiation's process.

Motorola forms a low-resistivity layer on top of a single-crystal silicon wafer and grows a one-micron layer of silicon dioxide on top. A mirror image of the desired isolation pattern is then etched into the wafer and an isolating layer of silicon dioxide—usually 1 to 5 microns thick—is formed. The wafer is then placed in an r-f furnace and polycrystalline silicon is deposited on the isolating oxide. Finally, the structure is flipped over and the excess single-crystal silicon is removed—by lapping or etching—leaving completely isolated n regions. It is then ready for standard processing.

**Last breakthrough.** In both the Radiation and Motorola circuits, breakdown voltage between collector and substrate exceeds 1,000 volts, and the parasitic capacitance between circuit elements is sharply reduced. This allows a sharp increase in the speed of digital circuits and the frequency of linear circuits.

The solution to the isolation

problem is seen by some observers as the last breakthrough in the present generation of integrated circuits—circuits in which components are still recognizable in the silicon chip. The observers feel that with the elimination of parasitics, further development will consist primarily of refinements.

Isolation techniques recently announced by the Signetics Corp. and the Autonetics division of North American Aviation, Inc., are believed to be similar to the Radiation and Motorola methods.

### Optical coupling

Further evidence of the growing practicality of optoelectronics [Electronics, Jan. 24, 1964, p. 5] was given in an encoder delivered to the Air Force last month, and by a new instrumentation system being developed by a California company.

The encoder, an integrated-circuit model developed for pulse-code-modulation telemetry by Texas Instruments Incorporated, has an optoelectronic multiplex switch as an external plug-in module.

The switch consists of a gallium-arsenide electroluminescent diode emitting light on a silicon transistor. This two-element device replaces an integrated circuit of 17 diffused components plus an external capacitor.

**Less noise.** Because the light emitted by the diode (rather than an electrical path) couples the two elements, the input signal and the switch-driving current are isolated. TI says that transient switching noise is less than 1% that of a conventional solid-state multiplexer.

Further indications of the new device's advantages were given at the National Aerospace Electronics Conference, at Dayton, Ohio, by Walter S. Chambers, of the Air Force Avionics Laboratory at

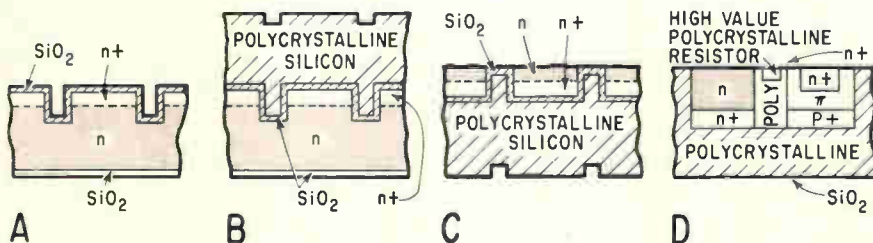

The three steps in Motorola's process of isolating integrated circuit components are shown at left (A,B,C). At right (D) is part of a circuit by Radiation Inc., showing the structure of a high-value resistor.

Wright-Patterson Air Force Base.

Chambers compared the optoelectronic switch to a silicon integrated circuit, with these results: power dissipation is 36 milliwatts compared to 45 mw; on-resistance is 25 ohms compared to 60 ohms; leakage to ground is 0.01 nano-ampere, compared to 10 na; chopping rate for a 2.5-volt signal is d-c to 30 kilocycles, compared to 6 to 50 kilocycles for the integrated circuit.

The optoelectronic multiplexer serves 8 of the 16 analog channels in the TI encoder (a second unit can be plugged in). The encoder, which also has 5 digital channels, contains 150 digital and 100 linear circuits.

**Ideal couple.** Chambers pointed out that at present, an ideal combination for a light-coupled circuit is a gallium-arsenide diode as the light source and a silicon phototransistor. Both are long-lived and their characteristics are compatible. The diode, for example, emits light at 9,000 angstroms, the wavelength best detected by a silicon junction.

**Cutting the cabling.** Optoelectronic coupling will also be used in an instrumentation system being developed by Aerojet General Corp. Designed for a rocket test stand, it will acquire analog data from 48 transducers, convert the data to digital form at a rate of 20,000 samples a second, and transmit it serially.

The test stand will be completely isolated from ground. The output signals will be coupled to coaxial cable by light from a photodiode. Only two coaxial cables will be used to link the test stand to the main control centers. Aerojet plans to build the working system out of integrated circuits.

---

## Microwaves

---

### Wireless power

A solution to the problem of directly converting microwave power to d-c for transmission of power may spring from that old reliable

workhorse, the klystron. Work at the electron tube division of Litton Industries, Inc., indicates that an efficient rectifier can be made from a four-cavity electrostatic klystron similar to the company's electrostatic amplifier klystron [Electronics, Dec. 28, 1962, p. 36].

The rectifier is constructed much the same as its amplifier counterpart except for the output cavity, or accelerator. The electron beam is bunched in the normal manner, but the bunches are arranged to absorb r-f energy at the accelerator instead of yielding it.

**60% efficiency.** Computer analyses of the S-band klystron rectifier indicate that an over-all efficiency of about 60% can be achieved with a 2.6-kilowatt output. Power-to-weight ratio is 150 watts per pound. One disadvantage of the present tube is the relatively high output voltage of 5,200 volts. Spaceborne equipment usually requires lower voltage.

The development is potentially significant to the emerging technology of electronic power transmission. Power transfer by microwave offers simplicity and high efficiency on earth, and in space it could provide a means of supplying power to manned vehicles and space platforms. In effect, a microwave power system could be the "long cord" that wags have long suggested as a solution to the spacepower problem.

While microwave power generation is approaching practical levels—thanks to microwave tube developments nurtured by military requirements—there is much more work to be done to convert the microwave power to useful forms of energy, such as d-c.

Other approaches to microwave rectifiers include Purdue University's arrangement of arrays of semiconductor rectifiers to intercept the power beam directly without recourse to an antenna; the Raytheon Co. closed-space thermionic diode and a magnetron rectifier; the Lockheed Aircraft Corp. "multipactor" rectifier, a device using a discharge phenomenon that has been used in microwave switching. Of these, the solid-state

array is the most efficient—up to 70%—but it can't handle high power with existing components.

**Not through space.** As for the possibility of using microwave or laser beams to power flights between two points in space, a group at the Air Force Aero Propulsion Laboratory of Wright-Patterson Air Force Base has quietly dropped that approach after plugging in some actual numbers. The engineers took one look at the weight, antenna size and design complexities required, and concluded that these would never be practical for power subsystems. The Air Force, however, still has hopes of transmitting power from earth to space vehicles.

---

## Companies

---

### Going Dutch

The Netherlands' biggest electronics company is expanding its holdings in the United States.

The Consolidated Electronics Industries Corp., which is controlled by the Philips Gloeilampenfabrieken, N. V., of the Netherlands, has arranged to acquire Atlas General Industries, Inc. Atlas recently acquired the Ohmite Manufacturing Co., a Chicago-based maker of electrical resistance products. Atlas also invested \$6 million in the Digitronics Corp., with rights to convert its holdings into enough common shares to control Digitronics, a maker of data-processing equipment.

Consolidated Electronics also announced plans to absorb the Kulka Smith Electronics Corp. in Mt. Vernon, N. Y., and the Dialight Corp., a Brooklyn, N. Y., maker of signals and relays. Atlas owns 52% of Dialight's stock, and has arranged to buy 44% of Kulka Smith. When present plans take effect, Consolidated Electronics expects to own 100% of both Dialight and Kulka Smith.

Atlas is based in Washington and manufactures automated packaging machinery and apparel.

**Cost \$18 million.** The Dutch in-

dustrial giant controls its American holdings through the U. S. Philips Trust, whose beneficiaries are the stockholders of the Dutch concern. Philips formed its U. S. trust just before World War II to protect the company's holdings from the Nazis.

To finance the recent acquisitions through stock, and to maintain its holdings at 33% of Consolidated Electric, the U. S. Philips Trust put up about \$18 million.

The roster of Philips companies in the U. S. includes North American Philips, Inc., The Amperex Electronics Corp., Ferroxcube Corp., Technical Electronics Co., Philips Electronics and Pharmaceutical Industries, Industrial Circuits Co., Philips Metalonics and Philips Electronic Instruments.

## Military electronics

### Disappointing debut

Aircraft designers found some consolation in the bittersweet ceremonies that marked the rollout of the first XB-70 supersonic aircraft at North American Aviation, Inc., on May 11. Even if the Department of Defense holds to its decision never to build an operational version, the aerodynamic and power systems lessons learned will probably help speed the design of the proposed supersonic transport plane (SST).

But as a project that would have advanced the state of the art in airborne electronics, the XB-70 program is a near-bust so far. Secondary electronics systems, designed to help the pilot land the monster aircraft, are likely to find their way into commercial aircraft like the SST. But the automatic flight control system and the sophisticated fighting systems have been shelved along with the RS-70, the operational version of the experimental craft.

During its long and stormy gestation period, the XB-70 was stripped of better than half the electronics originally planned [Electronics, Feb. 1, 1963, p. 18].

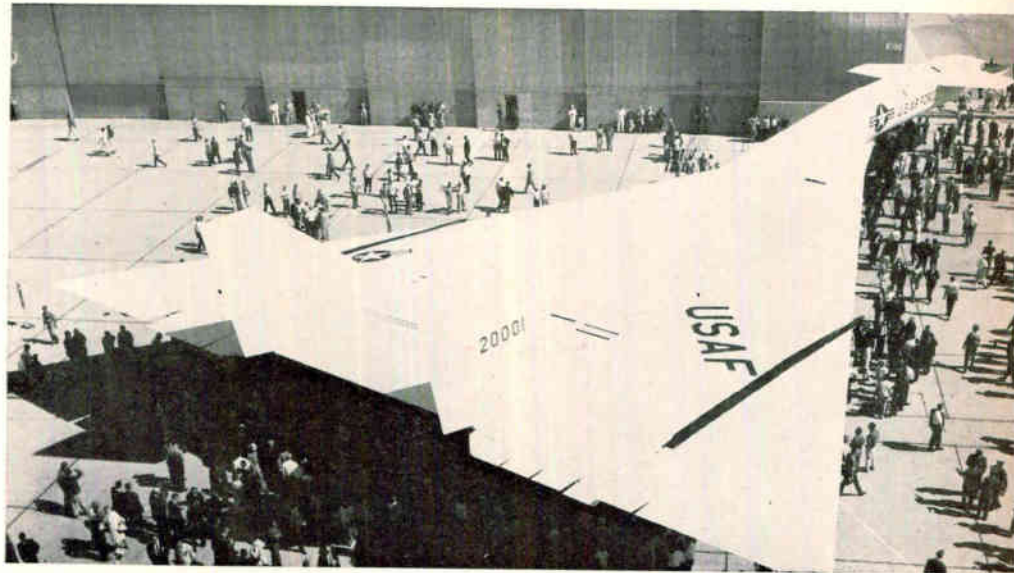

XB-70 rolls out of hangar in Palmdale, Calif. One more model will be made before the \$1.5 billion program is terminated.

**Flight control.** While the XB-70 does not have automatic flight controls, it does have an electronic flight-augmented control system built by the Autonetics division of North American Aviation. This system, consisting of sensors, two analog computers, and servo, helps the plane fly steady and prevents the pilot from putting it into structurally unsuitable maneuvers. The XB-70 also has a central computer for air-data built by the AiResearch division of the Garrett Corp. It consists of an electromechanical analog computer and a variety of transducers to monitor and display operating conditions.

The flight control system, and most of the other electronic gear actually in the XB-70, was conceived six years ago and, by today's criteria, is fairly conventional. Standard vhf and hf communications systems are installed, for another example.

**Convertible systems.** Two innovations that may be applied to civilian aircraft are a computer-controlled anti-skid device and a fail-safe system for steering the nosewheel. They are designed to reduce blowout and skidding problems on landing, and to shorten landing distance. Both were developed by North American Aviation and built by Cleveland Pneumatic Industries, Inc.

The anti-skid device, based on a solid-state analog computer, adapts to runway conditions. With it, says an NAA engineer, braking is as efficient on wet or icy surfaces as on dry concrete.

**Fifth wheel.** The computer is fed data on the plane's rolling speed from an unbraked extra wheel on each landing gear. It also gets data on wheel load and brake torque. From this, the computer can determine ground friction, predict skids and then control brake pressure to avoid the skid.

The same principle could be applied to skid controls for trains, trucks and other heavy vehicles as well as the SST.

The nosewheel steering system, also solid-state, senses and avoids conditions that might result in steering accidents—such as the plane's veering off the runway.

The design that NAA unsuccessfully submitted in the SST competition included the landing system. Also included was the a-c electrical system (airplanes conventionally use d-c) and the method of cooling the electronics compartment. In the XB-70, a three-inch thick, air-breathing wall insulates the equipment and its operators from the heat of the aircraft skin, which can go as high as 620°F.

North American lost out to the

Boeing Co. and the Lockheed Aircraft Corp. in the supersonic transport competition. However, the National Aeronautics and Space Administration plans to watch the XB-70's flight performance closely to obtain design information for the SST.

### Packaged airfield

In a few weeks, trucks will begin to arrive at an airfield in the boon-docks of Eglin Air Force Base, Fla., to unload a complete terminal-area airfield control system that can be flown to any spot in the world and set up for operation in eight hours.

Such equipment fits in with the stress on more transportable, flexible equipment for limited warfare.

The system—known variously as the emergency mission support system, 482-L, and by the Air Force stock designation AN/TSQ-47—is supposed to be smaller and more reliable than existing equipment and easier to maintain.

According to the systems engineering contractor, the Aerospace Systems division of the Radio Corp. of America, the AN/TSQ-47 performed satisfactorily during company-managed tests at Fort Devens, Mass.

So far, RCA has built three 482-L systems under a fixed-price contract. Results of the tests, and the emphasis placed by the Pentagon on limited warfare, will determine how many more systems will be built; there has been talk of 10 to 14.

**Capacity tripled.** Search radar makes contact with incoming planes as far out as 80 miles and turns them over to terminal air traffic control, which is supposed to handle 24 arriving and departing aircraft simultaneously. The present system controls only eight planes at a time.

Even in bad weather, with various types of aircraft arriving at random, the AN/TSQ-47 should be capable of handling a landing and takeoff rate of one plane every 2½ minutes. For limited periods of concentrated traffic of identical aircraft, this rate may be cut to one a

minute. The AN/TSQ-47 triples the navigation aids and point-to-point communications capability of existing systems, and doubles that of present air-ground communications.

**Fed by surveillance radar.** Major subsystems include the AN/TPS-35 surveillance radar—a repackaged UPS-1—which feeds into the TSW-5 radar approach and traffic control center (Rapcon), the TRN-17 Tacan navigation system, the TPN-14 precision approach radar, the TSW-6 control tower and the TSC-23 communications system.

**Operational tests.** Starting July 1 the Air Proving Ground Center of the Air Force Systems Command will itself test the 482-L, making all possible demands on it for about four months.

Some time in November, the Air Force Communications Service will load an entire system into six C-130's—half the number needed for existing systems—fly it to a new place, set it up and test it again. It will ultimately operate the 482-L for the Tactical Air Command, the principal combat command for limited wars.

The TPS-35 will be tested for ability to withstand electronic jamming. A KC-135 jet plane, as well as ground-based vans, will be equipped with jammers to test surveillance radar for such enemy jamming tricks as swept noise, barrage noise, continuous wave, sync-non-sync pulse, spot bundle and corridor chaff.

**One test dropped.** Testing of the Racep (random access and correlation for extended performance) communications system has been dropped from the 482-L system—for the time being at any rate—due to a ruling by the Joint Frequency Allocations Board of the Defense Department. The board feared that Racep might cause interference problems with other parts of the 482-L system. The Air Force has appealed the ruling on the ground that proper spectrum management can avoid interference. Racep was developed by the Martin Co. of Orlando, Fla., a division of the Martin-Marietta Corp.

After the military tests begin, an-

other 482-L system will be moved into Eglin and set up for training purposes. RCA will conduct the training project under contract with the Air Training Command.

---

## Computers

---

### Retired at 14

Too old to keep up with the younger crowd, 14-year-old SEAC has been retired. The National Bureau of Standards Electronic Automatic Computer, born in 1950, was the first internally programmed digital computer in operation in the United States.

Originally developed to help the Air Force attack massive logistic problems, and also used in the design of the first H-bomb, SEAC is being retired because today's problems require faster speeds and larger memories.

The original mercury delay-line memory held 512 words of 45 bits each, with an access time of 168 microseconds per word; this was later increased to 1,024 words. The original Williams electrostatic storage-tube memory of 512 words was also doubled. The system occupied 680 cubic feet, and used 1,625 6AN5 tubes and 24,000 germanium diodes.

SEAC was used in a variety of computer research projects. The original one-megacycle SEAC circuits were adapted for use in DYSEAC, a direct descendant completed in 1954, which was further modified for a third-generation processor called PILOT.

Although officially retired, SEAC will continue operation until this fall, when PILOT will take over. PILOT is almost complete except for its memory, which has not yet been installed.

There are no plans yet for disposing of SEAC; one of its panels may go to the Smithsonian Institute in Washington. One of the original magnetic-wire recording cartridges used with SEAC has already been given to the Smithsonian's Museum of Science and Technology, which on Oct. 3 was

# FACTS...



*about today's most  
advanced solid state  
telegraph relays*

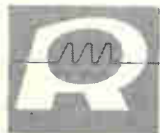

**RADIATION**  
INCORPORATED

## *Are all solid-state relays alike?*

No. Some are transistorized versions of mechanical units, while others are partially solid-state. Radiation Telegraph Relays are all solid-state. There are no moving parts.

## *Why invest in solid-state relays?*

Because they eliminate routine maintenance, require no adjustments, and cut costly downtime and service calls.

## *How long will they operate under normal conditions?*

Indefinitely.

## APPLICATIONS . . .

### *Which mechanical relays can solid-state units replace?*

All known types . . . except those rare applications where no solid-state device can be used.

### *How many kinds would I have to stock?*

Only three: Radiation supplies polar, neutral and universal types.

### *Can I simply plug in your relays and expect them to work?*

Yes. But because there are so many different wiring options, an adapter plug may be required to match your particular system.

### *How do you power Radiation Relays?*

You don't. A unique circuit (patent applied for) allows the unit to operate on input current . . . the signal itself supplies the power.

## TECHNICAL . . .

### *What are the features of Radiation Relays?*

Non-polarized output contacts, high MTBF . . . 73,000 hours of actual field test without failure, high speed . . . up to 2400 bits/second, low distortion . . . less than 1% at 1000 bauds, and low leakage . . . less than 5  $\mu$ a at 130 volts. The units provide long operating life with extremely high reliability, and are designed with special protective circuitry.

### *What type of protective circuitry?*

Thanks to a unique Radiation design, the units are highly resistant to spikes and overvoltages. Not only do they provide a cleaner telegraph signal, but they are also protected against destruction caused by abnormal line conditions.

### *Suppose a Radiation Relay is badly overloaded . . . how do I check it out?*

We can supply our Model 7110 Solid-State Relay Tester. Incidentally, it comes with an adapter for use with electromechanical units, too.

### *What if the unit's actually damaged by abnormal conditions . . . do I have to throw it away?*

Absolutely not! Due to modular construction Radiation Telegraph Relays are repairable.

## QUALITY ASSURANCE . . .

### *Are your relays guaranteed?*

They certainly are. Radiation warrants Neutral Model 9214 and Polar Model 9212 against all defects of performance for a year after shipment . . . providing they're used under normal conditions.

### *How can I prove the superiority of Radiation Solid-State Telegraph Relays?*

Simply phone or write Product Sales Manager at Radiation Incorporated, Products Division, Dept. EL-06, Melbourne, Florida. We will supply technical information, and, if you wish, have a Field Engineer provide a relay to test on the line of your choice.

*Why not call today? Prove to yourself that Radiation Relays assure higher circuit efficiency, lower cost operation and dependable service!*

given another old-timer, the 12½-year-old Univac I, retired from service with the Census Bureau.

---

### Instrumentation

---

#### Faultfinders

Early next year the Air Force will get its first general-purpose automatic tester for electronics systems. The device, being assembled now by the electronics and space division of Emerson Electric Co., St. Louis, results from a study contract granted the company last year, to determine which of about 50 building blocks were needed to check and maintain the largest amount of electronic equipment.

For more than five years the Air Force has been shepherding the development of a General Purpose Automatic Test System (GPATS) to cope with the growing complexity of existing and future electronics systems.

**Pick a block.** To test a system, a programmer-comparator selects the building blocks needed for a particular test and tells an operator what manual operations are required. Universal decoder memory units connect the programmer-comparator with the building blocks. Information is transferred to each building block by a 50-line common-program bus.

The blocks include 14 programmable stimulus generators, 16 response monitors, 10 programmable power supplies, 3 loads and 6 switching units. By uniting the programmer-comparator with selected building blocks, a flexible test system is developed that can select and control any of the building blocks by following instructions fed through punched tape or by manual inputs.

The system can compare a measured result with a programmed limit and store the test results. By comparing a series of test results with a pre-established test pattern it is possible to determine what additional steps are required to complete the testing procedure or to isolate a fault.

**Cost factor.** The series of modular units which comprise the tester can be interchanged depending on the electronics system being checked. Since GPATS can be used on a wide range of systems it is expected that its versatility will help hold down costs of development, design, programming and training.

**Time-sharing tests.** Development of another testing system, the Versatile Automatic Test Equipment, has been sponsored by the Newark (Ohio) Air Force Station at the Hughes Aircraft Co. It will be used to test and repair inertial guidance systems for missiles. A digital computer with a time-sharing mechanism will enable it to check a number of devices simultaneously.

The computer can track down the cause of a malfunction, locate the component at fault, and flash instructions on a screen to show what part must be replaced. About 70% of the equipment is usable for any system. The other 30%—the interface equipment—is designed for the system under test and it is operational only with that system.

---

### Advanced technology

---

#### High on ions

Now electronics is propelling machines through the air.

Alexander P. de Seversky calls his new development an ionocraft. He says the concept may be used in a craft that can fly like a helicopter at over 300,000 feet. Flying above the weather is a must for this type of craft, because moisture and electricity don't mix.

**Flying grid.** The vehicle being test-flown consists basically of a nine-foot-square wire grid with a wooden frame, from which are suspended discharge electrodes, polarized negatively. The electrodes release ions that travel to the positively polarized grid body. En route, the ions collide with air molecules, causing air motion that provides lift.

The grid is divided into four sections, whose electrical potential can be varied with a control stick

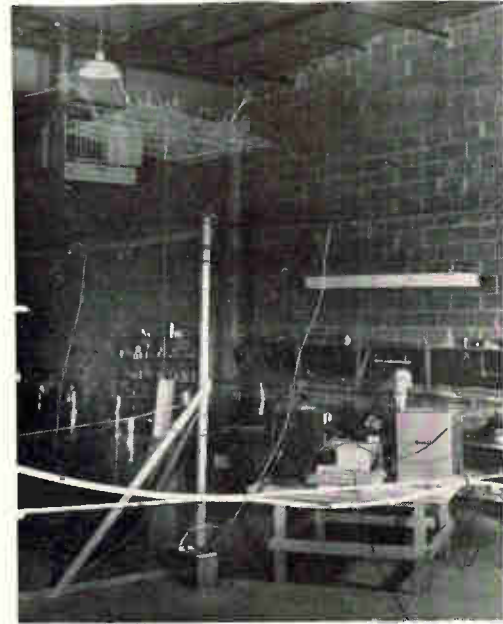

De Seversky watches his ionocraft hover above its power supply.

to control the craft's motion. With 60 watts of power, the test craft can support a 200-gram payload—double its own weight.

De Seversky, who is president of the Electronatom Corp. of New York, is building a 20-foot-square version. It will carry its own power plant, consisting of a miniature high-voltage generator operated by transistors.

---

### Components

---

#### Doubling planar frequency

Texas Instruments Incorporated has substantially reduced the size of its germanium planar transistors. This is part of a program to produce transistors with higher frequencies than the TIX-3032 [Electronics, April 4, p. 62] that had an emitter area of 2.5 sq. mils and a collector-base junction area of 16 sq. mils. A new structure being worked on in the laboratory has an emitter area of ¾ sq. mil and a collector-base junction of 6¼ sq. mils.

The company expects that the reduction in size of the transistor will give performance equivalent to its present 2N2999 and TIX 3024 mesa amplifier transistors: minimum cut-

# FOUR NEW HOT LITTLE NUMBERS

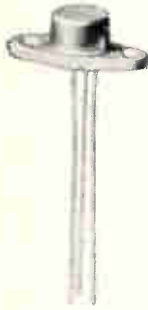

2N3212



2N3213



2N3214



2N3215

## FROM DELCO

Now from Delco Radio come four remarkable new miniature Nu-Base† transistors for people who need high current, high voltage and fast switching in a very small package.

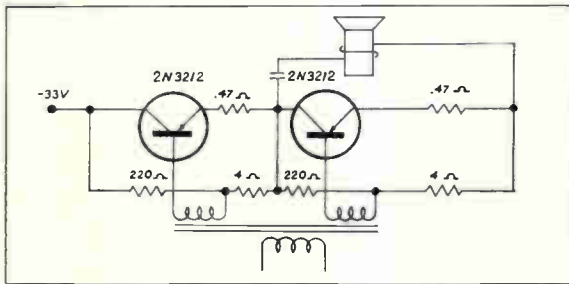

Miniature Class AB audio power amplifier:  
Maximum RMS power output 18 watts at 200 cps

Each of these devices is rated at 5 amperes, maximum continuous collector current. Ranging from 30 to 80 volts, their V<sub>CEO</sub> ratings make them especially useful where high voltages and high currents are encountered. In addition, their relatively low saturation resistance and high speed give them excellent efficiency and reliability for switching applications.

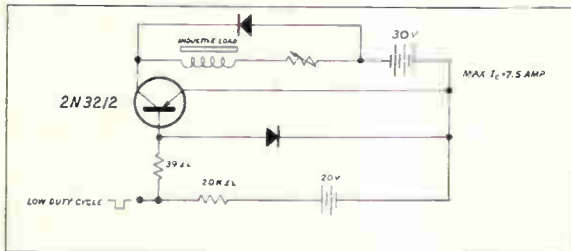

Miniature Solenoid Driver: Excellent high current gain of 2N3212 enables intermittent operation of solenoids at high currents such as 7.5 amperes. Duty cycles of 1 millisecond at 15 millisecond repetition rates are typical.

†Delco's name for drift field non-uniform diffused base construction.

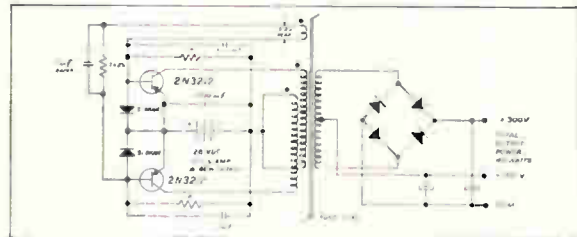

Miniature converter in which 2N3212 high gain, high current and fast switching speed characteristics provide a 40-watt output at an efficiency of over 87 percent.

The Delco Nu-Base construction features a husky element with built-in protection from current "hot spots" to assure freedom from secondary breakdown over the operating range.

These units will dissipate over 5 watts at 71°C case temperature, operate over a range of -65°C to 110°C and lend themselves easily to automatic insertion—all this in a TO-37 package.

The shortest distance between you and more detailed information is a call or letter to one of our sales offices or your Delco semiconductor distributor. Right now is as good a time as any.

TYPE	2N3212	2N3213	2N3214	2N3215
V <sub>ceo</sub>	100	80	60	40
V <sub>ceo</sub> @ I <sub>c</sub> =20ma	80	60	40	30
h <sub>FE</sub> @ 3A	30-90	30-90	30-90	25-100
V <sub>ce</sub> (sat) @ I <sub>c</sub> =5A	0.5v	0.5v	0.5v	0.5v
V <sub>ce</sub> (sus.) @ I <sub>c</sub> =3A	80	60	40	30
Conditions for V <sub>ce</sub> (sus.)	Pulse Width = 1.4ms Duty Cycle = 4% Inductance = 6mH			

Operating temperatures = 110°C max., -65°C min.; max. storage temperature = 125°C.

Union, New Jersey\*  
324 Chestnut Street  
MUrdock 7-3770  
AREA CODE 201

Detroit, Michigan  
57 Harper Avenue  
TRinity 3-5560  
AREA CODE 313

Palo Alto, California  
201 Town & Country Village  
DAvenport 6-0365  
AREA CODE 415

Santa Monica, California\*  
726 Santa Monica Blvd.  
LUpton 0-8807  
AREA CODE 213

Syracuse, New York  
1054 James Street  
GRanite 2-2668  
AREA CODE 315

Chicago, Illinois\*  
5151 N. Harlem Ave.  
775-5411  
AREA CODE 312

General Sales Office\*: 700 E. Firmin, Kokomo, Ind., Gladstone 2-8211—Ext. 500 • Area Code 317

\*Office includes field lab and resident engineer for applications assistance.

# DELCO RADIO

Division of General Motors, Kokomo, Indiana

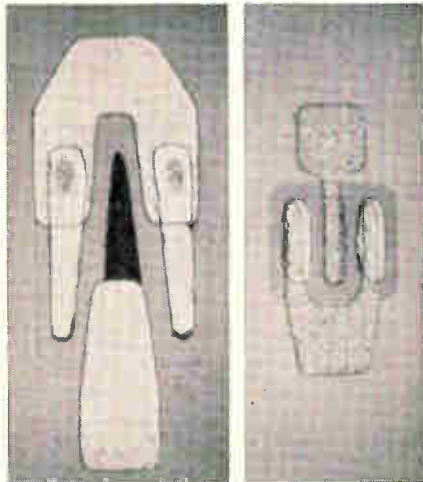

The TIX-3032 (left) and its substantially smaller successor

off frequency ( $f_T$ ) of 1.4 Gc, minimum  $f_{max}$  of 4 Gc and a typical noise figure of 5 db at 1 Gc. This compares with 500 Mc, 2 Gc and 3.5 db at 200 Mc, respectively, for the TIX 3032. The ultimate goal of the program is to develop planar amplifier transistors with minimum  $f_T$  greater than 2.4 Gc, minimum  $f_{max}$  greater than 5 Gc and typical noise figure of 7 db at 3 Gc. The goal, which may be reached in about a year, provides characteristics presently not achievable with mesa devices, according to the researchers.

**Stripline circuitry.** Texas Instruments is also working on planar germanium transistors for computer switching. Target here is to reduce emitter width to obtain transistors with a minimum  $f_T$  of 3 Gc and a base resistance of less than 40 ohms. These would be delivered in the Microline package which is designed for stripline circuitry with 50 ohms input and output impedance. Such transistors might also be used as chip transistors in thin-film microcircuits. The available isolation would enable their high-frequency capability to be realized.

Meanwhile, Motorola, Inc., is working to develop a planar-type passivated germanium transistor. It will be made with the annular—or ring-shaped—process which Motorola says has proven effective in avoiding channeling and increasing the breakdown voltage of silicon pnp transistors.

## Electronics abroad

### Chip transistors

A new way to manufacture chip transistors will bring the price of silicon planar transistors down to that of germanium types by late 1965, according to Standard Telephones and Cables, Ltd., of Footscray, England, developers of the technique. The company is a subsidiary of the International Telephone and Telegraph Corp.

Basis of the system is a new layer structure resulting in a single-sided electrode arrangement. The emitter, collector and base electrodes all terminate on the same side of the semiconductor slice. This will eventually permit fully automatic assembly of the chip on the header. At present, it's done by hand.

The Footscray plant is concentrating on production of a specialized switching transistor housed in a TO-18 header can, but Standard Telephones plans to market a complete range of devices.

**Evolutionary approach.** Standard Telephones feels that its chip transistors will bridge the gap between the various construction techniques in use today. The chip can be used in the TO-18 header can and wired into normal circuits, it can be soldered straight onto a thin-film wafer, or it can be soldered to a substrate that interconnects a number of chips.

**Production methods.** Silicon crystals are sliced into wafers 9 mils thick. More than 500 transistors are formed on each wafer by diffusion and photolithography techniques. Grinding, usually required in manufacturing conventional planar transistors to bring the collector resistance down to a suitably low value, is unnecessary.

All areas not requiring solder connections are masked. The wafer then passes through a solder coating which places a uniform-height solder layer on the three contact areas, at each transistor base.

**Fast assembly.** The wafers are broken to form individual chip

transistors, each 0.009 by 0.04 by 0.03 inches. This makes automatic handling easier.

Individual transistors are then placed manually onto specially shaped header pins formed of three thick copper leads angled like a tripod and cut on top to form a flat surface. This reduces tolerance requirements and eliminates precision jiggling. Tolerances are increased in two ways:

- The tricky job of positioning a 1-mil thick connection wire onto a 2-mil square connection on the conventional chip is eliminated. Instead larger connection areas allow a 4-mil tolerance.

- As the wafer is heated to make the solder connections, the viscous effect of the molten solder automatically positions the chip centrally on the header wires. All three connections are made simultaneously. Test circuits built into the jig check the transistor.

Connections withstand a 175-gram pull test compared to 2 grams used in testing leads bonded by the thermocompression method.

Production rates of the switching transistors are two and a half times those of conventional transistor manufacture and the British company's engineers happily report consistent yields of around 80%.

**Consequences.** Standard Telephones believes the ability to provide silicon performance and reliability at low cost will affect equipment design.



Chip sits on tripod formed by leads.



# “Oww!” said Mblvt, hopping around on three legs and holding the fourth in his hands. Clumsy as usual, the brat had stumbled getting out of the spacescooter.

“Quiet!” I whispered sharply. “Do you want an Earther to see us like this?” I looked across from the grove of trees to the long, low building, but there was no sign that anyone had heard.

I set the scanner-synther to find and analyze some examples of the dominant Earth life-form. Then I set it to synth two individualized, self-powered, bioplastiform replicas of the adult male type, complete with concealed aerogills and appropriate clothing. They have two sexes just like us. Otherwise, their appearance and behavior is pretty weird. For instance, instead of nice, clean water, they breathe a mixture of air, smoke and fog.

Wearing the replicas, we stepped out onto the sidewalk and approached the building entrance. A sign said “Electronic Engineering Company of California.” Mblvt was having trouble controlling his replica’s two (!) legs. Why did he have to tag along, I thought, when the success of the entire invasion could depend on our getting information on the Earthers’ most advanced data-handling technology.

After dealing with a live female receptionist (they don’t have annunciators) we found ourselves talking to a personable adult male Earther.

“Where did you say you’re from?” he asked, as my autotrans unit interpreted for me.

“We’re from, uh—” My portable scanner had found the name of one of their data-handling customers in a nearby file cabinet. “—from Hughes Aircraft. We’d like to investigate buying something that accepts analog or asynchronous digital data and prepares a blocked computer tape.” As I rattled this off glibly into the autotrans I was glad I’d studied hard enough in elementary school to get a B in Comparative Infotonics.

“You couldn’t have come to a better source,”<sup>1</sup> said the Earther. “In the past few years we’ve built over forty systems of that type for agencies all over the country. We call our general system the EECO 751 Computer Format Control Buffer. Step right this way, and— Oops!”

Mblvt had stumbled again. He swung one of his replica’s arms to regain his balance and a piece of test equipment clattered

to the floor. From across the room an older man, probably some kind of supervisor, gave us a sharp look. For some reason I didn’t understand our guide seemed to be trying to smell Mblvt’s Earther-replica’s breath. Of course there wasn’t any to smell, and the Earther looked puzzled.

“Here’s a unit in final checkout,” he said, gesturing toward an Earther-high cabinet. “The 751 can take data from many analog sources such as transducers or analog mag tape. Or from digital sources such as A-to-D converters, PCM telemetry decommutators and so on. And can put either kind into IBM-compatible tape. It’s available with many options, depending on what you need.”<sup>2</sup>

“How convenient,” I said politely. “Another thing,” he went on. “Did you people ever have the experience of noodling around with this kind of equipment for weeks after delivery, before you could get it to produce acceptable tapes?”

“Uh, yes,” I said at random. Out of the corner of my visual input I noticed the older Earther beckoning.

“Thanks to our experience with just about every kind of digital computer,” our Earther said, “we know their characteristics inside and out. So we can usually have the customer’s computer accepting tapes from a 751 within a matter of hours after we set the unit down on his floor. And the price! That’s the big surprise. *Starts at forty K.*”

I was surprised, all right. I’d been told their unit of exchange was the “dollar.”

“Say, would you excuse me for just a moment?” He walked over to the supervisor type. They were out of normal earshot. I readjusted for tight directional input and turned up the gain.

“—know everybody in those sections at Hughes,”<sup>3</sup> the older Earther was saying. “We recently delivered a 751 to their Culver City plant. Neither of these two characters looks familiar.”

“You don’t suppose they’re spies from the competish?” the younger one suggested. “Trying to get the scoop on our latest products?”

My autotrans drew a blank on the word “competish.” I scanned frantically among the EECO filing cabinets for a “Competish Company.” Or an enemy nation. Nothing.

“That must be it,” the older Earther said. “I’m surprised they’d send a heavy drinker on that kind of errand.”

Heavy drinker! Suddenly it dawned on me what “Competish” must be their word for.

“Mblvt!” I hissed. “They’re wise to us! They know we’re from the Deuterium Planet! Let’s get out of here! This may cancel the entire plan to invade Earth!” We made a dash for the door.

Moments later we lifted off in the spacescooter. I turned on the turbuloseen so if any Earthers happened to be watching we would merely look like a medium-sized dust-devil as we ascended.

At 187,000 feet altitude a familiar voice blasted into my input, “Tgpdk! Where have you been?” It was Pa.

“Your mother and I have been frantic!” he scolded, sucking the spacescooter through the in-hatch of our spacehouse. “Have you been down there playing Invasion again?”

I hung my head guiltily.

“You know how we disapprove of that silly, anachronistic game! And letting your baby brother come along! Why, he’s hardly old enough to know how to walk! I thought you had more sense!”

“I’m sorry, Pa,” I said. But I wasn’t. Those EECO guys had been real neat fun to talk to.<sup>4</sup>



<sup>1</sup> In addition to being a leading supplier of data-handling equipment, EECO is the nation’s most experienced developer of time-code equipment. And our other division, Engineered Electronics Co., is the standard producer of plug-in circuits.

<sup>2</sup> Other features: Automatic tape advance to load point. Parity and self-check. Digital data input: 48 parallel bits. And the 751 will accept a time-correlation signal and record it on the blocked output tape without losing any of the real-time data.

<sup>3</sup> Other EECO 751 users: National Bureau of Standards, NASA, U.S. Air Force, Lockheed Missile & Space Co., Space & Information Division of NAA, Signal Corps, IIT Laboratories, GE, Douglas, Army Ballistics Research, many others.

<sup>4</sup> Real neat help, too, if you have a data-handling problem. SEND FOR FULL PROCUREMENT SPECS on the 751. Address: Electronic Engineering Co. of California, Mail Station 1630, Box 58, Santa Ana, California. EE 4-3



# Business Aid To Education: Let's Broaden The Base

The total amount of financial support that American business corporations are giving to our colleges and universities is increasing rather impressively. But the number of companies contributing to this expansion is woefully small. If business support of higher education is to attain the proportions it clearly should attain, there must be a large increase in the number of companies participating — and soon.

The Council for Financial Aid to Education estimates that business firms contributed about \$200 million to education in 1962. This was up from a total of about \$178 million in 1960; and preliminary indications are that business-giving will exceed \$200 million this year. As a total, this is a relatively impressive figure. It becomes more impressive when viewed against the fact that it will be about two and one half times as much as business firms were giving to education ten years ago.

## A Flaw In The Picture

But there is a grave flaw in this picture of business-giving to higher education. The giving is concentrated in relatively few business firms that provide large sums, while hundreds of thousands of firms do little or nothing at all. Of the \$200 million contributed to education by business in 1962, the Council for Financial Aid to Education found that about \$70 million, or more than a third of the total, came from only 150 companies, each of which contributed more than \$100,000. In fact, increased giving by large corporate contributors accounted for most of the total increase in corporate giving between 1960 and 1962.

There are no figures comprehensive enough to determine precisely how many business firms contribute to the support of higher education in the United States. But studies indicate that virtually all of this aid comes from less than one per cent of U.S. business establishments.

## Unused Capacity For Business Giving

At the present time, there are more than four and three quarters million business establishments in the U.S. A great many of them, of course, are one-man establishments which are not able to help higher education financially. But there are tens of thousands of others which have unused capacity to help.

Inquiries by the Council for Financial Aid to Education indicate that almost half of the nation's 500 largest industrial corporations have no programs to help our colleges and universities financially. With combined profits after taxes of almost \$2 billion in 1961, these firms represent an imposing, untapped potential for help. And so do tens of thousands of smaller companies. Their gifts would be smaller, but their numbers would compensate for necessarily smaller amounts by coming in much larger numbers.

The Council for Financial Aid to Education has set a goal of \$500 million for annual corporate aid to our colleges and universities by 1970. Very conservatively estimated, the total expenditure for higher education at that time promises to be \$9 billion to \$11 billion a year. This makes \$500 million a relatively modest share in the support of educational operations so vital to the welfare of the nation and the business community.

### Needed— A Much Broader Base

But if this goal is to be reached, the base of corporate support must be broadened. This means more and more effective work by the colleges and universities in seeking support from smaller companies. It means more readiness by more firms to listen with understanding and sympathy, and then to use their capacity to give financial support accordingly.

Viewed narrowly, it is in the selfish interest of business firms to help our colleges and universities financially. By doing so, they give essential

support to basic research, centered in the universities, upon which the business system depends heavily for the opening of new scientific frontiers. Financial support for higher education also helps to insure a continuing supply of well trained graduates which business firms must have to insure their own continuing success.

By making it tax exempt, the federal government, in effect, assumes half of the cost of financial aid for higher education by business. But this fiscal fact does not detract from both gratitude and respect which business firms can win for themselves by providing such aid. And in the last analysis, if financial aid is not provided voluntarily, it can confidently be expected that business will ultimately provide much of it involuntarily, through taxation.

Viewed in terms of the broad public interest, the business community has an opportunity to play a key role in providing our colleges and universities with the financial strength essential to assurance of their successful development which, in turn, is basic to the success of the nation.

**There are few, if any, financial operations that can pay larger returns in advancing the national interest, as well as the more immediate interest of the business community, than that of seeing our colleges and universities receive steadily increasing financial support from more and more business firms.**

This message was prepared by my staff associates as part of our company-wide effort to report on major new developments in American business and industry. Permission is freely extended to newspapers, groups or individuals to quote or reprint all or part of the text.

*Donald McGraw*

PRESIDENT

McGRAW-HILL, INC.

**INTERNATIONAL RECTIFIER EXCLUSIVE:**

**GUARANTEED**

**$dv/dt$**

**200 V/ $\mu$ sec minimum**

**70 AMPERE EPITAXIAL CONTROLLED RECTIFIER**

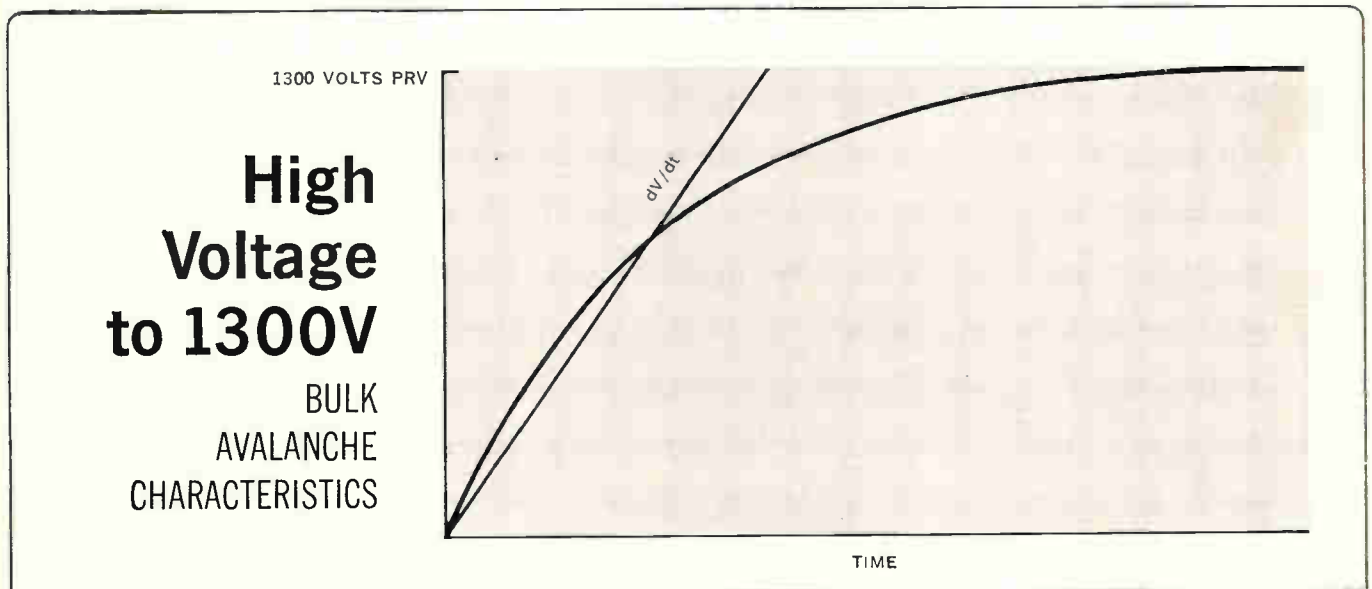

*EXCLUSIVE  
WITH  
INTERNATIONAL  
RECTIFIER:*

- Minimum critical rate of rise of forward voltage ( $dv/dt$ ) of 200 volts per microsecond
  - Bulk avalanche characteristics to 1500 volts
  - Positive temperature coefficient of blocking voltage: 0.1% per °C
  - Rated at 600 to 1300 volts PRV; 110 amperes RMS
  - Devices are designated 71REB60 through 130 (dual control leads) and 72REB60 through 130 (flag terminal types)
  - Eliminates complicated, bulky and expensive filtering circuits
  - Designed for direct application on industrial power lines up to 480 volts
- For further information request Bulletin SR-452-X



**INTERNATIONAL RECTIFIER**

INTERNATIONAL RECTIFIER CORP., EL SEGUNDO, CALIF., PHONE OR 8-6281 • CABLE RECTUSA • REGIONAL OFFICES IN NEW YORK CITY, CH 4-0748 • FORT LEE, N.J., WI 7-3311 • SYRACUSE, N.Y. HE 7-8495 • CAMBRIDGE, MASS., UN 4-6520 • AROMORE, PA., MI 9-3667, GR 3-3932 • SILVER SPRING, MD., JU 9-3305 • MIAMI, FLA., 445-5201 • CHICAGO, ILL., OR 6-4090 • CLEVELAND, OHIO, 734-4100 • DAYTON, OHIO, 223-7691 • HUNTINGTON WOODS, MICH., LI 8-1144 • ST. LOUIS, MO., TE 8-6333 • MINNEAPOLIS, MINN., 920-1200 • OALLAS, TEX., 3511 HALL ST., LA 1-0110 • LOS ANGELES, CALIF., OR 8-6281 • IN CANADA: TORONTO, ONT., PL 9-7581 • MONTREAL, QUE., VI 9-3571

---

# Washington Newsletter

---

June 1, 1964

## **New stress seen on civilian R&D**

In the next few months, a new species of requests for proposals may point the way to one avenue of conversion of defense-oriented skills to civilian uses.

The new requests may solicit proposals in medical electronics, urban transportation or water purification. Best guess is that the first request will involve the National Institutes of Health. The Department of Health, Education and Welfare and the Bureau of Public Roads are other likely participants.

According to Arthur Barber, deputy assistant secretary of defense, the defense budget probably will continue to decline for five years. He adds that President Johnson has said he will not run a "WPA" defense program.

However, Barber says, there is a great deal of interest in civilian projects. According to Barber, "Washington is waiting to hear proposals" for programs in the public interest, particularly in health, education, medical care, the war on poverty, unemployment and retraining brought on by automation, and in urban transportation. "There is more money being spent today on laser R&D than on transportation R&D," despite the seriousness of the transportation problem, Barber laments.

Barber warns electronics companies not to base marketing plans on such things as a giant military communications satellite program, which he says is not in the cards in the foreseeable future, nor on what he describes as a "mythical" \$200 million program for arms-control monitoring systems.

He says too many marketing plans revolve around solutions looking for problems. "Drop the solutions and go out and find realistic problems that are looking for economically feasible solutions," he urges. Barber concedes that the government is not organized effectively to bring R&D and innovation to bear upon existing nondefense problems. But, he says, work in that direction is intensifying.

## **Electronics' stake in mass-transit bill**

Makers of electronic controls have a big stake in the mass-transit legislation before the House of Representatives. The vote on the three-year, \$500 million program is expected to be close. If it passes, the only remaining hurdle will be adjustment of differences with the versions already passed by the Senate.

The bill calls for government assistance to speed construction of new rail transit systems or modernization of existing systems in such cities as New York, Boston, Philadelphia, Chicago, San Francisco, Los Angeles, Atlanta, Washington and Cleveland. The systems would make extensive use of automation—computer traffic control, automatic routing systems, crewless cars, systems to avoid collisions, automatic fare-collection, remote monitoring and display, two-way voice and data communications.

## **House unit votes college aid funds**

Congress shows signs of buying the National Science Foundation's program to build up scientific capability in colleges and universities outside the mainstream of research and development. The House Appropriations

---

# Washington Newsletter

---

Committee has voted \$25 million for the "centers of excellence" program [Electronics, Apr. 6, 1964, p. 43] for fiscal 1965. The foundation would make many grants of about \$3 million to \$5 million for faculty or facilities, to institutions that show promise of being able to beef up science curriculums.

The committee's attitude represents a shift from last year, when it slashed the foundation's funds drastically. The foundation squeezed \$3 million out of the current budget to start the centers-of-excellence program, though it hasn't yet made any grants. It expects the program to grow to \$60 million to \$70 million a year in the next 10 years.

## U. S. also uses electronic spies

Recent discoveries of 40 microphones embedded in the walls of the United States Embassy in Moscow provide fresh evidence of the heavy reliance the Russians place on electronic gadgetry for spying. But American use of electronic equipment for the same purpose will soon be getting public attention, too. An already controversial book soon to be published will delve into the electronic spy operations of the Central Intelligence Agency and the National Security Agency of the Defense Department: "The Invisible Government," by David Wise and Thomas Ross, is already causing consternation among some government officials who would prefer to maintain the level of secrecy that now covers the two agencies.

## Pentagon weighs R&D pay policy

The Department of Defense is having trouble working out a policy on reimbursing contractors for the costs of R&D that leads to an item that proves to have military value. With Pentagon-initiated contracts falling off, small electronics firms are anxious to proceed independently in military R&D if the Pentagon will allow some of the cost in contracts it does award. The Pentagon and the Defense Industry Advisory Council agree on the need for a formal policy, but there are differences on specifics. A high-level committee of the council and defense officials has been set up to study the problem.

## Rules on rights to technical data

Pentagon regulations giving the government broader rights to technical data under military contracts have been put into effect on an optional basis, and will become mandatory on Oct. 1. But field experience with the regulations, detailed in defense procurement circular No. 6, may lead to changes before October.

The biggest change eliminates the concept of proprietary data, which appears in present regulations and has been a continuous source of controversy. Present rules prevent the government from obtaining proprietary data on any basis in certain circumstances.

## Further favor for smaller firms?

A Small Business Administration official has come up with an idea for coping with the drop in military contracts. Irving Maness, the agency's deputy administrator for procurement, would like to shift as much of the burden as possible to the major defense contractors by increasing the emphasis on awarding defense contracts to smaller firms.

Maness is still pushing his idea within the SBA. Any such proposal would almost certainly stir up controversy in Congress.

# How Potter & Brumfield precision-cleans missile relays for top reliability!

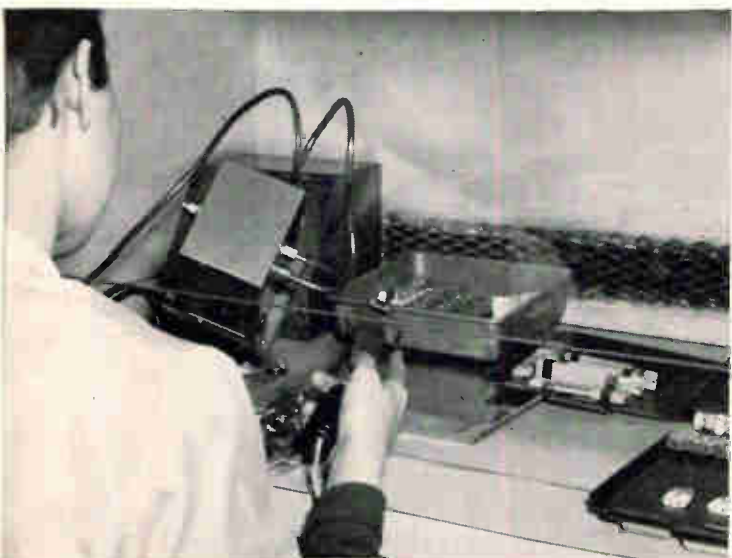
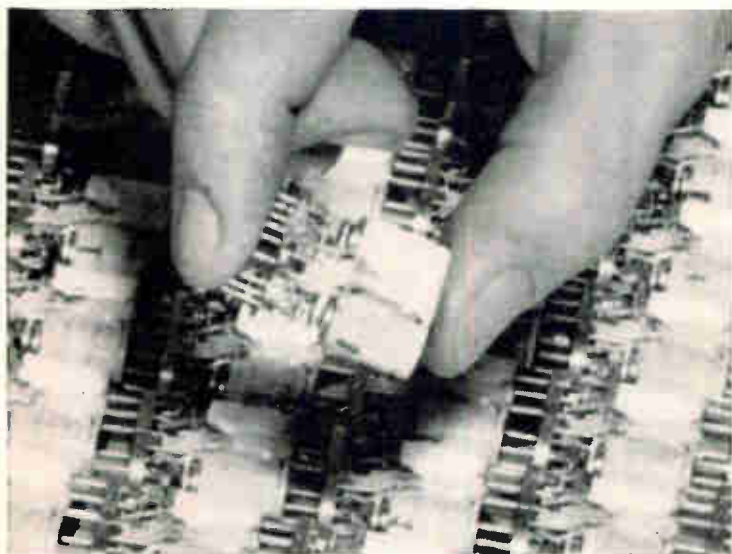

**PROBLEM:** How to reduce an unacceptably high reject rate on critical "crystal-case" electrical relays (first photo) at Potter & Brumfield, Division of American Machine & Foundry Company... eliminate employee problems of headaches and nausea due to solvent vapors.

**SOLUTION:** A new cleaning system using "Freon" fluorinated solvents. "Freon" is an excellent selective cleaning agent. It removes solder flux, dust, lint and other contaminants, yet doesn't harm delicate relay parts. Also, "Freon" is virtually non-toxic, thus eliminating complaints about vapors.

In the cleaning process, a basket of relays is first given a 15-second ultrasonic bath in "Freon" TMC, then an ultrasonic bath in "Freon" TF for 15 seconds (second photo), and a 15-second rinse in TF vapor. Because of its low surface tension, "Freon" quickly penetrates the tiny spaces in the relays, allowing precision cleaning of delicate parts.

As a final cleaning step, the relay contacts are washed in a spray of "Freon" TF, while being electrically actuated (third photo). This assures that no particles are entrapped between the contacts. Only the high dielectric strength of "Freon" makes this operation possible.

According to Potter & Brumfield, the adoption of "Freon" solvent cleaning has upgraded product quality, meeting their critically high standards, equivalent to a 17% increase in production capacity while at the same time decreasing labor costs. They point out that "Freon" dries quickly and leaves no residue, and that its non-flammability and low toxicity let them operate without expensive ventilating equipment. They've found "Freon" solvents economical to use because they can be recovered in simple equipment for reuse... over and over again. Most important, "Freon" solvents have eliminated employee complaints on nausea and headaches.

• • • • •  
We'll be glad to give you help in selecting "Freon" solvents for use in your own cleaning operation. Just write on your letterhead to Du Pont, 2420E-6R Nemours Bldg., Wilmington 98, Delaware.

**FREON**<sup>®</sup>  
solvents



BETTER THINGS FOR BETTER LIVING . . . THROUGH CHEMISTRY

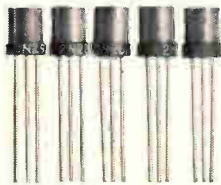

## These silicon planar transistors are under a quarter\*

### AMPLIFIER APPLICATIONS

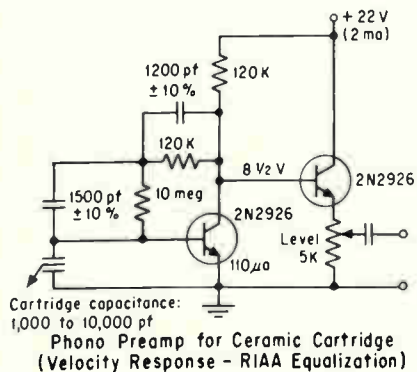

### SWITCHING APPLICATIONS

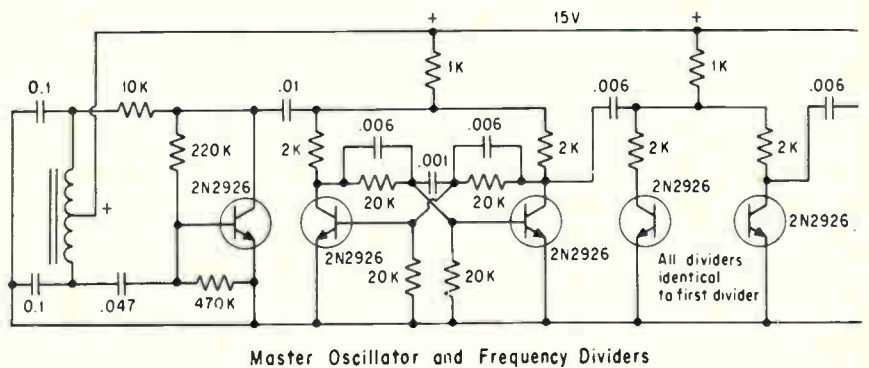

## Type 2N2926 offers 2 to 1 beta spread, tight parameter control, high reliability

The new G-E 2N2926 is a planar passivated, high performance, high value silicon transistor made possible by advanced manufacturing techniques, highly reliable encapsulation, and utilization of the full-line distribution of  $h_{fe}$ .

The 2N2926 is a type provided in 5 beta categories, each with a 2-1 beta spread. Each beta category is color coded, and the per cent of the total order shipped in each category is set.

The 2N2926 is only one of the growing number of types in our "Economy Line" of transistors. Millions of units in use in the field for over two years have proven them rugged and reliable. They are probably the toughest transistors made today. Used in proximity fuses for artillery shells they have actually withstood 90,000 Gs linear acceleration!

Find out how you can enjoy high performance with real savings by designing equipment utilizing all 2N2926 beta categories in proportions compatible with this "full line distribution" type. See your General Electric District Sales Manager, or write Section 16F166, Semiconductor Products Department, General Electric Company, Electronics Park, Syracuse, New York. In Canada: Canadian General Electric,

189 Dufferin Street, Toronto, Ont. Export: International General Electric, 159 Madison Avenue, New York, 16 N. Y.

\*Suggested resale price per unit (shown actual size).

### 2N2926 ABSOLUTE MAXIMUM RATINGS (25°C)

Voltages			
Collector to Emitter	$V_{CE0}$	18	V
Emitter to Base	$V_{EB0}$	5	V
Collector to Base	$V_{CB0}$	18	V
Current			
Collector (Steady State)*	$I_C$	100	ma
Dissipation			
Total Power (Free air at 25°C)**	$P_T$	200	mw
Total Power (Free air at 55°C)**	$P_T$	120	mw
Temperature			
Storage	$T_{STG}$	-30 to +125°C	
Operating	$T_J$	+100°C	

\*Determined from power limitations due to saturation voltage at this current.

\*\*Derate 2.67 mw/°C increase in ambient temperature above 25°C.

Available through your G-E semiconductor distributor.

**GENERAL ELECTRIC**



# Electronics technical articles

---

## Highlights

---



**The case for magnetic logic: page 40**

Magnetic elements make reliable circuits for military and industrial applications, as well as serving as memory storage. This tutorial article describes the advantages of magnetic elements, examines some materials, and tells how magnetic elements can be used in a variety of circuits.

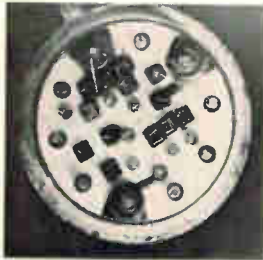

**How to design micropower amplifiers: page 48**

The need for micropower circuits extends past space applications into medical electronics and some consumer applications. In part two of this series, the authors describe some high performance amplifiers. A cascode design is particularly attractive because it supplies significantly larger bandwidths.



**Testing transistors in circuit: page 53**

Since leakage current is an accurate and reliable indicator of a transistor's quality, a method of spotting excessive leakage is desirable. An in-circuit tester checks leakage by measuring collector current when collector and emitter junctions are reverse-biased.



**Better styling by machine: page 64**

A computer program turns out perspective designs showing, for example, how an auto looks from any direction. One big problem is obtaining input data, which has been gathered there on a new machine by using a laser beam.

---

## Coming June 15

---

**Designing around second breakdown in transistors**

**Component performance at temperature extremes**

**Electronics guides an underwater killer**

**Solid state modernizes old-fashioned boiler controls**

**A new way to photoetch thin-film components**

# The case for magnetic logic

Magnetic elements, long used in storage applications, perform boolean logic and other digital tasks. With magnetic logic, radiation-resistant computer circuits are possible

By John Rogers and John King

Information and Communications Division,  
Sperry Gyroscope Co., Division of Sperry Rand Corp., Great Neck, N.Y.

**Magnetic memory devices** are firmly entrenched in digital computer technology. Commercial and military computers alike depend on them for reliable, fast-access storage at relatively low cost. Advances in circuit and logic technique have increased interest in magnetic circuits for logic applications.

Magnetic elements are capable of performing such digital tasks as boolean logic, counting, arithmetic operations, decoding, and memory addressing but none of these logic capabilities has been exploited as fully as the storage application.

The magnetic elements used in digital applications are characterized by exceptionally high residual magnetism. The hysteresis loops for such elements are referred to as square loops. This strong hysteresis effect is illustrated by the idealized square loop shown in A, page 41. Note that with zero-applied magnetizing force ( $H$ ), the core will retain a residual flux of either  $+B$  or  $-B$ .

A magnetic core is inherently a two-stage device. In a non-energized state, the flux internal to the core will be either in a clockwise or a counterclockwise direction. As commonly used in digital applications there is no middle, or half-energized state. Referring again to the figure; it can be seen that a magnetic core is also a threshold device. To switch a core from one of its two possible states to the opposite state, the driving magnetomotive force (mmf) must be of the proper polarity and of greater value than the threshold of the material. The threshold mmf required to switch a given material is defined as the coercive force of the material.

The magnetic core is in fact a flip-flop, capable of storing a binary bit. An input magnetizing force can switch it to a one or a zero state. After the input stimulus is removed, the core will remain in the state to which it was switched. The magnetic

flip-flop differs from the transistor or vacuum-tube flip-flop in that it is dynamic in nature. In the conventional flip-flop, a steady-state voltage exists which indicates the state of the flip-flop. The state of a magnetic core cannot be measured as an electrical signal without disturbing stored information. To measure the contents of a core that has been set to the one state, the core is switched to zero and a voltage is measured on a sense line threading the core. At the end of the reading operation the core is in the zero state. The information stored in the core has been destroyed. Although multiaperture cores have been devised to prevent the loss of information in the reading process, even in multiaperture cores no steady-state indication exists. The readout process disturbs the state of the element and usually the element has to be reset before it can be read again.

## Advantages of magnetics

A principal advantage of magnetic elements is their inherent reliability. Since they are made from a homogeneous magnetic material, none of the common mechanisms of failure normally found in electronic devices is present. The devices are completely passive in nature and their prime failure modes are mechanical. Most failures can be attributed to rough handling or poor quality control in manufacturing. Deterioration with life does not appear to be a factor contributing to magnetic-core failures.

Experience has shown that, in addition to the element's basic reliability, a circuit using magnetic logic requires a smaller total number of components than an equivalent circuit using conventional semiconductors, thus further increasing reliability.

Low cost is another advantage of magnetic materials. Ferrite cores in quantity cost about 10 cents each. Tape-wound cores cost less than one

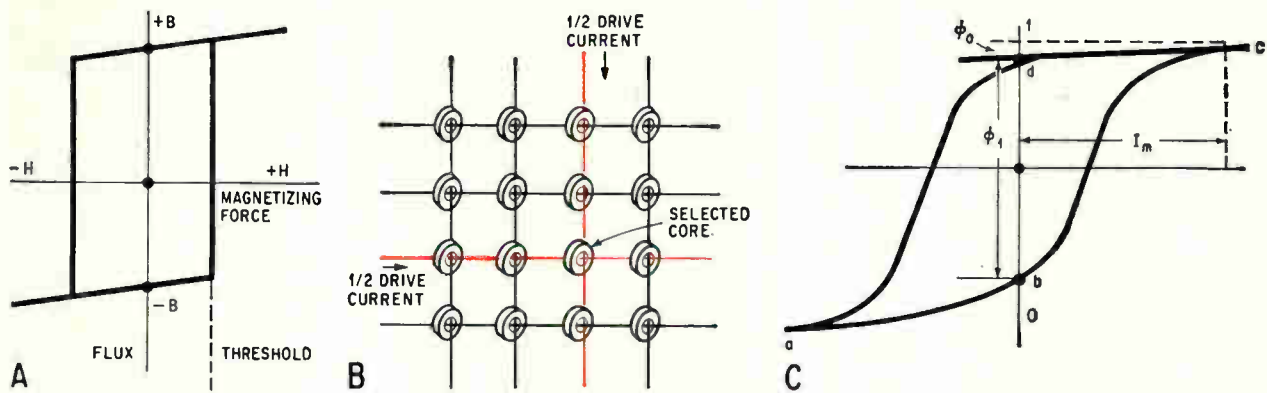

Idealized hysteresis loop for square-loop magnetic cores (A); core array selected by coincidence current (B); non-square hysteresis loop for magnetic materials (C)

dollar each. However, in constructing memories, the major cost is not in the elements, but in the cost of wiring them into matrices. Logic units, in general, use fewer elements than memories, and their assembly cost is competitive with conventional semiconductor assemblies.

In some areas, magnetics are vastly superior to semiconductors. For instance, magnetic elements have an inherent resistance to nuclear radiation. Resistance both to pulses of gamma rays and to steady-state neutrons is several orders of magnitude better than can be achieved with semiconductors.

High temperature is another area where magnetic logic can outperform semiconductors. Under a program sponsored by the Research and Technology division of the Air Force, the Sperry Gyroscope Co. has demonstrated a magnetic logic circuit which operated successfully at 400°C, whereas the absolute limit for standard silicon semiconductors is about 175°C. The results to date indicate that magnetic circuits can be built to operate at temperatures in excess of 500°C.

### Difficulties in applying magnetic logic

Most of the difficulties in successfully applying magnetics are related to the degree to which the hysteresis loop remains square over the desired range of operating temperature. A technique used in memories for selecting a particular core from an array of cores is the X-Y, or coincident-current, addressing technique. Using this technique, the number of drivers required is proportional to the square root of the number of words in the memory. In large memories, coincident-current addressing helps keep the required number of memory drivers within reasonable bounds.

The coincident-current or half-select approach depends on the threshold characteristics of the element. A core is selected by sending half the current required to select it along one wire. The other half of the required current is sent along a second wire at right angles to the first, as illustrated in B above. Note that many unselected cores receive half the current or are "half-disturbed." Obviously, extensive changes in the

coercive force of the magnetic material and consequently in the amount of current required to switch the element will cause the coincident-current approach to fail. Also, non-square-loop cores such as illustrated in C above will generate high shuttle voltages and thus produce a "noisy" system. The widely used Permalloy tape core exhibits these non square-loop characteristics.

Changes in coercive force are by far the worst problem. If the coercive force is too high, the selected core will not switch; if the coercive force is too low, the half-disturbed cores will begin to switch.

The coercive force of standard ferrite material varies greatly with temperature (typically one to two percent per degree C). Thus the coincident-current approach to selection severely limits the temperature range when standard ferrite cores are used.

Permalloy material has the lowest drive characteristics of any standard metallic tape but it is not nearly as "square" as the ferrite type material. Therefore, in coincident-current schemes its operation can be characterized as marginal.

Many of the commonly held ideas on the basic limitations of magnetic elements are derived from the limitations of the coincident-current approach. However, it is not necessary in constructing a magnetic logic concept to rely upon coincident-current principles. Various techniques that avoid this pitfall will be discussed. All feature magnetic circuitry capable of wide temperature operation and operation virtually independent of changes in coercive force.

### Properties of specific materials

Tape-wound cores (Permalloy) have relatively low current drive requirements and excellent temperature stability, while ferrite cores have a more square hysteresis loop. While tape-wound cores are used for steering and current control, the ferrites are more suitable for memory and register applications. Tape-wound cores can, however, be used to great advantage in fixed-program memories.

In general, ferrites exhibit a much better squareness ratio than tape-wound cores. However, their

switching times and coercive force are much more temperature sensitive. To operate over a wide temperature range ( $-55^{\circ}\text{C}$  to  $125^{\circ}\text{C}$ ) coincident-current techniques cannot be used, except as described below. The use of ferrites is possible, however, over the above range by proper logic design and the use of multiaperture magnetic elements. A basic test pattern similar to the one used for tape-wound cores may also be used to test ferrite cores. The ferrites are pressed from powder with precision steel dies and are much cheaper and smaller than tape-wound cores. Automatic techniques for fabrication and test make these elements attractive as to cost. Newer lithium ferrites require higher drive currents, but permit coincident-current operation over much wider temperature ranges ( $100^{\circ}\text{C}$  spread).

### Logic concepts

As implied, dependency upon threshold can restrict temperature range, place severe requirements on drive currents, tighten core specifications, increase test time, and in general make the design costly and possibly marginal.

Magnetic inhibit logic is one approach that successfully avoids dependence on the threshold characteristics of the magnetic elements. As the name implies, currents are used to inhibit the switching of magnetic elements when system logic indicates. The principles can be illustrated by referring to the figure opposite that shows a magnetic core and its hysteresis loop. Four wires are shown linking the core: a read, write, inhibit, and sense wire; the last wire is used to sense the output of the core. The polarity of the read pulse is such that it will switch the core from the one state to the zero state. The write pulse can switch the core from the zero state to the one state. Thus, a two-cycle timing system is established consisting of successive write and read pulses.

Conditions of operation are as follows: a read current is present in the core every read time. A write current is present in the core every write

time. These two current pulses constitute the system clock. The write pulse will always write a one into the core unless it is prevented from doing so by the simultaneous presence of an inhibit current, which is of opposite polarity and equal or greater in magnitude than the write pulse.

The inhibit wire is the means by which logic is performed. It can be energized only during write-pulse time. If a zero is to be written into the core during a particular write time, the inhibit line is energized. If a one is to be written, no current flows on the inhibit line.

Additionally, the inhibit line can represent the "real" or the "not" of any boolean function. Let the inhibit line represent  $\bar{A}$  (the "not" of A). If  $\bar{A}$  exists ( $A = 0$ ) a current is present on the inhibit line and a zero is written into the core (the core is held in the zero state). If A exists, no inhibit current is present on the inhibit line and a one is written into the core. In other words, the information read from the core during the next read time is equal to the function A. ( $A = 1$ , the output of the core equals 1;  $A = 0$ , the output of the core equals zero).

On the other hand, if the inhibit wire were to represent A instead of  $\bar{A}$  as above, a zero would be written into the core when  $A = 1$  and a one would be written into the core when  $A = 0$ . Therefore the output of the core would represent the inverse of the function A. This case is illustrated in the figure at far right, opposite.

Consider now the core in the figure that has two inhibit wires in it,  $\bar{A}$  and  $\bar{B}$ . A one cannot be written into this core unless no current exists on both  $\bar{A}$  and  $\bar{B}$ . This condition exists only when  $A = 1$  and  $B = 1$ . In other words the output of the core represents the AND function; that is,  $A \cdot B$ .

The OR function is also illustrated in the figure. Two cores share the same sense wire, one core has the  $\bar{A}$  inhibit wire, the other the  $\bar{B}$  inhibit wire. A one will be read on the sense wire when  $A = 1$  or when  $B = 1$ .

---

### Radiation-resistant computer circuits

Until now, magnetic logic has been mainly serial; parallel circuits have also been successfully used. In the development of a radiation-resistant computer, Sperry has evolved a computer logic design that is parallel in nature. An adder circuit illustrating the principles has been built and demonstrated and an add time of 18 microseconds has been achieved.

The circuits developed for the radiation-resistant program use either ceramic vacuum tubes, or TIMM elements (Thermionic Integrated Micro Modules, a trade name of General Electric) as the active components. However, the design is not limited to thermionic devices. In fact, semiconductors would be more compatible with the logic approach. The logic study produced a design for a parallel magnetic computer with an 18-microsecond add time, a 198-microsecond multiply time and a microprogram control unit. Although magnetics are

considerably slower than semiconductors on a component basis, this logic organization provides a computer design with a computational capacity comparable to that of most airborne general-purpose computers currently in development.

#### Steady state

In addition to the basic reliability improvement with use of magnetics (requiring fewer active devices) another advantage, may be obtained: radiation resistance of basic magnetic elements.

Semiconductors (including micrologic) have a top exposure limit of  $10^{18}$  to  $10^{19}$  nv.t. Although use of magnetics reduces the number of semiconductors in a computer, this is not a solution to high radiation exposure, since the failure of a single semiconductor in a magnetic computer can be just as serious as in an all-semiconductor computer. The only feasible answer to operating above the  $10^{15}$  to  $10^{16}$  nv.t level appears to be

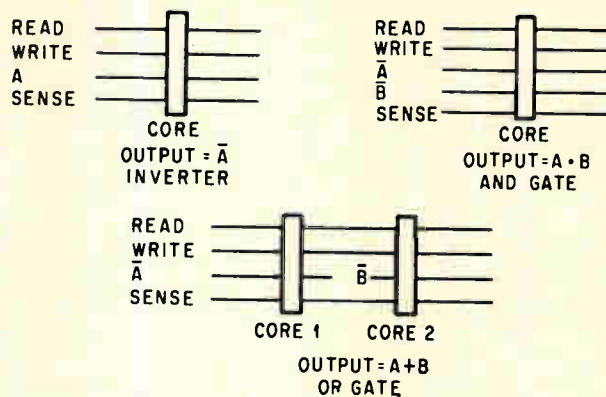
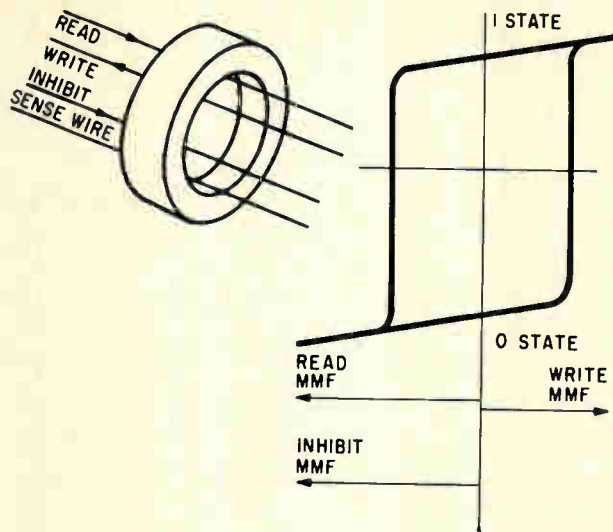

Three basic logic functions

**Basic inhibit logic concept**

Since magnetic inhibit logic is capable of performing the three functions of inversion, AND and OR, it is capable of solving any boolean logic expression.

The important aspect of inhibit logic is that the circuit operation is virtually independent of variations in the hysteresis loop. Drive currents need only be made large enough to switch the worst-case situation (usually established by the lowest operating temperature.) The inhibit current need only be large enough to cancel the effect of the write current; it can be arbitrarily larger than the required minimum without affecting circuit operation. Many inhibit lines can be strung through a single core to solve multiple-input AND functions.

**Four-phase inhibit logic**

Four-phase inhibit logic is an extension of the inhibit principles. This technique was first postulated by L. Andrews.<sup>1</sup> Later under the Air Force sponsored program the capabilities of four-phase inhibit logic were expanded, and formed the basis for the Sperry Magloc computer.<sup>2</sup>

Four-phase inhibit logic minimizes the number

of semiconductors required in a logic unit, by time-sharing a single amplifier and inhibit-current generator with every stage of a binary register. Logic is implemented by inhibit logic of the type described. Because each register stage is operated on in sequence, only one set of logic cores is required.

A typical register logic combination, as first postulated by Andrews, is shown on the next page. Each register stage consists of a single magnetic core. The time-shared electronics is called a transfer circuit. The two functions of this transfer circuit are:

1. To amplify the output voltages from both the register and logic elements during read-pulse time.
2. To generate a pulse of current during the write time on one of the two transfer circuit output lines. One output is the "real" output, the other is the "not" output. If a one was sensed by the transfer circuit during the previous read time the real output of the transfer circuit is energized. If no voltage was sensed (zero) during the previous read time the not output is energized.

To operate on a single register stage, the stage

the marriage of thermionics and magnetics. The reduction in the number of active components due to using a magnetic computer makes such a design practical from a reliability and power viewpoint. It is felt that computers employing ceramic vacuum tubes, 50-50 MiFe and ferrites can be built to operate to  $10^{16}$  n.v.t and perhaps higher. Permalloy circuits have been successfully tested to  $3 \times 10^{16}$  and probably would be usable to  $1 \times 10^{17}$ . Investigations are now in progress to develop higher temperature and higher radiation-resistant circuitry. Various magnetic materials are under investigation and magnetic portions of circuits have been operated to 400°C. This work is also sponsored by the Research and Technology division of the Air Force.

**Pulse effects**

Nuclear explosions generate both neutron and gamma-pulse bursts. Beyond the range of air pressure or thermal destruction, the primary effect is transient; there

is no permanent damage to electronic equipment. In space, under vacuum conditions, it is possible to absorb a sufficient neutron dose to destroy semiconductors, whereas magnetics need not be affected. Digital equipment can suffer from the transient effect due to the destruction of essential register and memory information. This is caused primarily by transistor leakage due to the pulse burst that can turn transistors on, although logic requires that they be off during the burst.

The Sperry Co. is now working on pulse-resistant magnetic registers using drivers designed to prevent destruction of information due to leakage effects. This work is dependent on the proven steady-state resistance of magnetics and their inherent gamma-pulse resistance.

Transient effects similar to leakage exhibited by semiconductors during a pulse burst are also found in vacuum tubes. The exact cause and severity of leakage has not been determined, although research work on these effects is now in progress.

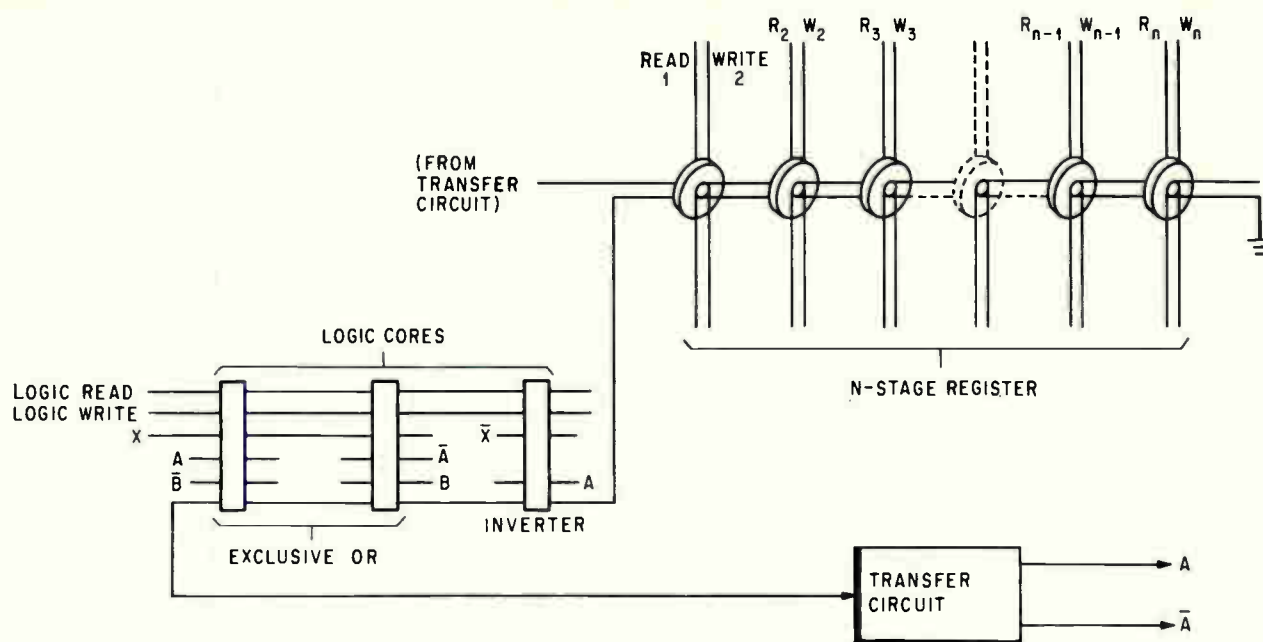

Four-phase inhibit logic register

must be read, the logic must be performed, and the results of the logic rewritten into the register stage. To accomplish this, four pulse times in the form of two read-write combinations are required. They are: 1) Read the register stage, 2) Write into the logic cores, 3) Read the logic cores, 4) Write into the register stage.

As an illustration of the applications of four-phase logic, the logic cores in the figure above are wired to perform two functions, an exclusive OR and an inversion ( $A = \bar{A}$ ).

The selection of the logic to be performed is made by the X or  $\bar{X}$  inhibit wires. Thus the X function serves as a command line to select the logic to be performed. Similarly, combinations of command lines can be used to allow the same register to perform many logic functions.

#### Areas of improvement

A closer examination of basic four-phase logic reveals apparent shortcomings. One involves the inhibit line that passes through every stage of the register. The second involves the number of current sources required for the register.

The inhibit line through every stage of the register represents a reversion to dependence upon the core's threshold characteristics. This dependence is undesirable in a magnetic-logic circuit. The inhibit current is passed through the register to prevent a one from being written into a given core. The current must be large enough to cancel the effect of the write current in the core in question. On the other hand, it must be small enough so that it is below the switching threshold of all the other cores in the register. If above this threshold, any one stored in the other register cores will be switched to the zero state. This is equivalent to the coincident-current case.

The Magloc computer avoids this problem by using two-hole ferrite elements for register stages. The two-hole element depends upon a coincidence of current for its operation. As used in Magloc, a zero is written into an element by simultaneous currents on two of the element's three legs. Neither the inhibit current alone, nor the write current alone, is sufficient to destroy information. By using a two-hole element, the virtues of inhibit logic are preserved in the register circuit. Both write currents and inhibit currents can be arbitrarily large without adversely affecting the circuit operation. A photo of the Sperry two-hole elements is shown on the cover.

#### Sources of current

The second area of apparent difficulty in four-phase logic is the number of read lines and the number of write lines required by the register. For a 24-stage register, 24 current sources are needed. Many registers can share a simple set of read and

#### A magnetic memory for the Apollo program

Magnetic cores in the inhibit mode are an excellent means for decoding N-bit binary numbers into their  $2^N$  constituent parts. Circuits of this type are called rope circuits because the physical unit resembles a rope. Memories of better than 256 words have been constructed using this technique. A rope program memory is planned for the Apollo mission.

The chief attraction of the rope circuitry is its simplicity. To decode an eight-bit word into one of 64 possible signals, an inhibit current is generated from either the "real" or the "not" side of each of the eight bits. The inhibit wires are fed into 64 cores in a pattern such that, for each eight-bit word, one unique core exists in the rope in which no inhibit current exists. A set current switches that core to the one state.

write drivers, but typical current levels are 400 ma or greater. Forty-eight current-drivers, each capable of generating a 400-ma pulse, represent a sizable investment in electronics. In fact, in most applications this kind of circuit configuration would be impractical.

Similarly, in other forms of magnetic inhibit logic, a need exists for a means of supplying current from a single source along any one of many possible paths, the choice of path depending on the logic command or upon a timing sequence set up within the unit.

This need is fulfilled by magnetic current-steering circuits. Sometimes called Karnaugh<sup>3</sup> circuits, they use the voltage generated by a switching core to back-bias diodes in all possible current paths except the selected path. Back-biasing the diodes forces all the current to be steered down the selected path. The current-steering circuits also exhibit the desirable properties of magnetic inhibit logic.

The steered current can be used as a read current, write current or inhibit current for the inhibit logic described earlier, or it can also be used to set magnetic cores in other steering circuits.

#### Basic steering circuitry

In the schematic of the simple steering circuit (above, right), say, cores A, B and C will switch in one microsecond for a current of 600 milliamperes and the output voltage is two volts per turn. The object is to steer current  $I$  down leg A through load A. Assume, before  $I$  is turned on, that core A has been set to a one by an external circuit and that cores B and C are zeros. Assume also, that  $N_1$  is six turns and  $N_2$  is five turns.

Current  $I$  is applied, its direction in winding  $N_1$  in all cores is to set the core to a zero. Core A starts switching to the zero state. Cores B and C, already at zero, do not switch. In switching core A, a voltage of  $(+5 \text{ turns} \times 2 \text{ volts/turn}) + 10 \text{ volts}$  is generated in  $N_2$  of loop  $D-N_2-E$ . Note that the voltage is in a direction that cuts off diodes  $D_C$  and  $D_B$ . As long as  $E_{N_2} - V(D_A) - V_{load} > 0$ , current  $I$  will flow down path A and be very nearly equal to  $I_m$ . The net ampere-turns on core A is  $(N_1 - N_2) 600 \text{ ma}$  or  $(6-5) 600$  or 600 milliamperere-turns. Core A will therefore switch in one microsecond and the pulse will be steered down leg A. The steer circuit can be expanded with additional paths limited only by load considerations on the source of  $I$ .

#### Tolerance considerations

It is necessary, to keep leakage current ( $I_c$ ) to a minimum, for the switching time of core A to be slightly longer than current pulse  $I$ . If the switching time of the core is shorter than the current pulse, leakage will occur on the trailing edge of the current pulse. However, if the switching time of the core is made too long, the core will not be driven to a stable zero after the current pulse, and leakage on the front end will occur during the next pulse time. Tolerance on the driving current,

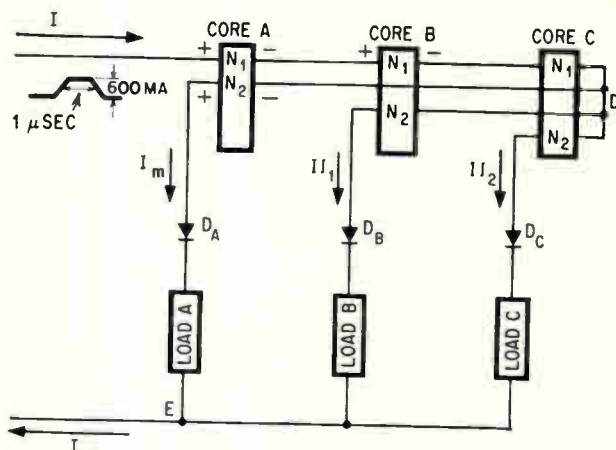

Current-steering circuit

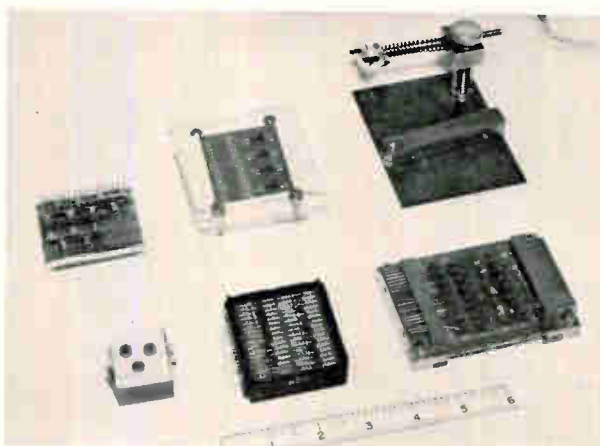

Logic circuits made with tape-wound Permalloy cores, and their assembly jigs

core switching and load characteristics must be considered. The value of leakage that can be tolerated is primarily a function of the load to be driven.

Note should be taken of the fact that although cores B and C do not switch, they still present a substantial shuttle load to the current driver. This load is proportional to the number of turns on winding  $N_1$ . Since the number of  $N_1$  turns is one more (in this case) than the number of  $N_2$  turns, minimum shuttle load is achieved with minimum  $N_2$  turns or minimum load. Computer circuits must be considered in terms of computer function, and a large problem in magnetic computers is driver loading. Unless great emphasis is placed on minimum loading, pulse delay and timing problems will surely exist. The smaller the load presented by each circuit, the larger the number of loads that can be handled by each driver. The necessity of paralleling drivers to handle additional loads should be avoided to maintain the basic advantage of low active component count. In the long run this may mean sacrificing amplitude on the output of sense voltage from the memory and register to obtain low back voltage in the drive lines. The photo shows a circuit-steering magnetic building block

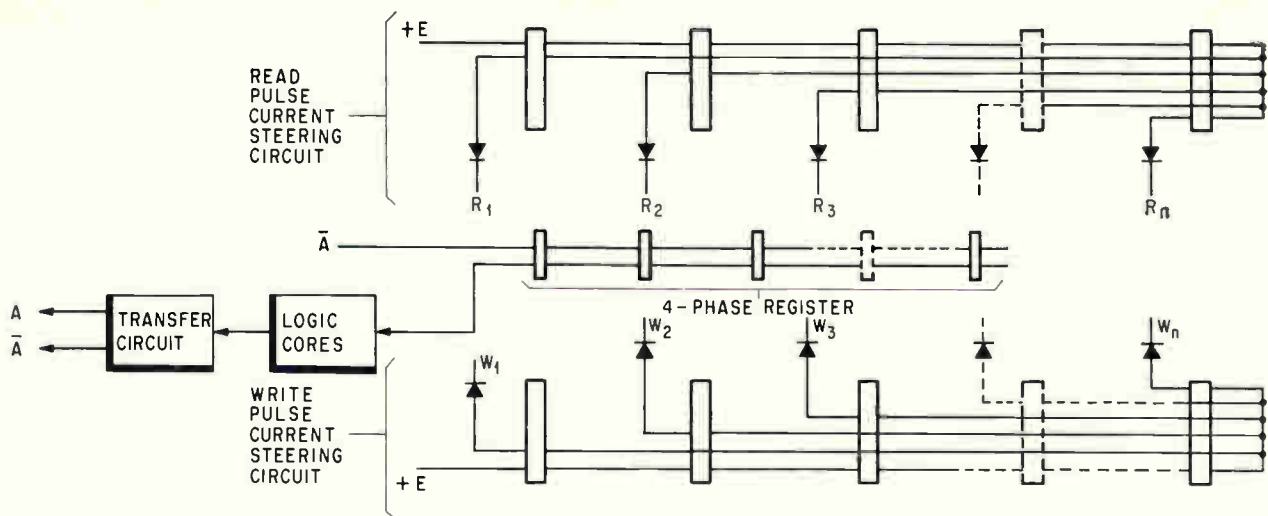

Current-steering circuits for register read-write pulses

and assembly fixture that is typical of the Magloc computer.

### Computer timing system

Consider a four-phase logic register that requires 24 read pulses and 24 write pulses in sequence.

Let one current-steering circuit supply the read pulses and a second current-steering circuit supply the write pulses as shown above.

Assume initially that core  $R_2$  is set. The driver controlling the read current is energized and the first read pulse is steered down read line 1. The steered current not only performs its function as a read pulse but it also sets a core in the current-steering circuit that supplies the write pulses. Assume it sets core  $W_1$  in the write-pulse circuit. During the first write period, core  $W_1$  will switch and steer current down write line 1. This current can in turn set the next read-pulse core. The sequence will continue:  $R_2, W_2, R_3, W_3, \dots, R_{N1}, W_{N1}, R_N, W_N$ . Thus, all the necessary read and write pulses for the register are generated in sequence by two current sources (drivers 1 and 2). The sequence is automatically repeated merely by having the last write pulse (in this case write pulse 24) set the core that controls the first read pulse.

The basic timing for the entire Magloc computer is derived from a circuit such as this, called the sequential switch.

### Sequential switch circuit

A detailed diagram of a four-stage sequential switch and its associated timing diagram are shown on opposite page. If the lower half of the schematic is removed, resemblance to the earlier basic steering circuit is evident. In this case, upper current  $PC_1$  is a series of current pulses, one for each  $C_1$  time. Lower current  $PC_4$  is a series of current pulses, one for each  $C_4$  time. The switch has a start winding (not shown), which drives core 1-1 to a one and all other cores to a zero. Before energizing the  $PC_1$  or  $PC_4$  drivers, this start winding is pulsed. Driver  $PC_1$  is then turned on and current is steered through core 1-1 represented by  $P_1C_1$ . This current sets core 1-1 to a zero and core 4-1 to a one. The  $PC_4$  driver is now turned on and current is steered through core 4-1, setting core 1-2. The action continues, with current  $P_4C_4$  setting core 1-1. Timed pulses have been generated and in turn steered through loads as desired. The switch may be extended to any number of branches, limited by loading and timing considerations. Switches of this type have been built that generate 48 current pulses (24  $C_1$  and 24  $C_4$  pulses). These pulses are basically generated with use of only two semiconductor drivers in conjunction with the low-level synchronizer generating the strings of  $C_1$  and  $C_4$  pulses. Use of this switch in conjunction with

### The authors



John M. Rogers has worked on such programs as the Sparrow missile, the B-58 jet bomber, the X-15 research vehicle, a miniature celestial inertial-navigation program, a field-artillery digital automatic computer, a nuclear detection system, and the Magloc computer.



John J. King's experience covers digital systems analysis, logic design, magnetic memory logic and component design, magnetic digital systems, computer testing, and thermionic-semiconductor-magnetic-circuit design. He has worked on the B-58 program, on digital and analog development for the AN/ALQ-27 airborne countermeasures computer, and the Magloc computer.



the register in the figure on page 44 illustrates the small number of drivers required for magnetic computers.

### Current-steering memory addressing

Magnetic circuits based on inhibit logic principles can also serve as decoding and drive matrices. A steering circuit can pick one of many lines, and could be used to drive a memory as well as to supply read and write pulses. The problem is that the number of memory drive lines to be selected is usually larger than the practical limit of the simple current-steering circuit. For instance, 64 lines is not an unusual requirement for a memory addressing circuit, but a 64-core switch from a simple driver tends to be impractical.

One novel approach to this problem is to cross-couple current-steering circuits similar to the manner in which transistor drivers and sinks are cross-coupled in more conventional memory-addressing circuits. In this approach the number of steering cores required is  $2\sqrt{N}$  if  $N$  is a power of 2.

This circuit is illustrated (below, right). Two times the square root of 16 cores are used to select one of 16 possible paths.

For any pair of selected cores, (one in the upper steering circuit, the other in the lower steering circuit) only one path has a diode that is not back-biased. In the case illustrated where cores B and G are selected, diode 7 has no back bias while diodes 3, 11, and 15 are biased by the upper core; diodes 5, 6, and 8 are back-biased by the lower core and the remaining diodes are biased by both cores.

This type of circuit has been successfully used to drive both program and data memories in the Magloc computer.

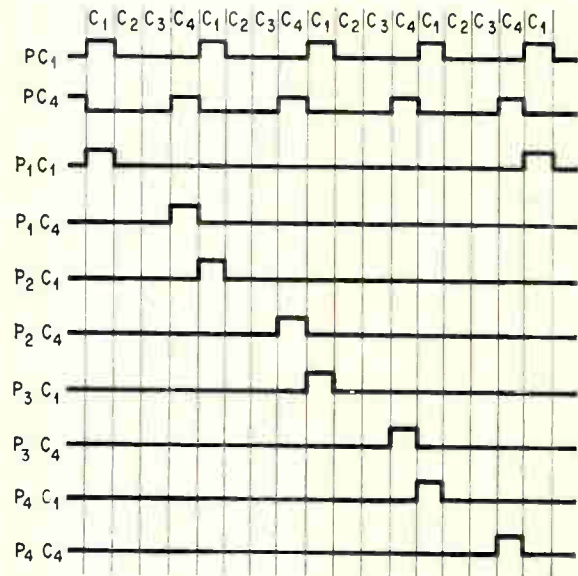
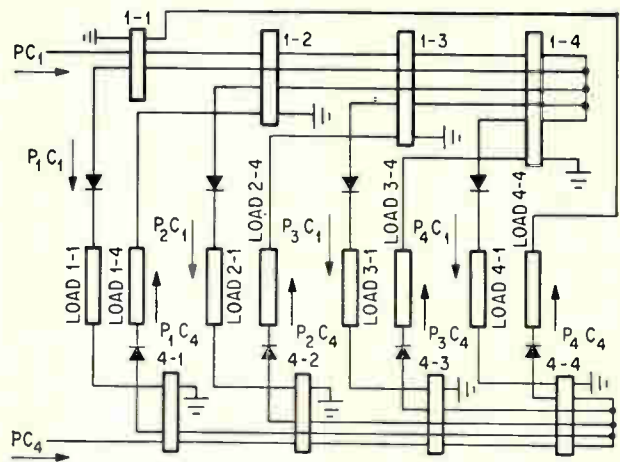

Four-stage sequential switch and timing diagram

### References

1. L.J. Andrews, A technique for using memory cores as logical elements, Proc. Eastern Joint Computer Conference p. 39-40, Dec. 1956.
2. Technical Documentary Report No. ASD-TDR-63-337, Astronavigation Computer Research, prepared for A.F. Avionics Laboratory, A.F. Systems Command, by Sperry Gyroscope Co., Division of Sperry Rand Corp.
3. M. Karnaugh, Pulse switching circuits using magnetic cores, Proc IRE, vol 43, p. 570-584, May 1955.
4. J.A. Rajchman and H.D. Crane, Current steering in magnetic circuits, IRE Trans. on Electronic Computers, Vol. EC-6, pp. 21-30, March 1957.

## Electronics

The changing form of the register, page 62  
Fast inspection with automatic control, page 79  
Confined transistorized automatics, page 87

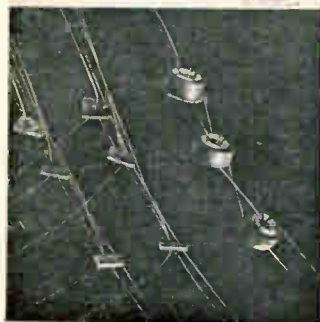

### The cover

Close-up of an all magnetic register using two-hole ferrites. Tape-wound Permalloy cores steer current. This radiation-resistant register is part of a radiation-tolerant computer for the Air Force.

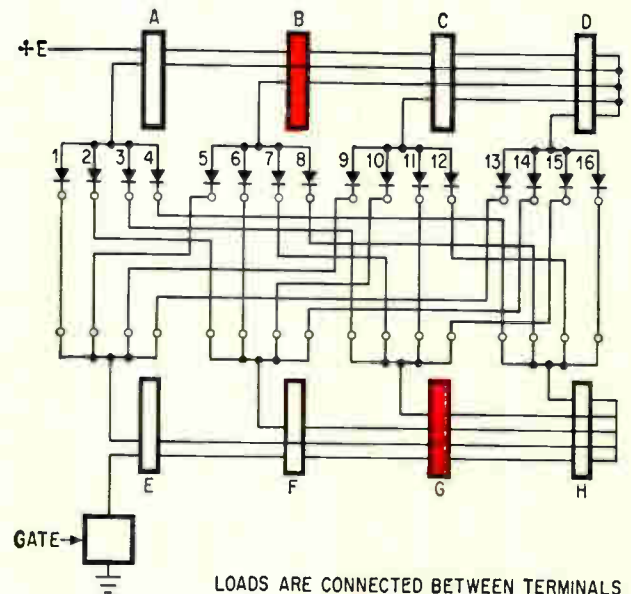

LOADS ARE CONNECTED BETWEEN TERMINALS

Memory addressing circuit

## Amplifier performance data

	1. Basic common-emitter amplifier		2. Feedback design		3. Worst case design		4. Cascode design	
<b>Circuit constraints</b>								
$V_{CC}$ (v)	3.0		3.0		3.0		4.0	
$R_L, R_D$ (K)	50, 50		50, 50		50, 50		50, 50	
$V_L$ (v)	0.3		0.3		0.3		0.3	
$T_y, T_z$ ( $^{\circ}$ C)	-50, +100		-50, +100		-50, +100		-50, +100	
<b>Circuit design</b>								
$V_{Rin}$ (v)	1.0	—	1.0	—	1.6	—	0.6	—
$V_{Rout}$ (v)	0.00	—	0.03	—	0.00	—	0.00	—
$V_a$ (v)	0.3	—	0.3	—	0.3	—	0.00	—
$I_b$ ( $\mu$ A)	0.3	—	0.3	—	0.3	—	0.3	—
$I_{Cn}$ ( $\mu$ A)	8.02	—	8.02	—	10.1	—	7.75	—
$R_C$ (K)	175	—	175	—	79.4	—	206	—
$K = K_y = K_z$	0.6	—	0.6	—	0.5	—	0.5	—
$\Delta R, \Delta V$	0, 0	—	0, 0	—	0, 10, 0	—	0, 0	—
$R_1$ (K)	125	—	125	—	159	—	77.4	—
$R_s$ (K)	0.0	—	3.89	—	0.0	—	0.0	—
$R_x, R_4$ (MEG)	2.77	—	2.56	—	5.66	—	0.343	1.63
$R_3, R_5$ (MEG)	2.54	—	2.45	—	2.60	—	0.030	1.44
<b>Circuit performance</b>								
	C	M	C	M	C	M	C	M
$I_{Cn}$ ( $\mu$ A)	4.93	4.90	4.93	4.90	5.02	5.04	4.03	4.1
$V_{CRD}$ (v)	1.52	1.50	1.54	1.60	1.69	1.67	1.85	1.9
$I_{Cz}$ ( $\mu$ A)	8.42	8.40	8.46	8.48	11.1	11.0	8.63	8.6
$V_{CRz}$ (v)	0.48	0.50	0.45	0.44	0.45	0.47	0.55	0.6
$P_{Dz}$ ( $\mu$ W)	27.1	27.0	27.3	27.9	34.7	34.5	52.9	52.8
$A_{iv}$	21.3	21.5	19.6	18.9	17.3	16.0	14.4	12.3
$A_{iz}$	63.2	60.0	50.0	49.2	56.8	54.0	33.2	30.7
$A_{yv}$	9.98	10.0	5.0	4.96	8.02	8.0	8.68	7.15
$A_{yz}$	10.2	10.3	5.06	5.00	10.6	10.0	10.9	10.3
$G_v$ (db)	23.3	23.0	19.9	19.7	21.4	21.0	21.0	19.4
$G_z$ (db)	28.1	27.9	25.0	24.0	27.8	27.3	25.6	25.0
$R_{iv}$ (K)	107	100	196	182	100	109	83.0	86.0
$R_{iz}$ (K)	311	290	493	482	269	249	152	149
$R_{yv}$ (K)	175	—	175	—	86	—	206	—
$R_{yz}$ (K)	175	—	175	—	86	—	206	—
$f_{idb1}^*$ (KC)	48.3	39.0	52.4	42.6	65	52.4	218	562
$f_{idb2}^*$ (KC)	10.1	9.9	12.5	12.2	17.4	17.0	110	82

\* = Measured values corrected for stray circuit capacitance

C—calculated,

M—measured

## Microelectronics

# How to design micropower transistor amplifiers: part 2

Commercially available transistors can be used to design common-emitter and cascode micropower amplifiers

By J.D. Meindl, R. Gilson, O. Pitzalis and W. Kiss

U.S. Army Electronics Research and Development Laboratories, Fort Monmouth, N.J.

The salient characteristics of micropower transistors and an optimum design technique for their use in broadband common emitter micropower amplifiers were presented in the first article of this two-

part series [Electronics, May 18, 1964, p. 73]. Now the problem of obtaining large amplifier bandwidths at microwatt power levels is discussed and the over all performance of both common-emitter

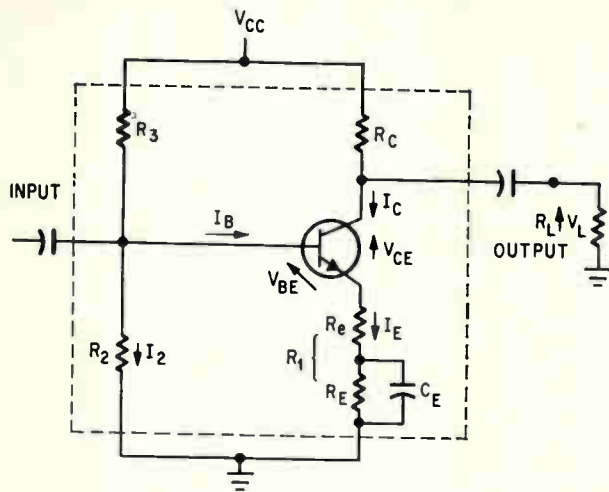

Common-emitter micropower amplifier operates from a three-volt supply with a load impedance of 50,000 ohms.

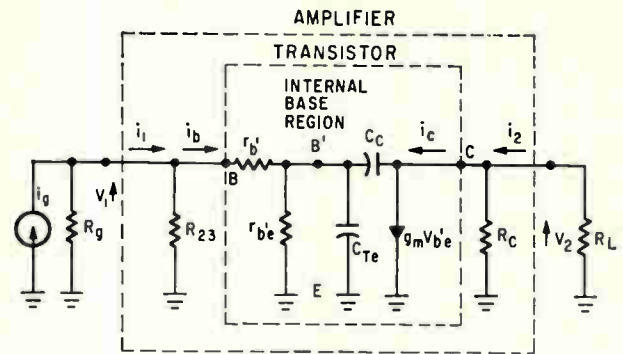

$r_b'$  = BASE SPREADING RESISTANCE (CAN BE NEGLECTED IN MICROPOWER CIRCUITS)  
 $r_{b'e}$  = COMMON-EMITTER DIFFUSION RESISTANCE  
 $C_{Te}$  = EMITTER JUNCTION CAPACITANCE

Small-signal a-c equivalent circuit of common-emitter micro amplifier incorporates the hybrid pi transistor equivalent circuit.

and cascode amplifiers, designed according to the procedure of the first article is examined.

The bandwidth of a common-emitter micropower amplifier can be exceeded significantly without loss of gain or increase in power consumption by means of a cascode circuit configuration (see below). A common-emitter broadband micropower amplifier operating from a three-volt supply with a load impedance of 50,000 ohms can provide a 0.18 v peak a-c load voltage over the temperature range  $-50 \leq T \leq 100^\circ\text{C}$  for a power drain of 25 microwatts and a power gain of 25 db. If the peak load voltage capability is reduced to 0.15 v, this amplifier can accept 10% worst-case tolerance margins on all circuit resistors. Depending on transistor barrier capacitances and stray circuit capacitances, amplifier bandwidth may vary from about 10 kc to 25 kc. Five times and larger increases are possible with the cascode circuit. Further extensions of bandwidth are readily possible for larger operating powers.

### Amplifier a-c characteristics

The a-c equivalent circuit of the common-emitter broadband amplifier described in the first article is illustrated above at right. The transistor is represented by the familiar hybrid pi equivalent circuit. Under the noncritical assumption that  $R_E$  and  $R_{23} \gg r_{b'e}$  and  $R_C \gg R_1$ , the current gain of the amplifier is

$$\frac{i_2}{i_1} \approx \frac{h_{fe}}{1 + j\omega r_{b'e} \left[ C_{Te} + \left( 1 + h_{fe} \frac{R_L}{r_{fe}} \right) C_C \right]} \quad (1)$$

and the bandwidth is

$$f_{3db} \approx \frac{1}{2\pi r_{b'e} \left[ C_{Te} + \left( 1 + h_{fe} \frac{R_L}{r_{b'e}} \right) C_C \right]} \quad (2)$$

Power dissipation,  $P_D$ , is given by the expression

$$P_D = V_{CC}(I_E + I_2) = V_{CC} \left[ I_E + \frac{V_{BE} + I_E R_1}{R_2} \right] \quad (3)$$

Dividing this into the gain bandwidth product

$$G\omega_{3db} \approx \frac{q}{kT} \frac{I_c}{C_c + C_{es}} \frac{1}{1 + R_L/R_c} \quad (4)$$

gives a number that can be considered a figure of merit for micropower amplifiers. In virtually all instances, a major objective in designing a broadband micropower amplifier is to achieve maximum

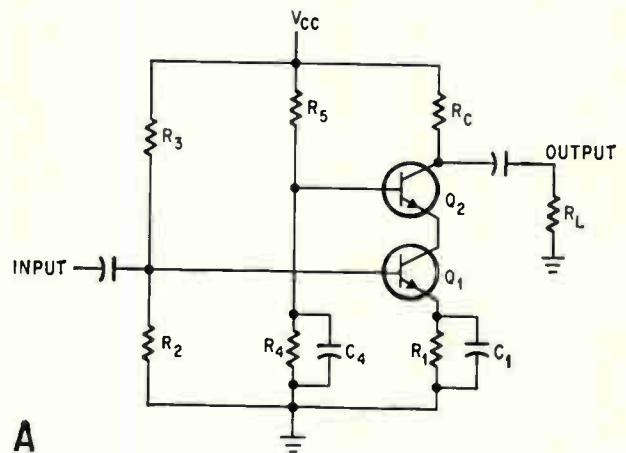

A

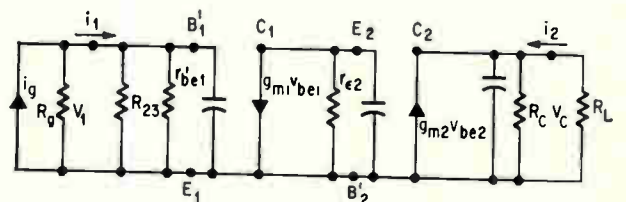

$r_{e2}$  = COMMON-BASE DIFFUSION RESISTANCE OF  $Q_2$

B

Cascode arrangement for micropower amplifier (A) and its a-c equivalent circuit (B) reduces the Miller effect limitation on bandwidth.

gain and a specified bandwidth for minimum power dissipation. Thus, the expression  $F.M. = G\omega_{3db}/P_D$  defines a parameter whose relative magnitude is a useful indication of the quality of a given micro-power amplifier design.

Equation 4 shows that the gain-bandwidth product of a common-emitter micropower amplifier can be improved by increasing the transistor collector current  $I_C$  (which increases power dissipation) and decreasing the transistor collector-to-base barrier capacitance  $C_C$  as well as the collector-to-base stray circuit capacitance  $C_{Cs}$ . Since  $C_C$  is usually of the order of 5 picofarads or less, the importance of minimizing the stray circuit capacitance  $C_{Cs}$  to maximize gain-bandwidth product is clear. It is evident from equation 1 that the usual Miller-effect capacitance

$$(1 + h_{fe} R_L/r_{b'e}) C_C$$

is an important limitation on micropower amplifier bandwidth. Frequently, the emitter junction capacitance  $C_{Te}$  is approximately equal to  $C_C$  for micropower transistors and the Miller-effect multiplier  $1 + h_{fe} (R_L/r_{b'e})$ , may be greater than 10 for a cascade of common-emitter stages.

A circuit found particularly effective in reducing the Miller-effect limitation on bandwidth is the cascode arrangement (bottom p 49). Again invoking the noncritical assumptions that  $R_g$  and  $R_{23} \gg r_{b'e}$  and  $R_C \gg R_L$ , the current gain and bandwidth equations 1 and 2 for the common-emitter stage also apply to the cascode amplifier except that the Miller-effect multiplier

$$\left(1 + h_{fe} \frac{r_{b'e}'/h_{je}}{r_{b'e}}\right) \approx 2$$

in the case of the cascode circuit. This reduction

of the Miller-effect multiplier by a factor of five or more permits significantly larger bandwidths for essentially the same current and power gain and only a slight increase in power consumption compared with the common emitter amplifier. (In practical micropower circuits stray capacitances can severely degrade amplifier bandwidth if proper interconnection techniques are not employed.)

The optimum design of a cascode amplifier can be accomplished by following the general pattern outlined for the common-emitter stage in the first article of this series. The principal modification is the selection of the quiescent collector voltage for  $Q_1$ . This voltage may be small due to the low value of the load impedance for  $Q_1$ . The cascode configuration provides a building block which is as universally useful and flexible in its applications as the common-emitter stage. Both circuits require only a single power supply. The cascode configuration has inherently less undesired feedback than the common-emitter stage because there is no feedback capacitor for  $Q_2$ . In addition, the current and voltage gains for both circuits are virtually identical. There is no requirement for matched transistors in the cascode arrangement. Finally, of primary importance for micropower electronics is the capability of the cascode circuit to provide significantly larger bandwidths than the common-emitter stage for relatively small increases in power consumption. It should be kept in mind, however, that the cascode circuit requires more components than the basic common-emitter amplifier.

### Amplifier performance

Detailed characteristics of four broadband micropower amplifiers designed according to the procedure in the first article are tabulated on p 48. The

### Design example

To illustrate the application of the design procedure, the steps in the basic design given in column 1 (Table page 48) for the circuit on p. 49 are enumerated below: For convenience, the equations used in this example, which appeared in Part I of this series, are repeated first.

$$I_{Cn} = \frac{V_{CC} - V_L - V_{R1n} - V_{Ren} - V_o}{V_{CC} - 2V_L - V_{R1n} - V_{Ren} - V_o} \left(\frac{V_L}{R_L} + I_o\right) \quad (a)$$

$$R_C = \frac{V_{CC} - 2V_L - V_{R1n} - V_{Ren} - V_o}{\frac{V_L}{R_L} + I_o} \quad (b)$$

$$\begin{aligned} I_{Cy(\min)} &= K_y V_L (1/R_C(\max) + 1/R_L) + I_o & (c) \\ V_{CEy} &= V_{CC(\min)} - I_{Cy(\min)} (R_{1(\max)} + R_C(\max)) & (d) \\ I_{Cx} &= (V_{CC(\min)} - V_{CEx(\min)}) / (R_{1(\min)} + R_C(\max)) & (e) \\ V_{CEx(\min)} &= K_x (V_L + V_{Ren}) + V_o & (f) \\ V_{CC(\min)} &= (I_{By(\max)} + I_{2y}) R_{3(\max)} + I_{2y} R_{2(\min)} & (g) \\ 0 &= V_{BEy(\max)} + I_{Ey} R_{1(\max)} - I_{2y} R_{2(\min)} & (h) \\ V_{CC(\min)} &= (I_{Bx(\min)} + I_{2x}) R_{3(\min)} + I_{2x} R_{2(\max)} & (i) \\ 0 &= V_{BEx(\min)} + I_{Ex} R_{1(\min)} - I_{2x} R_{2(\max)} & (j) \end{aligned}$$

1. The assumed constraints are  $V_{CC} = 3.0$  V,  $R_L = 50$  K,  $V_L = 0.3$  V and  $-50^\circ\text{C} \leq T \leq 100^\circ\text{C}$ .

2. Assume  $K = K_x = K_y \leq 0.6$  and  $V_{R1n} = 1.0$  V.

3. On the basis of the static collector characteristic curves for the transistor, select  $V_o = 0.3$  V and  $I_o = 0.3$   $\mu\text{A}$ .

4. From equations (a) and (b) compute  $R_C = 175$  K and  $I_{Cn} = 8.02$  microamperes.

5. From the relation  $R_1 = V_{R1n}/I_{Cn}$  compute  $R_1 = 125$  K.

6. The lower ( $I_{Cy} = 4.93$  microamperes,  $V_{CEy} = 1.52$  V) and upper ( $I_{Cx} = 8.42$  microamperes,  $V_{CEx} = 0.48$  V) temperature quiescent points are computed from equations (c), (d), (e) and (f) respectively.

7. Corresponding to the operating points computed in step 6 obtain the transistor base current and base-emitter voltage at the extremes of the temperature range ( $I_{By}$ ,  $V_{BEy}$ ) and ( $I_{Bx}$ ,  $V_{BEx}$ ) from the transistor spec sheet.

8. Substituting these data in equations (g) through (j) and solving simultaneously yields

$$R_3 = \frac{V_{CC}(I_{Ex} - I_{Ey})R_1 - (V_{BEy} - V_{BEx})}{(V_{BEx} + I_{Ex}R_1)I_{By} - (V_{BEy} + I_{Ey}R_1)I_{Bx}}$$

and

$$R_2 = \frac{R_3(V_{BEx} + I_{Ex}R_1)}{(V_{CC} - I_{Bx}R_3 - V_{BEx} - I_{Ex}R_1)}$$

which may be used directly to compute  $R_2 = 2.77$  megohms and  $R_3 = 2.54$  megohms.

9. From standard formulas such as 1, 2 and 3, the gain, bandwidth and power consumption of the amplifier should be computed. Their values are listed in column 1.

10. At this point, it is advisable to repeat steps 4 through 9 for several different values of  $V_{R1n}$  near the original 1.0 V value. Thus the design yielding the maximum gain-bandwidth product per unit of power consumption is determined.

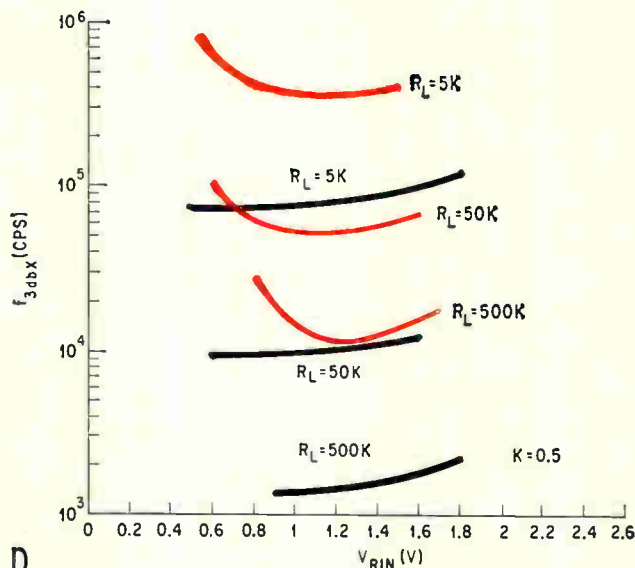
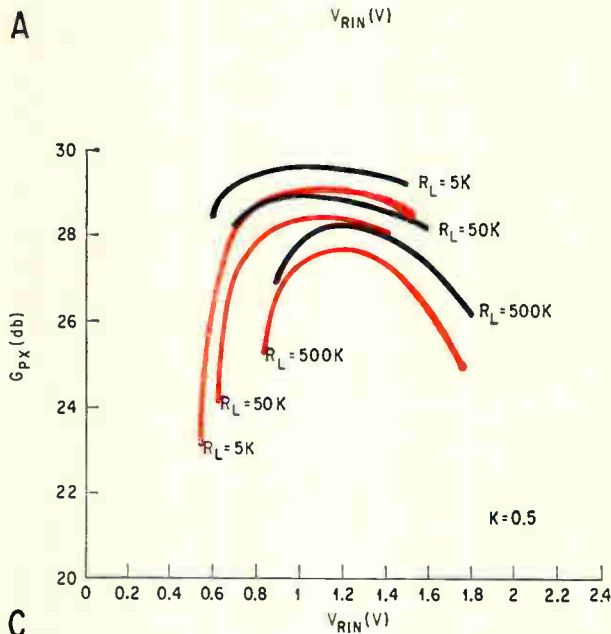
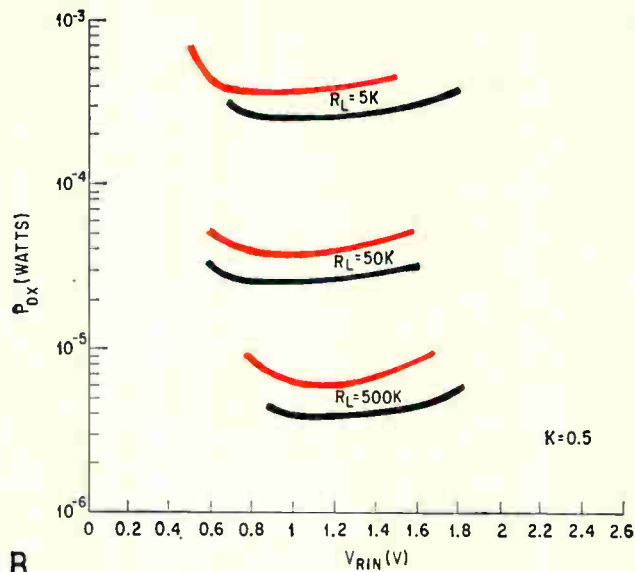
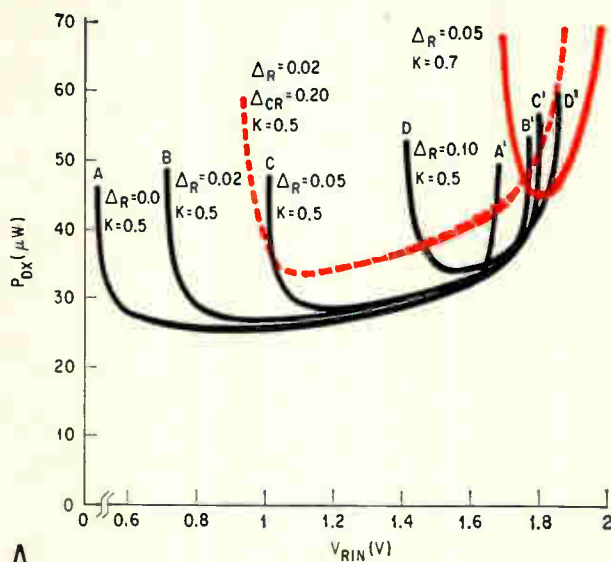

Power drain of circuit designed with a given resistor-tolerance margin can be minimized by adjusting the d-c emitter feedback voltage.  $V_{RIN}$  (A). Power drain of cascode amplifier (colored curves) is less than twice the drain of the common-emitter amplifier (B), while there is less than 1 db difference in power gain between the two circuits (C). Key advantage of cascode stage over common-emitter amplifier is the increased bandwidth (D).

transistor used in these circuits is similar to the 2N2784A planar epitaxial transistor. The common emitter amplifier designs of columns 1, 2 and 3 assume a supply voltage  $V_{CC} = 3v$ , a load impedance  $R_L = 50,000$  ohms, a required peak load voltage swing  $V_L = 0.3v$  and an operating temperature range  $-50 = T_y \leq T \leq T_x = 100^\circ C$ . The initial constraints of the cascode amplifier of column 4 differ only in that the supply voltage  $V_{CC} = 4v$ .

The optimum emitter d-c feedback voltage  $V_{RIN}$ , determined by comparing the power consumption and gain of several trial designs per column, ranges between 0.6v and 1.6 v as indicated. Only the design of column 2 employs a-c emitter feedback  $V_{RIN}$  which is selected as 10 percent of the peak load voltage swing, or 0.03v. The offset voltage which prevents saturation is  $V_o = 0.3v$  for all designs except the cascode where, due to the common-base

output transistor,  $V_o = 0$  is permissible. The offset current which prevents cutoff is  $I_o = 0.3$  micro-ampere for all designs. The minimum load voltage swing permitted at the operating temperature limits of  $T_y = -50^\circ C$  and  $T_x = 100^\circ C$  is  $KV_L = 0.18v$  for the designs of columns 1 and 2 and  $KV_L = 0.15v$  for the designs of columns 3 and 4.  $K$  is considered the dynamic range constant of the amplifier. Resistor and supply voltage tolerance margins are taken as 0% for all cases except for the design of column 3 where worst case resistor tolerances of 10% are assumed ( $\Delta R = 0.1$ ).

The optimum values for the resistors  $R_C$ ,  $R_1$ ,  $R_2$ ,  $R_3$ ,  $R_4$  and  $R_5$  are listed at the bottom of the circuit design portion of the table for each of the four amplifiers. The relatively small  $R_C = 79,400$  ohms for the worst case design results from the larger  $V_{RIN}$  required to combat the 10% resistor tolerance

margins. The larger  $R_C = 206,000$  ohms for the cascode design results from the lack of necessity for an offset voltage (that is,  $V_o = 0$ ) and the smaller optimum  $V_{Rin} = 0.6v$  resulting from a supply voltage  $V_{CC} = 4v$ . The relatively large  $R_2$  and  $R_3$  values for the worst case design are a consequence of greater d-c feedback ( $V_{Rin} = 1.6v$ ) and smaller limiting dynamic range ( $KV_L = 0.15v$ ). The reduced d-c feedback of the cascode design ( $V_{Rin} = 0.6v$ ) requires that  $R_2$  and  $R_3$  be relatively small for that circuit. A design example is provided in the panel on bottom of p 50.

### Comparing designs

A comparison of the calculated and measured circuit performance indicated in the table on page 48, reveals reasonable agreement. The quiescent point ( $I_C$ ,  $V_{CE}$ ), the current, voltage and power gains,  $A_i$ ,  $A_v$  and  $G$  respectively, the input and output impedances,  $R_i$  and  $R_o$  respectively, and the bandwidth  $f_{3db}$  of the amplifiers were measured and calculated at both of the operating temperature limits  $T_y$  and  $T_x$ . Considering the calculated performance of the basic amplifier of column 1, it is evident that over the operating temperature range: 1) collector current drifts from  $I_{C_y} = 4.93$  microamperes to  $I_{C_x} = 8.42$  microamperes; 2) collector voltage drifts from  $V_{CE_y} = 1.52v$  to  $V_{CE_x} = 0.48v$ ; 3) power drain at  $T_x$  is  $P_{D_x} = 27.1$  microwatts; 4) current gain varies from  $A_{i_y} = 21.3$  to  $A_{i_x} = 63.2$ ; 5) voltage gain varies from  $A_{v_y} = 9.98$  to  $A_{v_x} = 10.2$ ; 6) power gain varies from  $G_y = 23.3$  db to  $G_x = 28.1$  db; 7) input impedance varies from  $R_{i_y} = 107,000$  ohms to  $R_{i_x} = 311K$ ; 8) output impedance is fixed at  $R_o \cong R_C = 175,000$  ohms; and 9) bandwidth varies from  $f_{3db_y} = 48.3$  kc to  $f_{3db_x} = 10.1$  kc.

Compared with this performance, 1) the feedback design exhibits expected small improvements in the temperature stability of gain, input impedance and bandwidth; 2) the worst case design displays a slight increase in power consumption, slight decreases in gain and input impedance and a slight increase in bandwidth; and 3) the cascode design shows a moderate increase in power consumption, a moderate gain reduction and a substantial increase in bandwidth.

The tabulated data shows that a linear broadband micropower amplifier can be designed to accept 10% worst-case tolerance margins on all circuit resistors. In the past considerable attention has been given to worst-case d-c design techniques for digital circuits. While the effects of component tolerances generally have been considered more severe in linear circuits, apparently, practical analytical techniques for worst case design of linear circuits are not in wide use.

In terms of the most sensitive indicator of component tolerance margins, circuit power consumption, graph (A) displays the effects of resistor tolerances in linear micropower amplifiers designed according to the procedure outlined in part I.

The graph shows power consumption  $P_{D_x}$  of a

common-emitter amplifier, similar to that of column 1 in the table (p 48) at a temperature of  $100^\circ C$  versus the nominal emitter d-c feedback voltage  $V_{Rin}$  for various worst-case resistor tolerance margins  $\Delta_R$  constant-ratio resistor tolerance margins  $\Delta_{CR}$  and dynamic range constants  $K$ . Curves AA', BB', CC', and DD' indicate that for worst-case resistor tolerance margins of 0%, 2%, 5% and 10% respectively, and a dynamic range constant  $K = 0.5$  (the dynamic range at  $T_x$  and  $T_y$  is  $KV_L = 0.5 V_L$ ) circuit power consumption can be held to acceptable amounts by increasing the minimum value of  $V_{Rin}$  and holding it below a nearly fixed maximum. The sharp minimum in curve DD' indicates an extremely narrow design range for 10 percent worst case resistor tolerances.

The colored curve with  $K = 0.7$  illustrates the adverse effect of attempting to design for a dynamic temperature stability which is too demanding. This curve is comparable to the curve CC' ( $K = 0.5$ ) except for the dynamic range constant.

The dashed curve illustrates the combined effects of a 2 percent worst case resistor tolerance combined with a 20% constant ratio tolerance in which all resistors are assumed to be off the design center by 20% in the same direction. This case occurs in the batch processing used to fabricate resistors in silicon integrated circuits and thin film circuits. Graph (A) indicates that given constant ratios, rather large (20 percent) absolute tolerance margins can be accepted by a linear circuit.

Graphs (B), (C) and (D) compare the critical performance features of power consumption  $P_{D_x}$ , power gain  $G_x$  and bandwidth  $f_{3dbx}$  at the maximum operating temperature  $T_x$  for a large number of common emitter and cascode circuit designs with load impedances extending from  $R_L = 5 K$  to  $R_L = 500,000$  ohms. The remaining circuit constraints are similar to those in the table on p 48. Graph (B) indicates that the power consumption (colored curves) of a cascode amplifier runs about twice that of a common emitter stage (black curves). Graph (C) indicates that there is less than 1db difference in power gain between the two circuits. Finally, (D) indicates that there is a five-to-ten-times increase in bandwidth for the cascode stage. In general, the results of (B), (C) and (D) show that a cascode stage is capable of delivering a significantly larger gain-bandwidth product per unit of power consumption than a common-emitter stage. This capability combined with the over all flexibility of the cascode configuration mark it as a strong candidate for a general purpose micropower amplifier stage.

It is evident that the principal obstacle to be overcome in the broader application of micropower transistors in portable military communications equipment is the limited gain-bandwidth product of micropower devices and circuits. In order to improve device and circuit frequency response, transistor junction capacitances, header capacitances and stray circuit capacitances must be reduced about an order of magnitude.

The compact leakage-current tester is light-weight and battery-powered for convenient use in the field as well as in the laboratory.

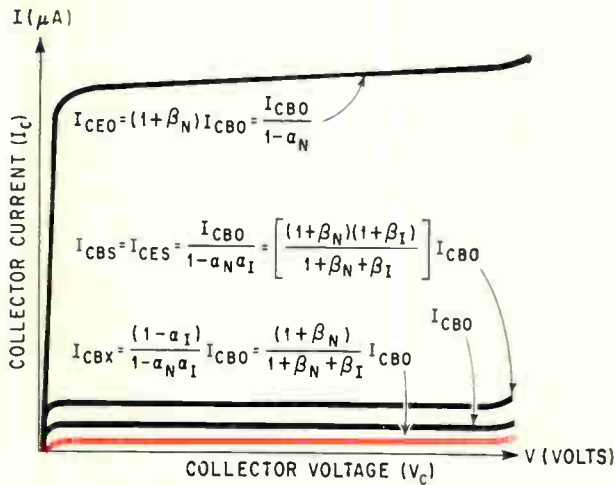
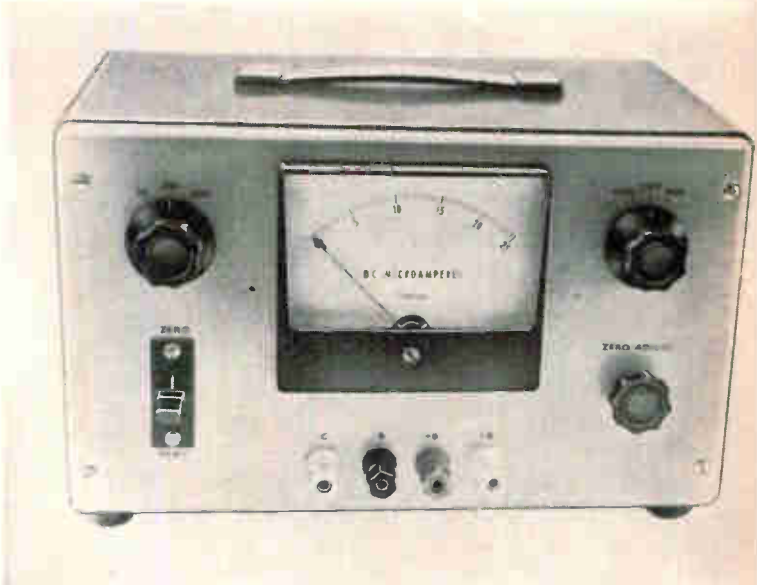

Chart shows relationship that permits use of  $I_{CBX}$  for  $I_{CBO}$ .

## Instrumentation

# Testing transistors in-circuit

Leakage is checked by measuring collector current with collector and emitter junctions reverse-biased

By A.T. Ashby,\* T.R. Shaifer and H.R. Hegner

IIT Research Institute (formerly Armour Research Foundation), Chicago

**Leakage current** is an accurate and reliable indicator of a transistor's quality. Excessive leakage is a forerunner of most transistor failures except short circuits and open circuits.

Commercial instruments are available that provide accurate measurements of transistor leakage out-of-circuit. Now an in-circuit tester has been developed that measures transistor leakage current accurately in any kind of circuit. It's light, easy to

operate, and battery-powered for portable field use. It should be an invaluable aid to circuit development in the laboratory or as a field maintenance tool.

The device measures transistor leakage current  $I_{CBX}$ , which is the collector current when both the collector and emitter junctions of the transistor are

\* Now with the Stewart-Warner Corp., Chicago

## Setting up the test

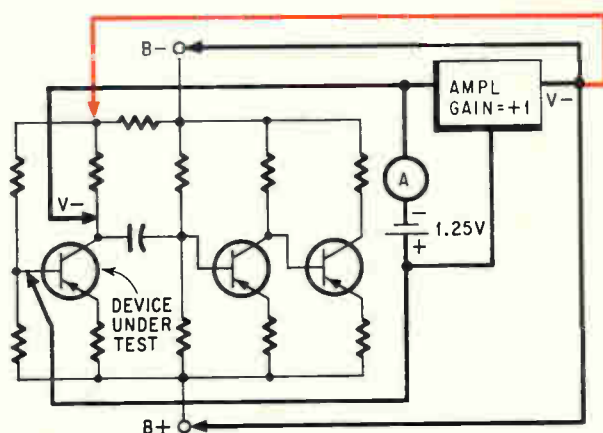

Typical test setup for measuring leakage current. Colored line shows extra bootstrap lead required for checking decoupled stage.

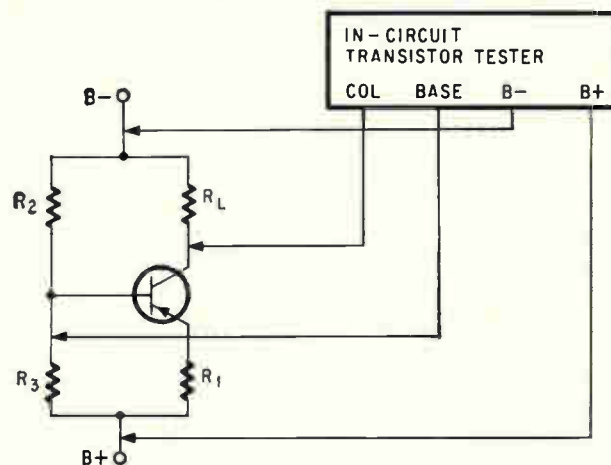

Only four connections—one each to the B+, B-, base and collector—are required for measurements. In certain cases, an additional bootstrap connection is needed.

reverse-biased. This leakage current was chosen because it is nearly independent of the gain parameters of the transistor, and also because it is a close approximation to the fundamental leakage current—the collector current ( $I_{CBO}$ ) that flows when the collector junction is reverse biased and emitter junction is open circuited.

The instrument can measure leakage currents as low as one microampere with a collector load resistance as low as 500 ohms.

Of the various leakage currents defined for transistors (see chart), the collector and emitter currents ( $I_{CBO}$  and  $I_{EBO}$ ) are fundamental. The others are functions of these two.

Measuring fundamental leakage currents in the circuit is not possible because  $I_{CBO}$  is measured with the emitter open-circuited and  $I_{EBO}$  with the

collector open-circuited, and neither electrode of a transistor is ever operated in an open condition.

Current  $I_{CBX}$ —the collector current when both the collector and emitter junctions of the transistor are reverse biased—is nearly independent of the gain parameters of the transistor, and it is a very close approximation of  $I_{CBO}$ ; particularly when a transistor has a great deal of surface leakage across the collector junction.

Since leakage currents  $I_{CBO}$  and  $I_{CBX}$  are normally within 5% of each other and the deterioration of a transistor is indicated by increased surface leakage, the measurement of  $I_{CBX}$  gives a good indication of a device's dependability.

### Test connections

The base of the transistor is used as a reference



## Inside the tester

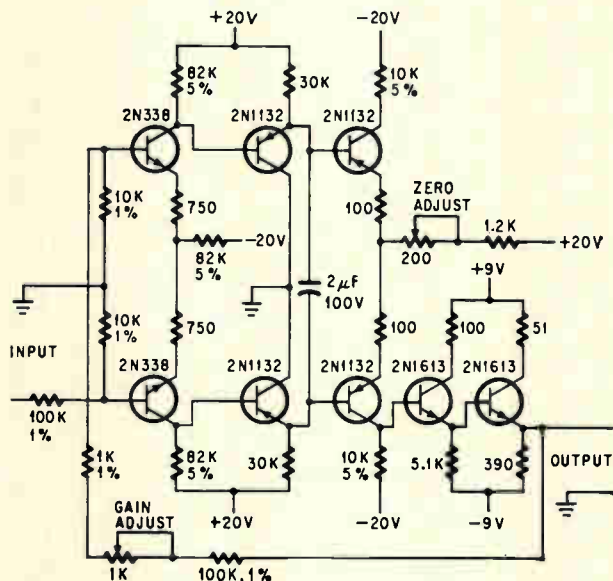

Unity-gain d-c amplifier (shown as a block in the over-all schematic) has a gain of +1 that is accurate to four significant figures.

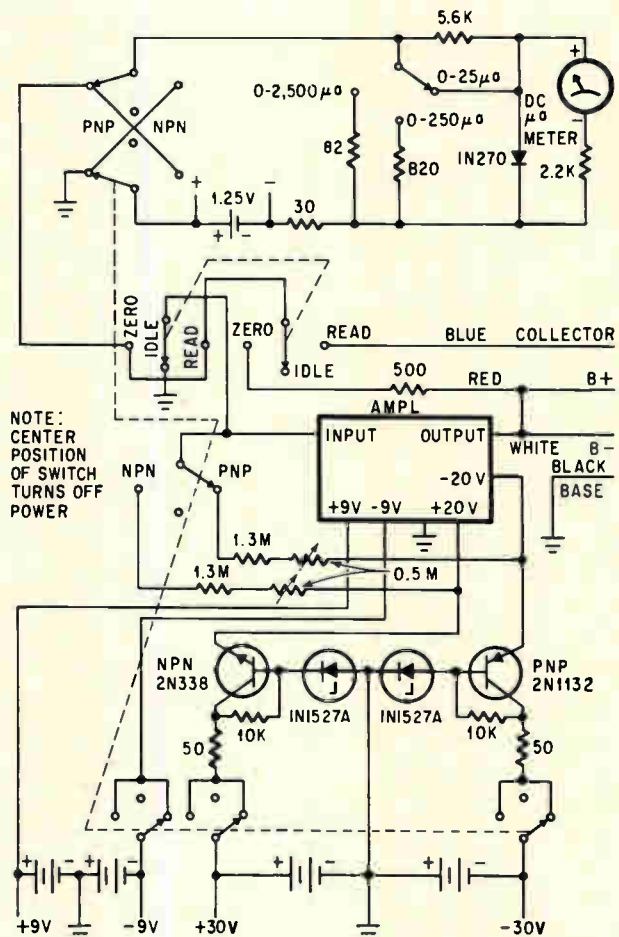

All switching is accomplished with two multipole, three-position switches. The center position of the npn-pnp switch turns off the tester.

for making in-circuits measurements. A voltage source, in series with a microammeter, is connected between the base and collector of the transistor stage (see figure). The input terminals of a unity-gain d-c amplifier are also connected across the base and collector of the transistor.

The voltage appearing at the collector ( $-V$ ) also appears across the d-c amplifier, which has a low output impedance. The output of the amplifier is used to bootstrap all impedance paths leading from the collector of the transistor being tested—that is, to make the potential difference across the shunt paths zero. Thus the only current supplied by the voltage source is the transistor collector current. The output of the amplifier is also used to reverse-bias the emitter junction of the transistor. Under these conditions, the collector current flowing in

the transistor will be  $I_{CBX}$ .

Four simple connections to the circuit—one to the base of the transistor, one to the collector, one to  $B+$  and one to  $B-$ —are required to test a single-battery biased stage. This scheme will work for any number of cascaded single-battery bias stages if the unity-gain d-c amplifier output remains connected to the  $B+$  and  $B-$  terminals of the circuit under test and the base and collector test leads are changed to another transistor.

The tester can be used on all basic transistor circuits. The test procedure will work for all a-c or d-c coupled stages, as long as the d-c collector resistance in the transistor stage is greater than some lower resistance limit. This limit is determined by the measurement accuracy required, the amplifier limitations and the resolution desired. For

this tester, the lower resistance limit is 100 ohms to read current within  $\pm 1$  microampere, or 1,000 ohms for current within  $\pm 0.1 \mu\text{a}$ . If a stage is decoupled from the B+ or B- terminals by a resistor and filter capacitor, an auxiliary lead from the output of the unity-gain amplifier must be connected to the decoupled point in addition to the B+ and B- connections.

### Differential d-c amplifier

The amplifier of the tester, the heart of the instrument, has a gain of +1 that is accurate to four significant figures, an output impedance of approximately 0.01 ohm, and an output signal capability of  $\pm 1.2$  volts across a 100-ohm lead. Negative feedback around a transistorized d-c amplifier with a differential input and a single-ended output gives the required gain stability and low-output impedance. The differential input is necessary to obtain low d-c drift and positive gain. The amplifier operates from a partly regulated battery-power supply. The batteries have sufficient capacity for 150 to 200 hours of operation. The instrument contains a 1.25-volt nickel cadmium battery for a signal source and a 0- to 25-  $\mu\text{a}$  meter for readout.

### Sample procedure

Here's how the tester is used on this stage (see diagrams):

First, no internal power should be supplied to the circuit at the B+ and B- terminals. Second, the proper connections are made to the circuit as depicted in the diagram, and the "npn-off-pnp" switch is positioned to npn or pnp, depending on the polarity of the device being tested. Third, the current range switch is set at the value of leakage current expected (25, 250 or 2500  $\mu\text{a}$ ). Fourth, the zero-read switch is positioned up to the zero position, and the zero adjust control is adjusted until

the meter is at zero. Fifth, the zero-read switch is positioned to the read position, and the meter reading is the transistor collector leakage current.

If it is desired to measure leakage currents on the order of one microampere with at least  $\pm 20\%$  accuracy (see figure), then  $R_L$  must not be lower than 500 ohms. The accuracy goes up as  $R_L$  increases, and is within  $\pm 50\%$  at one microampere with  $R_L$  greater than 2,500 ohms if the instrument is properly zeroed.

Besides considerations of  $R_L$ , the parallel combination of  $R_2$  and  $R_3$  should be 100 ohms or more because these resistors are connected directly across the output of the unity-gain d-c amplifier in the tester. If this resistance ( $R_2$  and  $R_3$ ) is lower than 100 ohms, the gain of the d-c amplifier may be reduced, introducing errors in the reading. The resistance limitations noted are caused by limitations of the unity-gain d-c amplifier. There should be no great difficulty in developing a d-c amplifier that would improve the resolution of the instrument at least another order of magnitude ( $0.1 \mu\text{a} \pm 20\%$  at  $R_L = 500$  ohms), or to allow measurement of resistance levels an order of magnitude lower in the present resolution levels ( $1 \mu\text{a} \pm 20\%$  at  $R_L = 50$  ohms). This would probably require a chopper-stabilizer d-c amplifier instead of a d-c differential amplifier. The chopper-stabilizer amplifier would also eliminate the need to zero the instrument before a reading was taken.

The in-circuit tester described in this article eliminates the need for physically removing soldered or wired-in transistors from their circuits. Since only a small percentage of transistors are currently being manufactured with rigid pins for use with sockets, the tester has widespread potential application.

### The authors



Alan T. Ashby has twelve years of experience in electronics including the development of various counter-countermeasure devices and in various radar-system evaluation. At the IIT Research Institute he worked on various programs concerned with beacon and satellite instrumentation.



Theodore R. Shaifer has worked on advanced circuit development for three years at the IIT Research Institute. He was also involved in transistor circuit development for television receivers, including horizontal and vertical deflection, circuits, video circuits, and IF circuits.

### Bibliography

1. Robinson, V. I., Design of a Field Transistor Tester, *Electronic Equipment Engineering*, June 1960, pp. 50-55.
2. Mooers, H. T., and Zelinka, R. J., The Advantages of Tetraode Geometry for Power Transistors; Stability and Control of Amplified Leakage Current, *Semiconductor Products*, April 1959, Vol. 2, No. 4, pp. 29-34.
3. Cleary, J. F., G. E. Transistor Manual, Sixth Edition, 1962, pp. 65-73.
4. Hurley, R. B., *Junction Transistor Electronics*, John Wiley and Sons, Inc, 1958, pp. 110-112, 149-152, and 343-345.
5. Dewitt, D., and Rossoff, A. L., *Transistor Electronics*, McGraw-Hill Book Company, Inc., 1957, pp. 57-65.

The authors thank the Army Electronics Research and development Laboratory at Fort Monmouth, N.J.



Henry R. Hegner has six years experience in electronic controls and instrumentation. At the IIT Research Institute he is presently engaged in the design and development of a solid state counter-countermeasure missile system. Previously, he studied corona interference on ships and cross-interference between sonar links for the Navy. He has developed instrumentation for locating faults on the open wire transmission lines and in system modules.

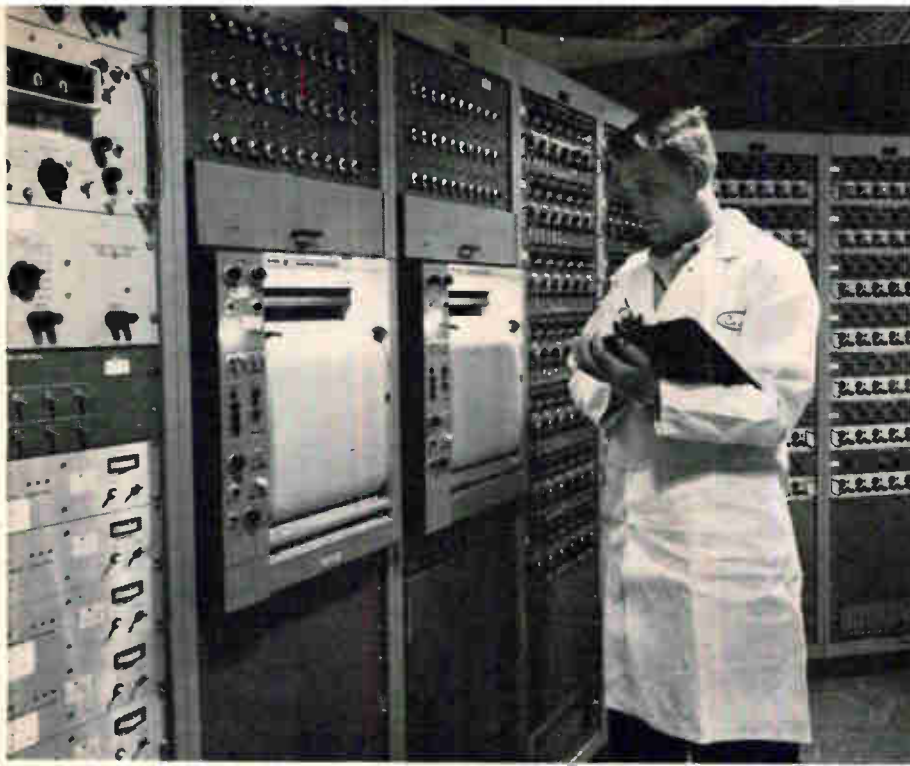

Data acquired in test-firings of mammoth rocket boosters have been recorded by newly developed system. The analog input can be converted to digital readout.

## Instrumentation

# Data acquisition system expects the unexpected

System used in rocket test-firings can record in the analog mode to get full dynamic range and play back, with high accuracy, in either the analog or digital mode

By Laurence D. Shergalis

Regional Editor

Anything can happen during a rocket test-firing. The information bandwidth isn't always known. Phenomena may be unpredictable. Hundreds of parameters must be measured. There may be an emergency involving a failure condition. Unless data is recorded over its full range, the reasons for a failure could be lost and transient analysis would not be possible.

These were some of the problems faced by engi-

neers at the Vidar Corp. and the United Technological Center, a division of the United Aircraft Corp. during their recent test firings of the giant Titan booster. Neither the conventional digital system (ideal for production work) nor the straight analog approach (where accuracy suffers) met their requirements. They turned the neat trick of developing a data acquisition system which combined the best features of both methods—the flexibility and

economy of analog recording and the accuracy of digital techniques.

### Making a choice

When specifying or designing a data acquisition system, an engineer decides between the digital and the analog method. His choice usually depends upon the application. For example, production data involves certain variables whose limits are set by specifications prepared in advance.

Digital data acquisition systems are best for production work. Although the systems are bandwidth limited, a sampling rate can be chosen to accommodate predicted data. Since equipment to record unlikely events isn't needed in the system, costs can be held to a minimum.

In experimentation many variables have to be scanned simultaneously. Their behavior is often unpredictable. The data acquisition system must be capable of recording unexpected excursions of the variables being monitored. An analog system will satisfy these requirements but it won't be as accurate as a digital system.

### This makes the difference

In the United Technology Center's system, signals from low-level transducer outputs are fed to voltage-controlled oscillators that convert the signal voltages to a frequency. The f-m signals are mixed (multiplexed) and recorded on tape as a complex waveform containing several channels of information. At this point the system differs from the conventional. Data may be played back either in digital form at an over-all system accuracy of about 0.1%, or it may be played back in analog form and recorded on oscillographs with an accuracy of about 3%. The reduced accuracy of analog presentation is due to inaccuracies in the oscillograph and in the eye of the human reader.

Each element of the system consists of 12 input channels. Six of these are wideband with 20-kc capability. Each wideband channel feeds into a single-voltage-controlled oscillator whose output is recorded directly onto one tape track. The other six channels are narrowband with 2-kc capability. All 12 channels are combined by a multiplexing scheme and recorded as an extremely complex wave on another tape track. With the system, up to 78 channels of 1- to 2-kc continuous data can be recorded on one 14-channel tape recorder. Thirteen channels accommodate six tracks each, and the fourteenth is the "trash" track for timing, etc.

### Voltage-controlled oscillator

The key component in this high-density data recording system is the voltage-controlled oscillator. In its basic configuration it resembles an operational amplifier. There is a series input resistor; a means of providing feedback current; a node at which the input current and the feedback current are summed; and a high-gain amplifier responsive to the difference between the input current and the feedback current (Figures, page 59).

---

### Reaping the benefits

- Less complex and less costly than a digital system.
  - More accurate than a conventional analog system.
  - Gets full dynamic range of data. System will accommodate any transducer and accept its full capabilities.
  - Provides a "road map" of the acquired data analog form to guide the data reduction section. Permits the project engineer to eliminate reduction of data that doesn't appear to be significant.
  - Within about 30 minutes trend data on the tests is available. Within 48 hours there is sufficient data on a major test project to definitely indicate success or failure.
- 

In a conventional operational amplifier, when current at the node is balanced, the voltage gain may be extremely high by using precision resistors and a high-gain amplifier whose input error voltage is kept very small via the feedback loop.

This voltage-controlled oscillator differs from the familiar operational amplifier only in that feedback to the summing node consists of a train of constant-charge current pulses rather than a steady feedback current. Thus the feedback resistor of the conventional operational amplifier is replaced by a circuit which issues a current pulse containing a predetermined and constant charge whenever the voltage level reaches a predetermined value in the amplifier. This circuit is called a standard charge dispenser, abbreviated SCD.

Polarity of the current pulses from the SCD is opposite to the input current so that a balance of the average currents reaching the node is achieved when the average current from the SCD pulse is constant. The average feedback current is proportional to the rate, or frequency of the SCD pulses. Thus, to keep the current at the summing node balanced, the SCD operates at a rate proportional to input voltage.

Prior to a time  $T_1$ , input voltage  $e_{in}$  is zero. The amplifier is arranged so that virtually zero current flows in its input lead and its input voltage off-set (error) is practically zero. There is, therefore, no tendency for  $e_i$  to depart from zero so long as  $e_{in}$  remains zero. At  $T_1$ ,  $e_{in}$  jumps to some intermediate value. This input voltage is impressed across  $R_{in}$  and causes a charging current to flow into  $C_i$ , an integrating capacitor placed at the summing node (see plot, page 59).

Responding to the input current,  $C_i$  charges linearly as shown on the  $e_i$  plot. The amplifier gain is approximately  $-200$  so that when  $e_i$  reaches  $+10$  mv, the amplifier output reaches  $-2$  volts. Two volts at its control terminal are sufficient to cause the SCD to trigger, with a resultant current pulse as shown on the  $i_{FB}$  or feedback current plot. The current pulse partially discharges  $C_i$  as shown in the plot of  $e_i$ . Thus  $e_i$  is reduced below the level at which the SCD will fire and the SCD remains quiescent until  $e_i$  again reaches the firing level. This process continues with the SCD firing just

## Voltage-to-frequency converter

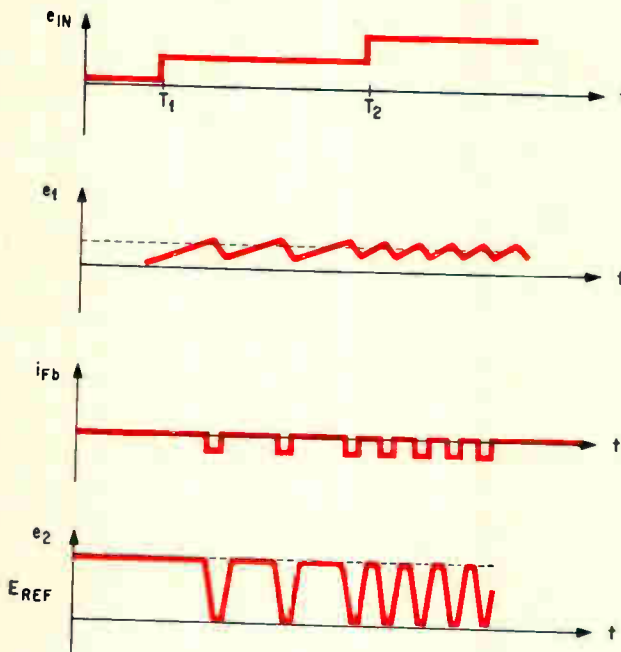

often enough to prevent  $C_1$  from ever charging to more than about 10 mv.

The voltage on  $C_1$  is thus held near zero. For the voltage on a capacitor to remain zero indefinitely, the average current entering the capacitor must be zero. In this case, this condition is satisfied only if the average feedback current is equal and opposite to the input current which is proportional to the input voltage. Since the charge content of each SCD pulse is constant, the average feedback current is proportional to the SCD pulse rate or frequency. Therefore, in maintaining the average node current at zero, the amplifier forces a precise proportionality between the frequency of SCD operation and the input voltage. Each cycle of operation is independent of the previous history of the circuit so that an abrupt change of input voltage causes an abrupt change in frequency.

### Constant charge

To produce constant-charge current pulses, the SCD makes use of the fact that the charge on a capacitor is the product of its capacitance times its voltage, so that a given change of capacitor voltage is always accompanied by the flow of a given charge through the capacitor leads. In the SCD a very stable capacitor is alternately charged to a precisely controlled voltage and discharged to another precisely controlled voltage. By means of steering diodes the charging current pulses are routed to the summing node.

One end of capacitor  $C_p$  is initially charged to a reference voltage furnished by a highly stable 45-volt power supply. When the amplifier output reaches a predetermined level a one-shot multivibrator in the SCD fires. Firing of the multivibrator causes  $e_2$  to swing to zero. At the conclusion of the multivibrator period,  $e_2$  swings back to  $E_{ref}$ . The

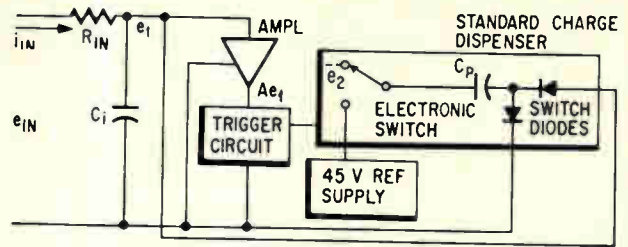

In voltage to frequency converter, unknown signal  $e_{in}$  comes from the transducer developing an unknown current  $i_{in}$  across resistor  $R_{in}$ . Current  $i_{in}$  flows into capacitor  $C_1$  which develops a voltage  $e_1$ . Voltage  $e_1$  is sensed by the amplifier and amplified  $A$  times resulting in  $Ae_1$  being fed into the trigger. Current pulses are developed and sent back via the feedback loop to neutralize the charges on  $C_1$ .

◀ Circuit performance of the VCO versus time, starting at the top with the unknown input voltage from the transducer going through two abrupt changes and the corresponding change in voltage  $e_1$ . Feedback pulses  $i_{fb}$  change frequency in accordance with input voltage, resulting from the waveform at the output of the trigger circuit.

other terminal of  $C_p$  is connected to two steering diodes so that the charging current is routed to ground while the discharging current is routed to the summing node. Thus each firing of the multivibrator in the SCD causes a negative current pulse to be fed to the summing node.

The forward drop in the steering diodes subtracts from the voltage change experienced by  $C_p$  in a manner analogous to backlash in a mechanical linkage. Since this diode drop is temperature-dependent, it is necessary to introduce a compensating temperature-dependence in the swing of  $e_2$ . A series string of clamp diodes is used. Temperature-induced changes in forward-drop in these diodes compensate for changes in steering-diode drop with the result that the SCD pulse charge content changes almost not at all—less than 0.01 percent per degree C.

### Multiplexer

Pulse trains of  $15 \text{ kc} \pm 5 \text{ kc}$  from each voltage-controlled oscillator, are applied to binary flip-flops, and low-pass filters converting the oscillator outputs to sine waves at  $7.5 \text{ kc} \pm 2.5 \text{ kc}$ . The first channel is fed directly to the low-group mixing amplifier. Low-pass filter outputs of channels 2 and 3 are applied to balanced modulators. The frequency of the carrier applied to these modulators is  $33\frac{1}{3} \text{ kc}$ , derived from the 100 kc reference input. The output of these modulators includes a lower sideband centered at 25.833 kc, an upper sideband at 40.833 kc, and numerous higher harmonics. In channel 2 the lower sideband is selected by a bandpass filter while the upper sideband is preserved in channel 3. These two translated channels are then applied to the low-group mixing amplifier along with untranslated channel 1.

Channels 4, 5, and 6 are duplicates of channels

1, 2, and 3 and are called the high group. The 100 kc reference frequency is amplified and applied as a carrier frequency, along with the high group composite signal, to a balanced modulator. A 50-100 kc bandpass filter preserves the lower sideband.

The 100 kc is also doubled and then divided by six to provide the 33 1/3 kc modulating frequency for the initial modulators in channels 2, 3, 5, and 6. The reason for doubling and then dividing by six rather than merely dividing 100 kc by three is so that the last stage of the divide-by-six section can be a binary flip-flop or multivibrator, thereby providing a properly symmetrical squarewave to the modulators.

The doubler output of 200 kc is mixed, along with the low group and the translated high group to form the complete composite signal for recording on a single channel of the tape recorder. The 2 kc is used as a pilot carrier to generate the 33 1/3 kc and 100 kc required in the playback process. Since the tape recorders supplied in this system had a 250 kc bandwidth, 200 kc rather than 100 kc was used as the pilot to provide a greater separation between it and other multiplex signals and also to provide available spectrum for possible future expansion of the system.

### Analog playback

This process is just the reverse of that in the multiplexer. The composite multiplex signal from the direct reproduce amplifier of the tape recorder is amplified, applied to a 200 kc bandpass filter for extraction of the pilot carrier, to a 50-100 kc bandpass filter for separation of the translated high group, and directly to the low-group input filters.

The low-pass filter of channel 1 and the bandpass filters of channel 2 and 3 isolate their respective carriers. Bandpass filter outputs are applied to balanced modulators excited with 33 1/3 kc. The outputs of these modulators include the difference frequency at 7.5 kc, the sum frequency and many other higher order components. A low-pass filter effectively separates the 7.5 kc difference frequency from the other components.

The output of the 50-100 kc filter includes the high-group channels. Modulating this output with 100 kc translates the high group down to 7.5 kc, 25.833 kc and 40.833 kc again. Channels 4, 5, and 6 are then recovered exactly as described for channels 1, 2, and 3.

The pilot carrier is isolated with the 200 kc band-

## Multiplexing . . .

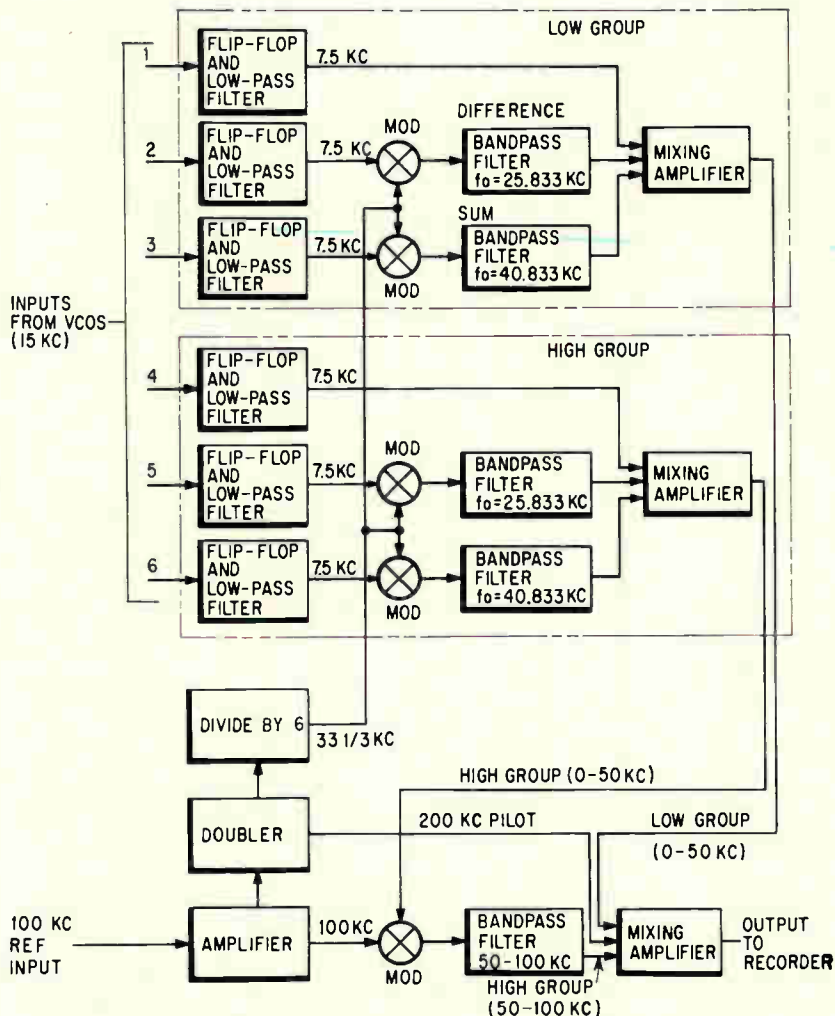

In multiplexer narrow band channels of the system are mixed and fed as one composite waveform to one channel of a tape recorder

pass filter. Dividing the 200 kc by two provides a 100 kc output as well as the excitation for the high-group demodulator. Excitation for the 33 1/3 kc modulators is derived from 200 kc by dividing by six.

The low-pass filters at the output of each channel include phase equalizers which correct the time delay of the entire transmission channel. Harmonic distortion components are reduced approximately 6 db through the use of the equalizers.

### Digital playback

The digital data processor uses frequency counter techniques to generate digital numbers related to the analog voltages present at the input of the VCOs. Since the frequency output of the VCO is precisely proportional to the analog input voltage a simple frequency counter measuring the recorded frequency provides digital representation. However, to meet special system requirements several unusual features have been included.

### Frequency counters

An important measurement in rocket motor test-



# Designer's casebook

## Added capacitor sweeps power supply

By Milton H. Crothers

Associate Professor of Electrical Engineering  
University of Illinois, Urbana, Ill.

For laboratory demonstrations, slow-voltage sweeping operation of a standard transistor-regulated power supply was achieved by placing an electrolytic capacitor across the external voltage-control terminals. With this simple modification, the variable supply was used with an X-Y plotter to present varied characteristics of devices and complete systems. The ramp function obtained had adequate linearity. High linearity cannot be expected when an electrolytic capacitor is used.

The power supply used was a Harrison Laboratory model 865B, which has a specification of one volt per 500 ohms, equivalent to a charging current of two milliamperes for the capacitor. With a capacitor of 1,000 microfarads, this represents a voltage-charging rate of two volts per second. Many other types of standard supplies can be used.

The push-type switch ( $S_1$ ), which is normally closed, holds the capacitor at zero voltage until the sweep cycle is ready to begin. The multiposition switch ( $S_2$ ) connects to a series string of five zener diodes which clamps the maximum voltage value.

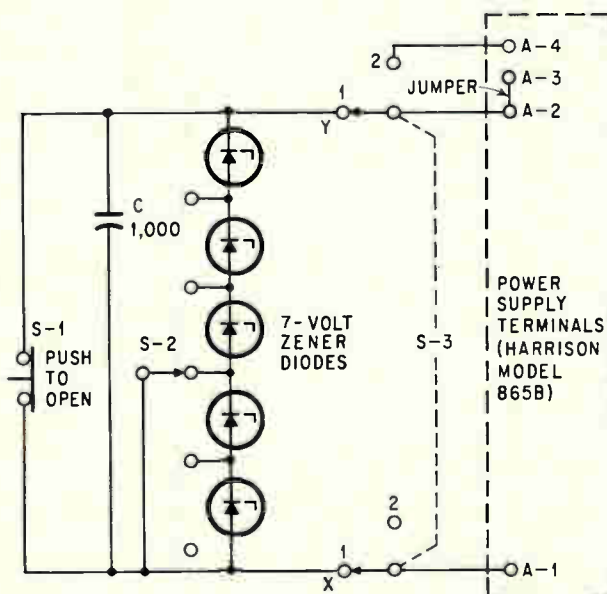

Addition of a 1,000- $\mu$ f, 50-volt electrolytic capacitor to a standard transistor power supply allows slow voltage sweeping for classroom demonstrations.

Designer's casebook is a regular feature in Electronics. Readers are invited to submit novel circuit ideas, packaging schemes, or other unusual solutions to design problems. Descriptions should be short. We'll pay \$50 for each item published.

Diodes with a nominal avalanche breakdown voltage of seven volts each were used because the maximum rated voltage for the power supply was 40 volts.

During the sweep cycle, the zener diodes should not be switched, as a surge will damage them. The push-type switch, which is normally closed, provides protection as long as the diodes are not switched during operation.

Another switch ( $S_3$ ) was added for direct switching between normal operation and slow-sweep operation. With  $S_3$  in position 1, the slow-sweep network is connected to terminals A1 and A3. When  $S_3$  is moved to position 2, the slow-sweep circuit is removed and points A2, A3 and A4 are tied together.

## Silicon controlled rectifier triggers ignitron

By Louis E. Frenzel, Jr.

McCollum Laboratories, Inc., Houston, Texas

In this ignitron circuit, the thyatron or trigger tube normally used to control the ignitor current is replaced by a silicon controlled rectifier (SCR). This eliminates the heater and bias supplies required by the thyatron and reduces overall circuit size, weight and cost.

To turn on the silicon controlled rectifier, a positive six-volt pulse is applied to its gate. The SCR then supplies a high current pulse to the ignitor, turning on the ignitron. Capacitor  $C_1$ , which had been charged to nearly 300 volts by the supply voltage through  $R_1$ , now discharges rapidly through  $R_L$  and the ignitron. Momentarily, the entire 300 volts appears across  $R_L$ . The discharge time constant depends upon  $R_L$ ,  $C_1$  and the ignitron "on" resistance. If  $R_L$  is much greater than the ignitron "on" resistance, then the discharge time may be considered as depending upon  $R_L$  and  $C_1$  only. In this circuit, the ignitron "on" resistance is approximately 0.05 ohm. A one-ohm resistor is used for  $R_L$ .

The voltage waveform across the load resistor consists of a sharp rise followed by exponential decay. The rise time is approximately three microseconds. The pulse width is approximately 0.91 millisecond and may be calculated from the formula:  $t = 0.69 R_L C_1$ . For the component values specified, the maximum repetition rate is one pulse every 130 seconds (equivalent to a frequency of 0.0077 cps).



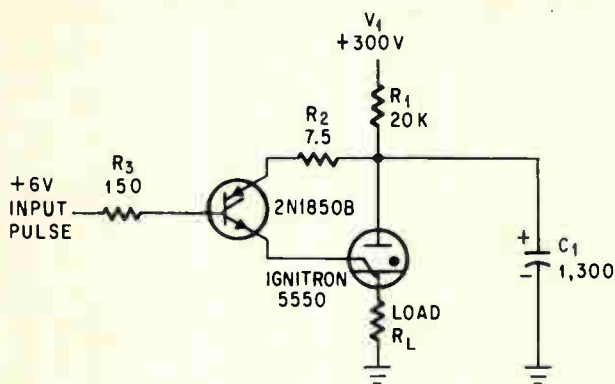

A Silicon controlled rectifier replaces a thyatron conventionally used to fire an ignitron.

The value of  $V_1/R_1$  should not exceed the SCR holding current (about 20 milliamperes for the 2N1850B) so that the silicon controlled rectifier will turn off when  $C_1$  discharges.

The SCR trigger pulse frequency should be less than  $1/5(R_1C_1)$  if the capacitor is to become fully charged to  $V_1$  before it is discharged. If the trigger pulse frequency used is greater than  $1/5(R_1C_1)$ , the current supplied to the load is reduced. While it is not necessary for  $C_1$  to become fully charged for the circuit to function, the charge should reach at least 80 volts. The voltage to which the capacitor will charge before being discharged by the trigger pulse is given by the expression:

$$V_{C1} = V_1 [1 - \exp(-1/R_1C_1f)]$$

where  $f$  is the trigger pulse frequency.

Resistor  $R_2$  is used to limit the SCR anode current to a safe value while allowing ample ignitor current supplied to the load is reduced. While it

The direction of current flow through  $R_L$  can be reversed by placing the load between  $C_1$  and ground and returning the ignitron cathode directly to ground.

The 2N1850B is available from Texas Instruments, Inc., and General Instrument Corp. The ignitron type 5550 is manufactured by RCA.

## Electronic timer provides long delay

By Herbert W. Hines and Leo C. Radzik

International Business Machines Corp., Endicott, New York

An economical circuit to provide a 13-second delay at the terminals of a data communications system was furnished by the circuit shown through the use of silicon semiconductor devices having low-leakage current ratings. A 10-millisecond positive-going pulse is used to trigger the circuit. Application of a 36-millisecond positive-going pulse halts

the timing action.

Before application of the 10-millisecond trigger pulse, the top of  $C_1$  is positively charged to +1 volt through  $R_2$  by the +12-volt battery. The positive voltage at the base of  $Q_1$  causes  $Q_1$  to conduct. The  $Q_1$  emitter current flows through  $D_2$  and  $D_3$  causing a small positive voltage drop across  $D_3$  which cuts off  $Q_2$ .

The start pulse is applied, closing reed relay  $K_1$ . The top of capacitor  $C_1$  is now charged through  $R_5$  to -12 volts. The negative-going ramp voltage at the base of  $Q_1$  turns  $Q_1$  off. The resultant negative-going voltage at the  $Q_1$  emitter reverse-biases  $D_2$ . Transistor  $Q_2$  is then turned on by the -12 volts, applied through  $R_1$  to its base.

At the end of the start pulse,  $K_1$  opens and the top of  $C_1$  charges, slowly, toward +12 volts. When the charge on  $C_1$  rises above +1 volt,  $Q_1$  becomes forward-biased and conducts, turning  $Q_2$  off. For the component values shown, the time during which  $Q_2$  conducts is 13 seconds.

The normal timing period can be interrupted at any time by applying a 36-millisecond pulse to the stop input  $K_2$ . This allows the bypassing of  $R_2$  by  $R_4$  so that the top of  $C_1$  will rapidly become positive enough to turn  $Q_1$  on.

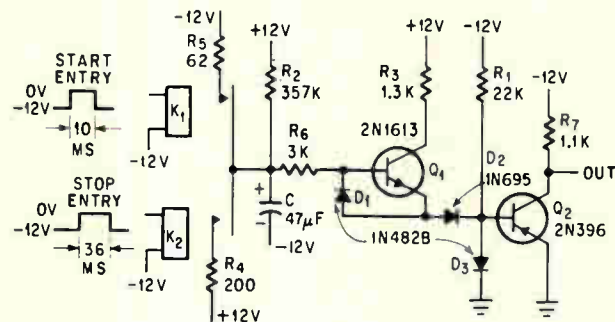

The timing period provided by this circuit was used in data communications equipment which switched automatically from the transmit mode to the receive mode 13 seconds after the operator finished sending.

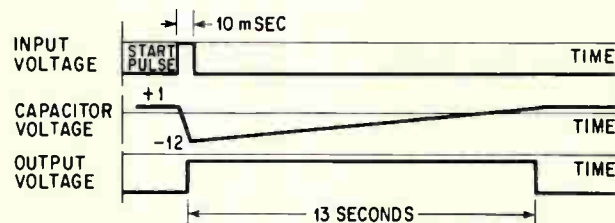

Waveforms for normal delay operation.

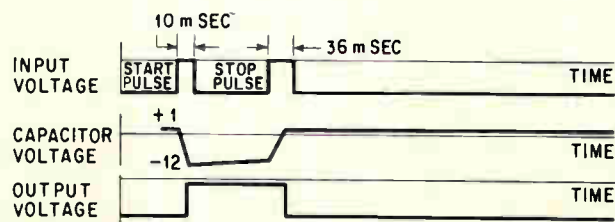

Waveforms for interrupted delay operation.

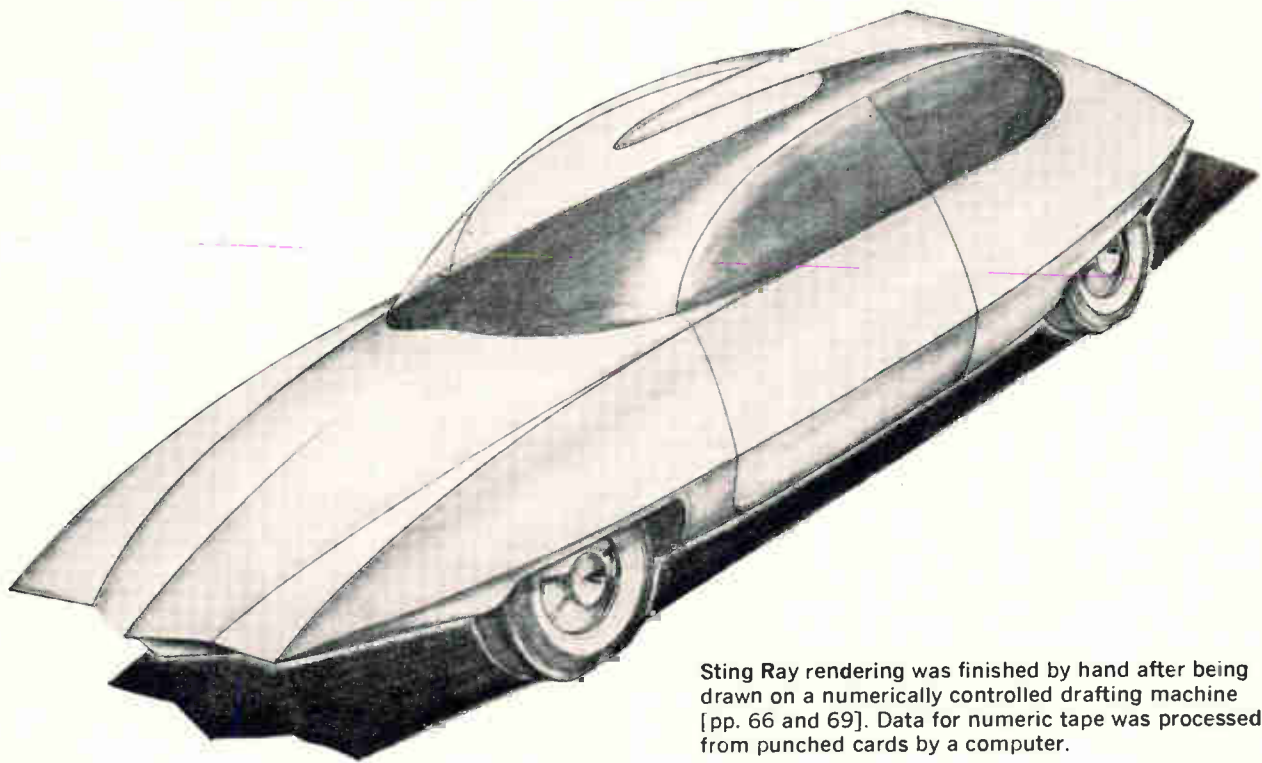

Sting Ray rendering was finished by hand after being drawn on a numerically controlled drafting machine [pp. 66 and 69]. Data for numeric tape was processed from punched cards by a computer.

**and faster**

**machine**

*Better design by ~~skilled stylists~~*

Electronic designers of cars use light-scanning machines, closed-circuit tv, computers and numerically controlled drafting machines

By Louis S. Gomolak  
Industrial Electronics Editor

**Automation**, already entrenched in offices and along assembly lines, is beginning to work its way into the drafting rooms where tomorrow's cars are being designed.

The electronic designer is a combination of computers, light-scanning—possibly laser—measure-

ment techniques, and numerically controlled drafting machines.

Used experimentally and in secret, it has produced in about 30 minutes some designs that normally take three months to complete.

A new car's journey from the stylist to the show-

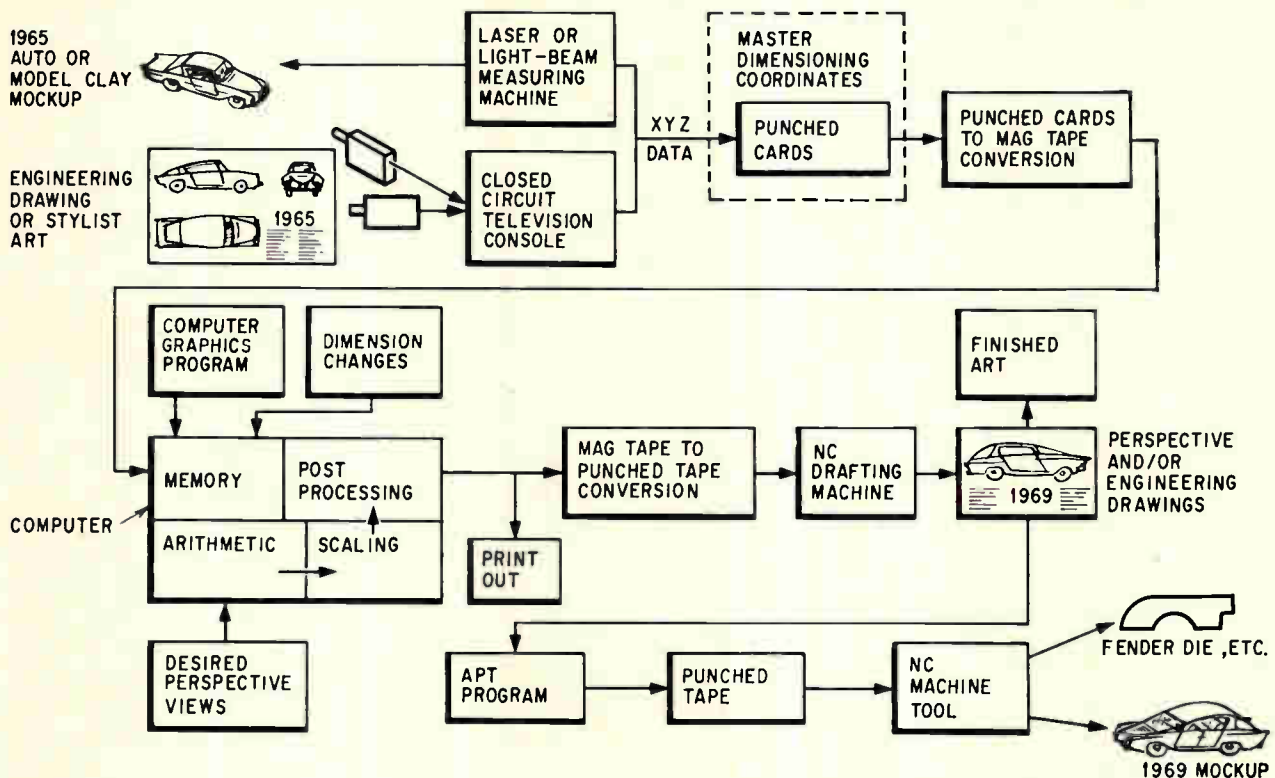

Laser measuring machine has been tested for finding the math model of objects. Ford's experiments include closed-circuit tv and a light-beam measuring machine. These are connected to a computer which turns out punched tape to run the numerically controlled drafting machine. Similar tapes may be used on numerically controlled die milling equipment or machine tools for production dies or mockup models of cars.

room usually takes three years. The auto industry wants to cut this lead time to one year or less, and at least one of the Big Three manufacturers expects to do it with the help of a technique called computer graphics, or automated styling.

### Styling the Sting Ray

In an experiment for the Chevrolet division of the General Motors Corp., the Boeing Co. used computer graphics last year to run off sketches of Chevy's Sting Ray (see sketches). But the equipment used is already said to be obsolete.

Proximity probes reportedly were used to measure the length, width and height of a clay mockup. These coordinates were then punched into cards and fed into a computer.

Punched tape was made and used to run a numerically controlled drafting machine, or engineering plotter, which produced the drawings shown on these pages. The drawings were then converted by hand into the finished Sting Ray sketch.

### In Ford's future, too

GM's closest competitor, the Ford Motor Co., also is known to have experimented with computer graphics. Detroit sources say Ford already has ordered at least a half-dozen of the latest numerically controlled drafting machines, and is reported to be ready to buy a computer graphics system, with exclusive rights to it in the auto industry.

Last February, and again late in April, Ford ran

off some drawings using computer graphics, essentially following a system similar to that shown above.

In one experiment, Ford is said to have created the mathematical model of a car, using a closed-circuit television system. Ford also is reported to be working with a light-scanning measurement system. Having both methods available, Ford can use flat drawings as a data source as well as three-dimensional models of cars.

Computer graphics requires a basic source on which to build. After the dimensions of a car are loaded into a computer, the style can be changed without the stylist having to do as much as lift a pencil. If he wants to extend the fenders a bit, or move the greenhouse (windows and roof) forward or back, he merely punches the instructions into a card and feeds it to the computer. The next drawing will have those changes.

### Measuring with tv

At its Dearborn, Mich., research center Ford is reported to have a remote-controlled, closed-circuit television system. An engineering drawing or stylist's rendering is placed on a table below a television camera that is mounted in a gantry. An operator, sitting between the tv monitor and the drawing, watches the drawing on the tv screen.

Using a joy-stick, he moves lighted cross-hairs across the tv image of a drawing. By pressing a button at every 0.125 inch or less, he records the

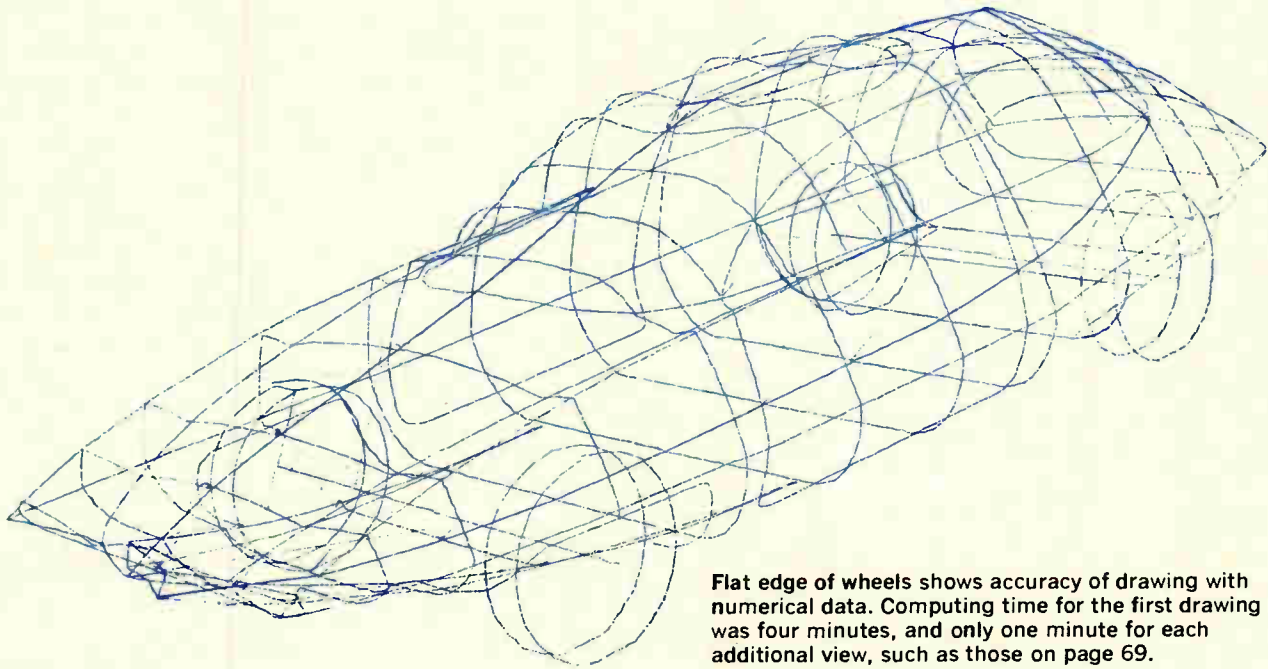

Flat edge of wheels shows accuracy of drawing with numerical data. Computing time for the first drawing was four minutes, and only one minute for each additional view, such as those on page 69.

coordinates of thousands of points on the drawing. In a side view of an auto, these points plot the height and length of the vehicle. These distances are processed, through the tv system, to a card-punch.

Width (Y) is obtained from the top view of the auto design. Additional Z data is found by scanning the front view.

When scanning is completed, a mathematical model of the car has been transferred into a deck of cards, called a source program. The perspective views are so accurate that the car's wheels are flat where they touch the ground (see drawing).

### Scanning with light

There is at least one other way to take coordinates for drawings. This involves scanning with light, much as radar scans with radio beams.

Ford is reported to be using a light-scanning measuring machine, built by the Ex-Cell-O Corp., to inspect clay mockups for X (length), Y (width) and Z (height) coordinates.

Mounted above another table is a fixed light source, aimed downward. The scanner is triggered in brief bursts, and the light is focused through a series of lenses.

Ranging circuits in the scanning machine measure the light's travel time, convert it into distance from the source, and feed the data into a card-punch.

Then a clay model is accurately positioned on the table. The table is moved by hand-cranks, with micrometer accuracy, until any desired point on the model is directly under the light source.

The beam is flashed and its return is detected by a photocell. This time the light has traveled less

time than when the table was bare. The time difference is converted into a height (Z) coordinate, which is used to activate the card-punch. Length (X) and width (Y) coordinates of each point are obtained from readouts attached to the hand-cranks, and are also punched into cards.

These cards also contain instructions for controlling, raising and lowering the plotter pen of a numerically controlled drafting machine.

### Numerically controlled laser

Ex-Cell-O is reluctant to discuss the future of its machine. One reason may be that the Ex-Cell-O design used by Ford is already obsolete. A laser inspector has been built with a resolution far greater than that of the Ex-Cell-O machine.

The laser machine operates almost identically to Ex-Cell-O's fixed scanner above a movable table. Because of its coherent beam and resolution, the laser probe closely approaches measuring with a true point. [For background on measuring probes, see *Electronics*, May 4, 1964, p. 79]. Reported accuracy of this new laser machine is 0.0001 inch in all three coordinates.

Although the laser machine is now hand-cranked in X and Y, there is speculation that a new model is planned, using some form of autoset for numerical control of the table movements. Autoset is a device using sensing servos, servo amplifiers and phase-sensitive circuitry to control the movements of numerically controlled machine tools and measuring probes. Modified somewhat, it could be used on the laser measurer.

The timing of the laser could also be programmed on tape. This would complete the automation of the process of collecting coordinates.

## Not as fast, but cheap

The closed-circuit tv and the light-beam scanner systems give Ford the ability to take coordinates from drawings or mockups of clay or wood. There is another, less expensive way.

According to Jack Moorhead, manager of John A. Moorhead Associates, "using an engineering plotter in reverse is also practical; it's fairly fast and cheap, and there are already enough plotters around." John A. Moorhead Associates is the industrial consultant firm that supplies computer graphics programming under agreement with an investment firm, Computer Graphics, Inc., which owns the technique.

The conventional engineering plotter is a table affair with movable crossbeams above it that hold and position a ballpoint pen. By replacing the pen with a probe, every time the probe stops over a point on the drawing the coordinates of that particular point, with respect to a reference or origin point, can be recorded. The process is slower than with numerical control, but still faster than using a tape measure or ruler. And it's a lot cheaper than using one of the new numerically controlled measuring machines.

In the Ford work, the source deck of punched cards was converted to magnetic tape on an IBM 1401 system, using a card-to-tape utility program. The tape was then loaded into a 7090 computer. The computer produced magnetic tape with the coordinates for the numerically controlled drafting machine. These were converted to punched tape and put on the drafting machine.

But this source program is only one of three major inputs, no matter which computing system is used.

## Perspective view

Collecting the math model of an auto is far simpler than the programming needed to turn that model into a perspective view of the auto. A perspective view is the product of two techniques, called master dimensioning and computer graphics, and a mathematical form of a wish known as desired view.

Master dimensioning is, basically, measuring the distance of all points on an object from one origin point. Computer graphics is a patent-pending technique that is basically a mathematical model of what a pair of human eyes sees. Desired view is what the stylist would like to see.

## Master dimensioning

Collecting the coordinates of a mockup, or building a mathematical model of the car, is only one part of master dimensioning. These coordinates form the source deck, the basic data needed to produce a perspective view.

Besides supplying the data needed for drawings, master dimensioning offers other features. Engineering and production information is stored in a digital computer memory, or on tape or in cards.

The computer can search for design data and even do much interpretation, allowing designers to do more designing.

These advantages result in uniform control of

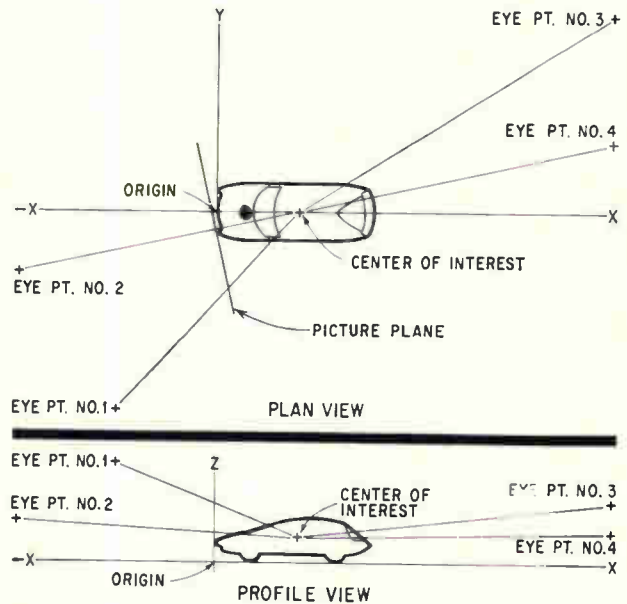

Line of vision must pass through some center of interest when looking at any object. The picture plane for eye point number 2 is where eye fixes on the car, the remainder of the car serving as a background.



Glamorous interiors must be carved by hand out of clay. With computer graphics, the stylist can change dimensions and designs and see his ideas on paper within 30-odd minutes.

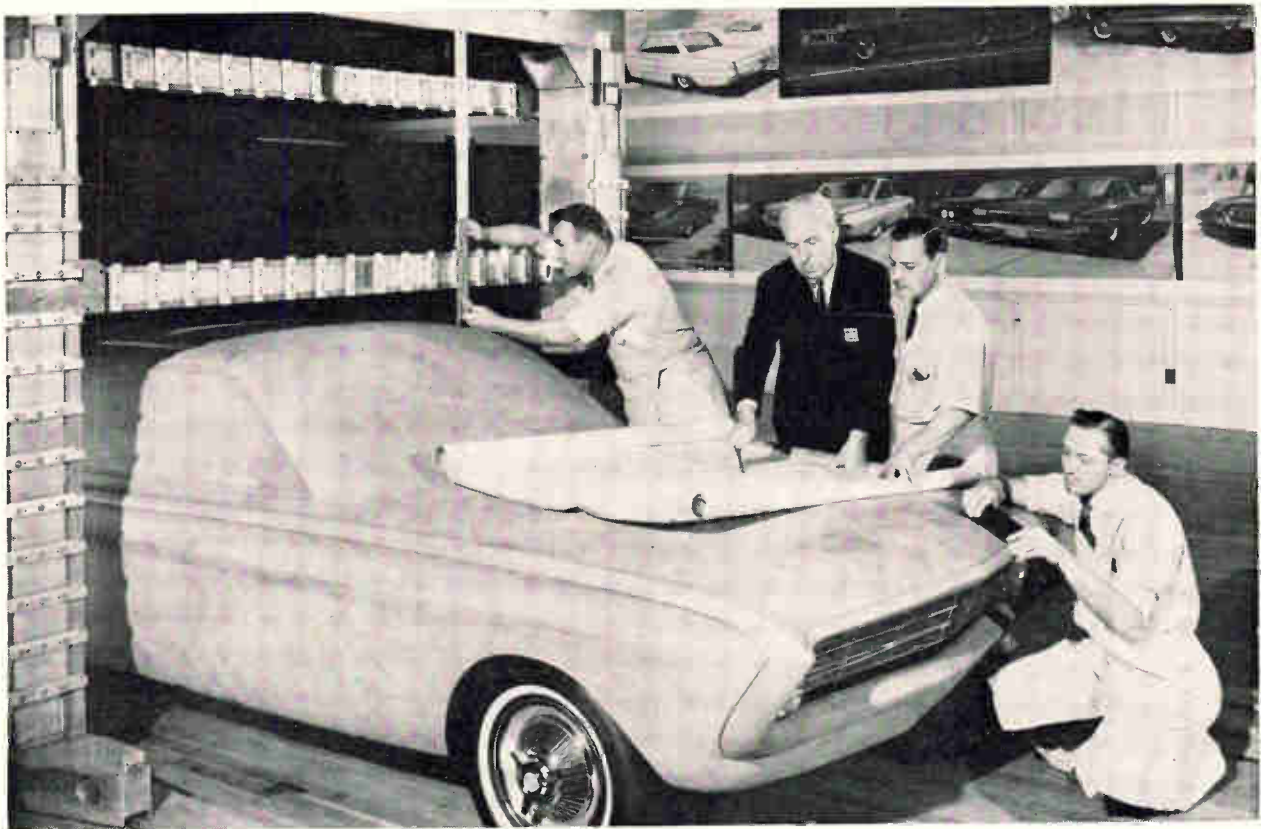

Measuring and scraping to make finished clay mockups takes weeks. In hours, using the tapes that controlled the drawings, scaled-down mockups or full-sized metal paneling could be run off on numerically controlled machine tools.

a part's dimensions, from conception to production. A direct line of communications connects the design with the production departments. Also, drafting is greatly simplified using the computer graphics program. And the latest in alterations will always be on hand, as they are fed into the computer at the time the changes take place.

Master dimensioning gives a computer the ability to derive math definitions of complex surfaces, and to combine many complex surfaces mathematically to produce a perspective view of an object.

These drawings require a minimum of two computer runs. One produces the math definitions of complex surfaces. The second generates the coordinates from these surfaces needed to run a numerically controlled drafting machine to draw perspective views.

Master dimensioning has been in fairly wide use for some time in the aviation industry. North American Aviation, Inc., is reported to have used master dimensioning in its design of the B-70 supersonic bomber. Boeing also used master dimensioning for perspective art on a new fighter aircraft. But Ford's is the first real application in the automotive field.

#### How it looks

After master dimensioning, the next thing to be stored in the memory is the computer graphics program. Computer graphics changes the input coordinates into perspective-view coordinates in the

same way that your eyes change the apparent dimensions of an object you are looking at. It's this principle that makes parallel railroad tracks seem to converge as they approach the horizon.

With this sight model stored in memory, the job of turning out drawings starts. The automotive styling can now say, "Let me see what the 1965 Mustang, which we just measured for coordinates, will look like coming up the road, a block away, viewed from atop a five-story building."

This order is translated into three coordinates giving the location of the eyes in space, three more coordinates specifying the center of interest, and a number that tells which picture plane is desired (diagram at top of p. 67). The center of interest and the picture plane define the angle at which the car is viewed and the part of the car that is in sharpest focus. This "visual" information is punched into an IBM card.

About 30 minutes after the card is fed into the computer, a perspective drawing like that on page 66 will be completed.

But drawings of existing autos are as stale as yesterday's news. Designers are interested in 1967, '68 and '69 models.

#### Different views

Using the 1965 models as a starting point, the designer inserts still another piece of information into the computer. Looking at this year's car, he says, "Let's see what it would look like if the body

Standing in front and to the right of the auto. This is all an experienced designer needs for mind's eye views.

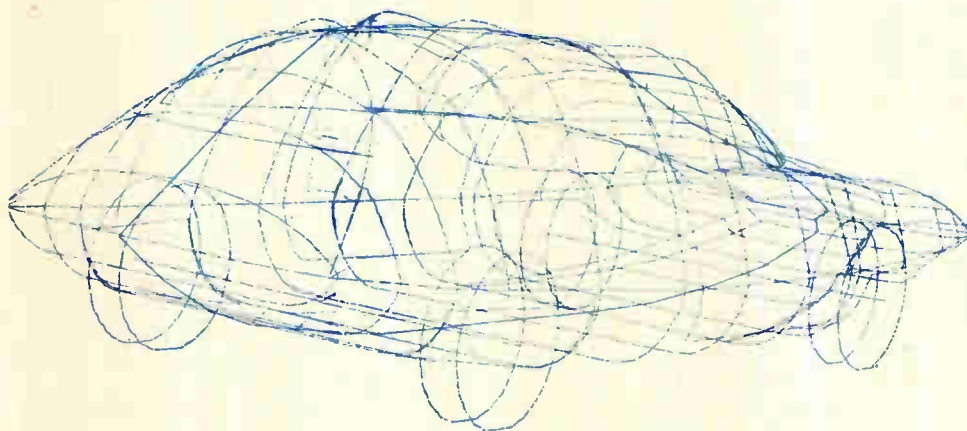
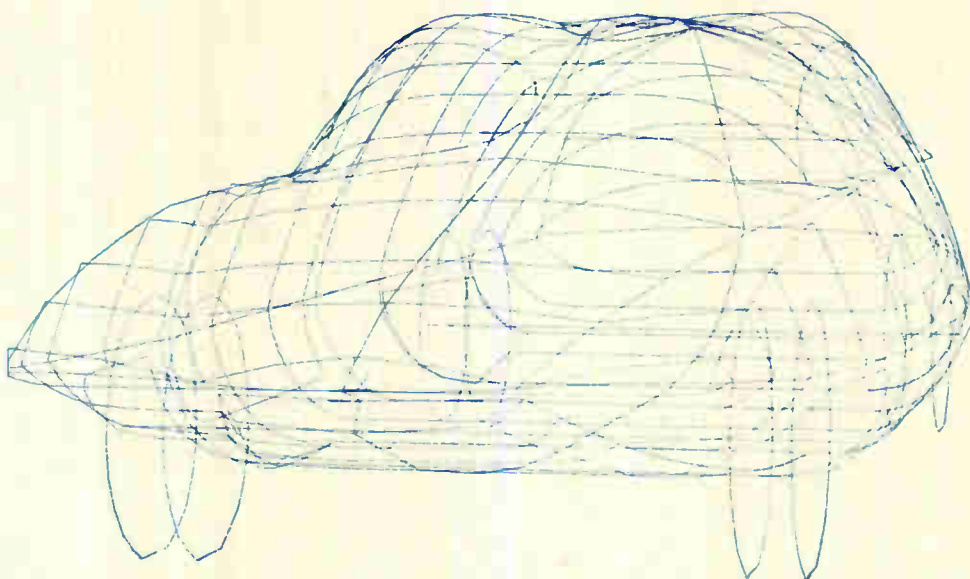

Moving away from observer, the Sting Ray would look like this.

were two inches longer, the greenhouse an inch lower, and the fenders wrapped around an additional three inches." This information, in almost this exact language, is punched into cards or put on magnetic tape and loaded into the computer. It changes the basic master dimensioning data that is already in the memory.

According to Moorhead, "We can program the computer to recognize words familiar to designers; they don't need a new language to talk to the computer."

Since the graphics program is in FORTRAN—FORMula TRANslation format—it can be used on any number of computers, such as the 7090, 1620, 1410 and 1401. It has been run on each of these. It also fits any system made by the Radio Corp. of America, National Cash Register Co., Burroughs Corp. or Control Data Corp.

When the stylist tells the computer what view he wants, the computer takes the modified master

dimensioning data, combines it with the graphics program and comes up with the coordinates needed for the perspective drawing.

This data is scaled to fit the plot size of the numerically controlled drafting machine. The data is then post-processed, or put into a form (word address, binary coded decimal) required by the drafting machine's control system.

#### Instant drawings

Computing time for the first view is about four minutes, and with almost any type of drafting machine a drawing takes about 30 minutes. For each additional view using the same dimensions, the computing time is only one minute.

Almost any part of the car can be changed, except the greenhouse. Detroit likes to keep a continuity from year to year, and tries for four-year runs. With this constant, a stylist can now change an entire body design and see his brainchild on

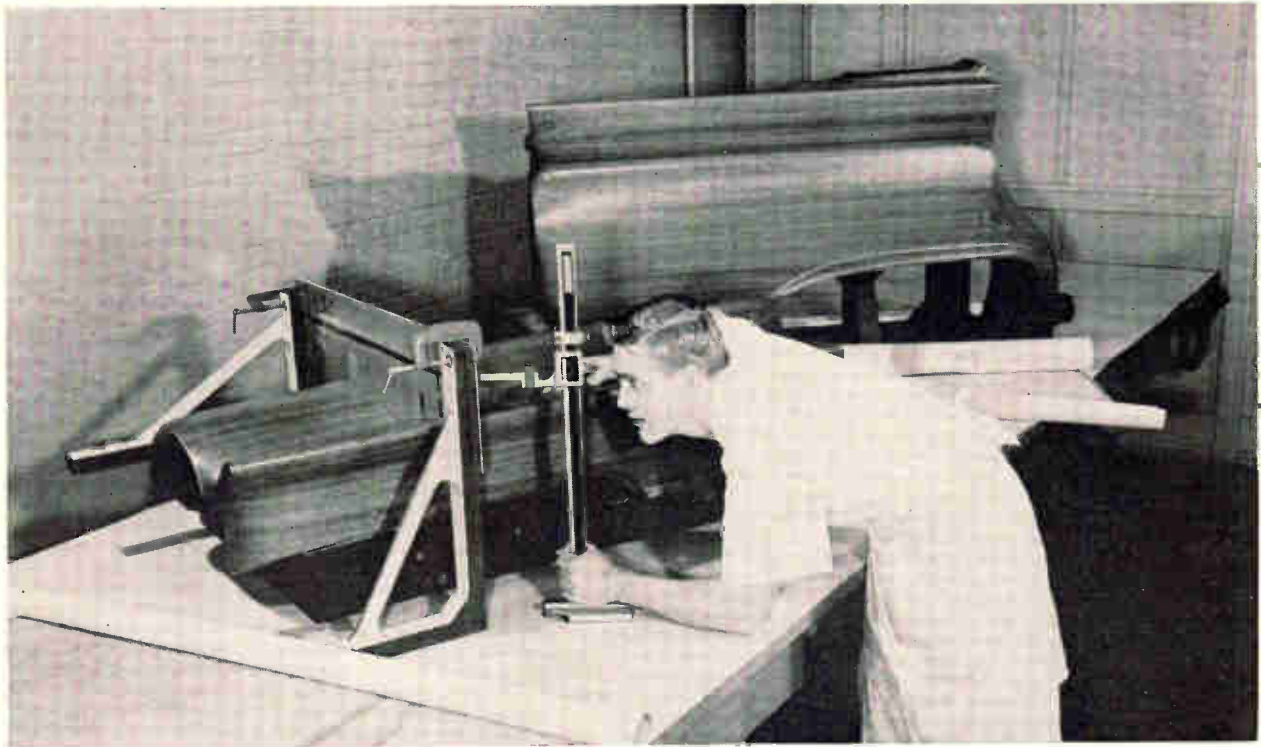

After clay, what? Wood carvers spend weeks carving accurate mahogany exterior quarter panels and other parts. These are used for templates to make production dies. The same process takes only a few hours with tape control.

paper within half an hour. Similar hand-drawn views would take at least several days.

The process is not limited to exteriors. By running the closed-circuit tv system over drawings, or an actual lash-up of last year's interiors, the stylist can rearrange the basic math model. New dashboards can be styled from old; even trunks can be reworked. All that is needed is a separate deck of source information for the different portions of the car.

There are also full-scale drawings from which templates are made for production dies [Electronics, May 4, 1964, p. 102]. These full-size drawings are also the source for the dimensions of the big clay models upon which management bases its final decision on what style to produce for any particular year.

There are drafting machines that can handle this size paper and the drawing, which now can take up to three months to finish, would take "about 46 minutes," Moorhead says. According to Detroit sources, Ford ran such huge drawings off in late April, on a small plotter. The drawing was made in three sections, which were later fitted together.

The plotter used for drawings in the Chevrolet experiments was an EAI Data Plotter. If the spacing between points on the drawing is 0.125 inch, the plotting speed is at least 350 points per minute from low-density magnetic tape. This machine is capable of plotting over a surface 28 inches square.

#### Movies next?

Motion pictures are a natural extension of the

computer graphics program. Because the computer can turn out a large number of drawings in a short time, highly accurate animated movies are practical. Walt Disney is rumored to be interested in computer graphics as a means of making accurate backgrounds for his mice and poodles.

Movies have already been made of rocket flights; the changing attitude of the rocket in flight, as telemetered back to earth, was used as the dimension-changing information.

To completely automate the movie process, one experiment used a General Dynamics/Electronics SC-4020 cathode-ray tube as an electronics draftsman. This tube, with its associated circuitry, was connected directly to the computer. The different drawings were projected electronically on the face of the tube. The time of each projection was 0.035 second. These projections were then recorded on film.

Two important conclusions emerged from this experiment. Whereas the computer graphics program is too fast when using numerically controlled plotters or drafting machines, the program is too slow with electronic projection. According to Moorhead, the program is being refined to match electronic drafting speed.

The other conclusion was that for each minute of movie time, about six minutes of computing time on an IBM 7090 is needed. This gives some indication of cost.

One advantage of computer graphics is that the user doesn't need his own computer. After buying the graphics program and obtaining source decks,



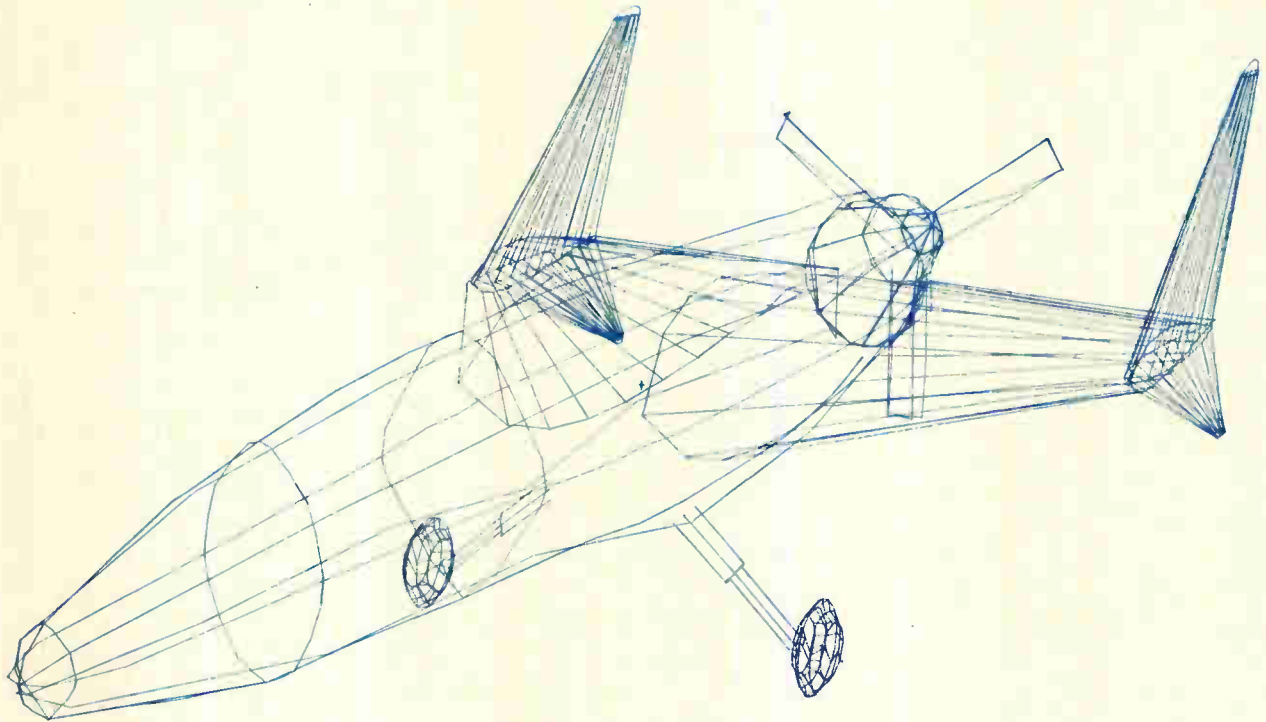

**Fighter aircraft** drawn by the Boeing Co. during preliminary design stage. One of many designs for a tactical fighter, this version was later dropped.

the user then needs only rent the computer time he needs to run off punched tapes to control his automatic plotters or drafting machines.

### **Mockups or dies**

From the computer art two steps are possible. Hand-finished drawings can be made, as with the Sting Ray. Or the drawing can be used to produce the directions to numerically control machine tools.

The operation would run something like this. Once the stylists and management have decided upon a drawing, or a number of models they like, they could command the computer to run-off a tape with the coordinates that would produce a scaled-down mockup in wood or aluminum. The coordinates would be converted, through the automatically programmed tool (APT) program, into punched tape to run a numerically controlled boring mill.

Using APT language, a programmer would convert the numerically controlled drafting art into coordinates that would describe the cutting path a tool must take to turn out a model of the desired size. A model could be produced in minutes, far more accurate than those that now require weeks.

"If management still wants to have a full-size mockup," says Moorhead, "we'll make the NC (numerical control) tape to produce tin or aluminum quarter panels and so on. They can take an old chassis and fit the panels on, and even drive the buggy around if they wish. Once those final coordinates are in the computer it doesn't matter what's done with them. The computer, through the

drafting machine and the APT program, can produce anything that can be machined."

When the final design decision has been made, these same coordinates can be used to produce drawings from which are made templates for new dies. "You can even eliminate these drawings," according to Moorhead. "The APT programmer just makes another tape, for the die-sinking machines."

With this technique, which Moorhead says is possible with existing equipment, advanced die-milling machines with electro-mechanical or photo-electric tracers would no longer be needed.

Using these same coordinates, the quality control and inspection departments could get into the act. The same coordinates needed for the dies could be used to control numerically driven measuring machines. This quality control, effective throughout the manufacturing phase of an operation, would have begun with design.

### **Bridges and washers**

Detroit's automakers are not the only people interested in computer graphics. A noted architect is experimenting with the technique for designing apartment houses, office complexes and ideal communities. A major bridge builder is also looking at drafting machines. And one of the leading makers of home appliances plans to use the graphics program for selecting models, along with numerically controlled machining to turn out washers, dryers and refrigerators.

If computer graphics breaks through in Detroit, there's no telling where it may go.

# Getting transistors into single-sideband amplifiers

A dual npn stage produces 30 peak watts in a smaller, lighter, cooler package than an electron-tube transmitter requires

By Roy C. Hejhall

Applications Engineer, Motorola Semiconductor Products, Inc., Phoenix, Ariz.

**The technical roadblocks** to employing transistors in linear power amplifiers have been removed with the construction of a 30-peak-watt single-sideband transmitter operating at 30 megacycles.

Transistors have been designed into small signal amplifiers for years. But it has not been possible to design high-power amplifiers with the linearity characteristics required for single-sideband application. Now two innovations make it possible: new higher-power transistors and a new approach to circuit design.

Probably the key to the solution is careful attention to circuit design and adjustment. The amplifiers built have a pi-network output tank, and the parallel-connected npn output transistors have been properly biased.

In general, power amplifiers in radio transmitters can be divided into two categories: those which must be linear, and those which do not have to be. If the stage amplifies only a single r-f frequency, it usually does not require a high degree of linearity. On the other hand, if any intelligence is superimposed on the radio-frequency carrier that must be amplified, then the stage generally must be linear.

The techniques described in this article are applicable to any power amplifier in the latter category, whether it be single sideband, modulated c-w, a-m where low-level modulation is applied before the power amplifier stages, or data transmission.

Since efficiency is also important, the design represents a compromise. Although the attainment of linearity was paramount, efficiency also had to be considered. For example, a Class A amplifier is an example of a linear amplifier with a complete sacrifice of efficiency.

Respectable power output, in the order of 50 watts, has recently been attained at high frequencies using improved silicon transistors. However, such output stages are operated in a class C mode in which output efficiency is high, particularly in amplifying conventional narrow-band signals characterized by amplitude- and frequency-modulation voice communications.

For broad-band amplification in which the output signal must bear an exact resemblance to the input, the linear class B mode is required. In this mode, the operating point of the transistor characteristic is chosen for highest possible efficiency commensurate with the achievement of good linearity. Appreciable output power has now been obtained, making available an all-transistor single-sideband transmitter<sup>1,2</sup> commercially competitive with a low-power electron-tube equipment but lighter, smaller, requiring less operating power and producing less heat.

Since the circuit drawing of a class B transistor amplifier appears similar to that of the class C in general use, the development of the new equipment is described in terms of an existing class C amplifier.

## Class C amplifier

The circuit (p. 73, right) for a 50-megacycle class C power amplifier uses two 2N2947 npn silicon transistors in parallel. This amplifier delivers 40 watts of r-f power to a 50-ohm load with a power gain of seven decibels.

The output circuit is a tapped network. Both input and output are connected to taps on L<sub>2</sub>, permitting the tank circuit to attain a higher loaded Q. The input network for the amplifier provides

Typical amplifier delivers 40 watts at 50 Mc when it operates under class C conditions. ▶

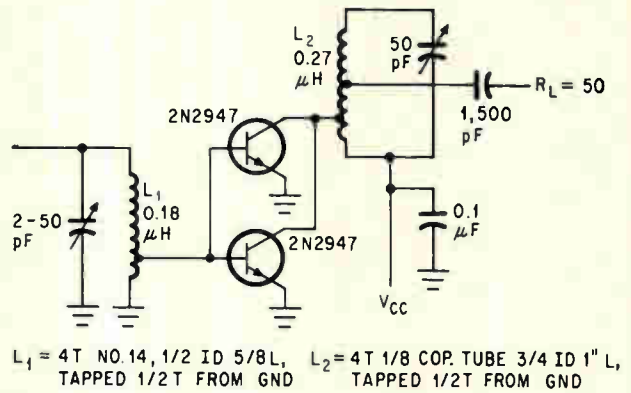
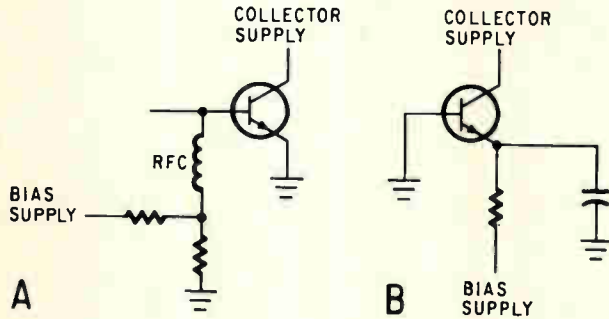

$L_1 = 4\text{ T NO. 14, } 1/2\text{ ID } 5/8\text{L, } L_2 = 4\text{ T } 1/8\text{ COP. TUBE } 3/4\text{ ID } 1''\text{ L, TAPPED } 1/2\text{ T FROM GND}$

Bias circuits, employing resistive divider (A) in base circuit or with base grounded and bias in emitter circuit (B)

the required impedance matching.

The d-c bias arrangement in this circuit is typical for class C power amplifiers with transistors. There is no forward bias as there is in small-signal amplifiers. The only direct voltage applied to the stage is the collector supply.

The transistors are biased on by the incoming r-f signal. With no signal input they do not conduct. Average d-c collector currents are dependent upon input signal amplitude. If the driving signal is removed, the transistors stop conducting and there is no danger of damage as there is in electron-tube amplifiers.

### Single-sideband amplifiers

The most important additional requirement placed on r-f power amplifiers for single-sideband service is linearity. It is helpful here to consider the reasons for this added requirement.

In a c-w, a-m or f-m transmitter, the output stage is usually operated class C for best efficiency. The input signal to the output stage at any instant consists of only a single frequency. A transistor operating class C is nonlinear, but with a single frequency input only the fundamental frequency and its harmonics will appear in the output.

This behavior is convenient, since in the high-frequency spectrum harmonics are far removed from the fundamental frequency and are attenuated by tuned-circuit techniques. A primary design characteristic of the output circuit in a class C power amplifier is that it must have a loaded Q high

enough to attenuate undesired harmonics. Thus, although spurious signals are generated in the stage, the signal delivered to the antenna is reasonably free of distortion.

In a single-sideband transmitter, each audio-frequency input results in a radio-frequency output to the antenna at a frequency that differs from the suppressed r-f carrier frequency by an amount equal to the audio input frequency. Since a speech input contains many different audio frequencies at any given instant, the input to the r-f power amplifier at any instant comprises many radio frequencies, all within audio frequency spacing of the suppressed r-f carrier. Under these conditions, third and higher odd-order distortion in the amplifier will result in spurious outputs with frequencies near that of the desired output signal.

The practical result of this situation is an increase in the signal bandwidth owing to the presence of spurious outputs adjacent to the desired channel.

Harmonics are also present, but these can be attenuated sufficiently by the output circuit as in the class C amplifier. However, the odd-order distortion products are so close to the frequency of the desired signal that it is impossible to reduce them with practical tuned circuits. The only solution, therefore, is to attempt to improve the linearity of the distortion-producing element, which in this case is the transistor.

The linearity of a single-sideband power amplifier is usually measured by injecting a test signal

### Performance data of 30-Mc linear amplifier

Power output, watts, pep	3rd order distortion products, db	5th order distortion products, db	Power gain, db	Collector efficiency	Supply voltage, volts, d-c
15	-32	-37	12	52%	30
30	-22	-37	9.6	51%	30

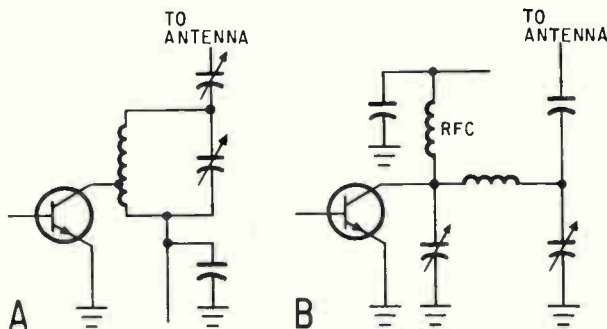

**Representative 30-Mc amplifier that delivers 15 to 20 watts of peak envelope power. Output can be pushed to 30 watts but the power ratio of signal to odd-order distortion products rises from minus 30 to minus 22 decibels.▶**

Output circuits, employing a tapped network (A) and pi network (B)

comprising two different audio signals and observing the resulting output signal on a high-resolution spectrum analyzer. Distortion products appear as signals adjacent to the desired signals, and the analyzer is calibrated to show the relative magnitudes of the desired signals and undesired distortion products. This measurement is called a two-tone test,<sup>3,4</sup> and the linearity of an amplifier is expressed in decibels as a power ratio of signal-to-distortion products.

### Why class B

In achieving linearity for single-sideband service, some known techniques were considered for the final prototype.

Class A operation is not practical because the very low efficiencies obtained with this mode would require excessive power supply and transistor dissipation requirements. A possible problem with class B operation is nonlinear loading of the preceding stage, owing to operation of the base-emitter junction near the most nonlinear region of its forward characteristics.

The problem of loading a nonlinear input circuit is often solved in electron-tube amplifiers by shunting the grid circuit with a fixed resistance that may be as much as one order of magnitude lower than the input resistance of the tube. However, this technique is not practical in designing a transmitter using transistors, because of the resulting drastic reduction in power gain.

Another common way to improve the linearity of electron-tube amplifiers is through the use of feedback. This is also not practical in transistor

transmitters, since in most cases the improvement in linearity will not justify the resulting reduction in power gain.

It appears, therefore, that the transistor linear amplifier should be operated class B for best efficiency and must rely primarily on correct bias conditions for proper operation. Resistive loading of the input circuit and the use of feedback are not feasible.

### Bias conditions

The most significant consideration for linearity is d-c bias. The transistor is forward-biased with a small collector current when no r-f signal is applied. Typical no-signal collector currents range from 2 to 10 milliamperes.

The type of bias circuit is also important. One method of obtaining the required forward bias is through the use of a resistive divider in the base circuit, as shown at A (above).

The values of the divider resistors affect both linearity and collector efficiency. This fact can be understood by considering that the base-emitter diode rectifies the r-f signal and charges any capacitance in the base circuit. The polarity of this charge tends to bias the transistor off. Therefore, if sufficient average d-c voltage is developed in this manner, operation becomes class C at high power levels, resulting in higher efficiency and a considerable increase in distortion.

Usually the controlling factor in bias circuit design is linearity, and the bias circuit must be adjusted for best linear performance with reasonable efficiency.

The impedance of the bias network determines the average d-c base voltage. A fairly stiff bias voltage must be used; bias circuit impedances of less than 100 ohms are used with amplifiers in the 20-watt class.

Another method of obtaining the required bias is to connect the base to d-c ground and to connect a bias supply in the emitter circuit as shown at B (above).

### Output methods

Output circuits are also important. Both the type

### Author



Roy Hejhall, a graduate of the United States Naval Academy, has been working on transistor circuit design and evaluation since 1961 at the Semiconductor Products division of Motorola, Inc.

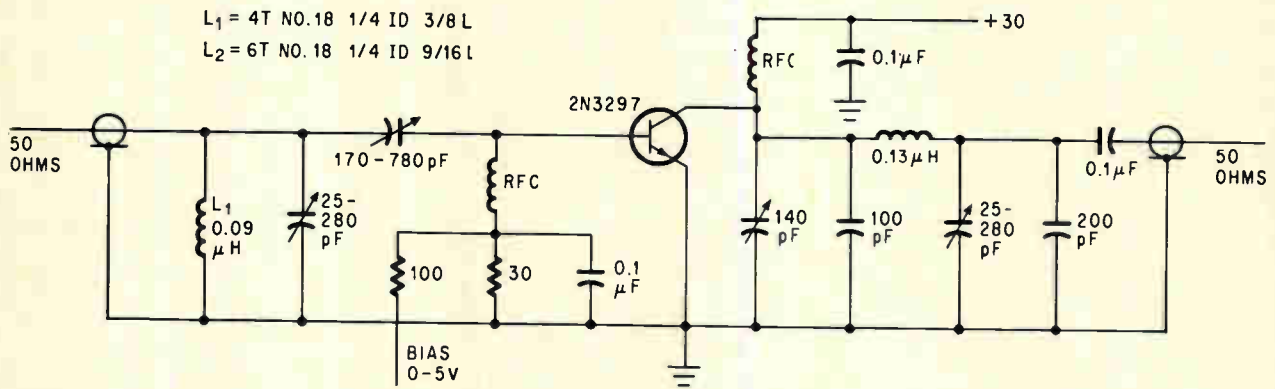

of output circuit and the tuning procedures affect linearity. Variations of a tapped network A (above) and the pi network B have been tried. Considerably better linearity is obtained with the pi network. Changing from a tapped network to a pi network improved the signal-to-distortion ratio as much as five decibels.

### Tuning and linearity

The effect of tuning on linearity primarily concerns the collector load resistance. In general, reducing this resistance improves linearity. In a pi network, the output capacitor varies the collector load and the input capacitor tunes the network. It has been found that decreasing the collector load to slightly below the value required for maximum power output, and tuning for resonance, improved the signal-to-distortion ratio with only a negligible loss of output power.

This discovery has resulted in a procedure for tuning the output circuit that consists of adjusting both capacitors for maximum power output, then decreasing the output capacitance slightly to the point where a decrease in power output is barely noticeable, and returning the input capacitance for maximum power output. The output circuit must also perform the usual functions of impedance transformation and harmonic attenuation.

The input circuit has much less effect on linearity than the output circuit. Wide variations in tuning,  $Q$ , and source impedance were tried with almost negligible effect on linearity. Therefore, the input circuit of the power amplifier may generally be designed to satisfy other requirements, such as impedance matching and desired bandwidth.

### 30-Mc amplifier

The 30-megacycle amplifier shown above is capable of delivering 15 to 20 watts of peak envelope power r-f output, with all odd-order distortion products at least 30 decibels below the desired signal in a two-tone single-sideband test. The transistor is a 2N3297 npn silicon unit in a TO-3 (diamond) package.

The input circuit is a tapped network for which the primary function is impedance matching for

maximum power transfer. The output circuit is a pi network.

The transistor is bolted to the chassis for heat-sinking. Two mica spacers isolate the collector electrically while providing the required thermal conductivity. Two spacers are used instead of one to reduce the capacitance between the chassis and the collector, which is electrically connected to the transistor package. Total output capacitance of the 2N3297 with two spacers is about 100 picofarads, and the output circuit is designed to operate with this input capacitance in parallel with C6 and C7.

The forward bias required for linearity is supplied by the bias source in the base circuit. The impedance of the bias divider is selected for the best combination of linearity and collector efficiency. Collector current is five milliamperes with no signal at the input.

The performance data for this circuit is given in the table. More power output can be obtained at the expense of linearity. As shown, power output can be increased to 30 watts pep, but in doing so the signal-to-distortion ratio is reduced to 22 decibels. However, in applications where this ratio is sufficient, the amplifier can be operated at 30 watts peak envelope power output.

Power output can also be increased by connecting additional transistors in parallel. However, the push-pull configuration has not been tried, owing to the difficulty in obtaining well-balanced, out-of-phase driving signals.

The techniques described here are applicable not only to single-sideband but to any communications transmitter in which intelligence is imposed on the r-f carrier prior to the power-amplifier stages.

### Bibliography

1. Warren B. Bruene, Principles and Techniques of Single-Sideband Modulation, Electro-Technology, July 1962.
2. J.F. Honey and D.K. Weaver, An Introduction to Single-Sideband Communications, Proc IRE, Dec. 1956.
3. P.J. Icenbice and H.E. Fellhauer, Linearity Testing Techniques for Sideband Equipment, Proc IRE, Dec. 1956.
4. William I. Orr, Intermodulation Distortion in Linear Amplifiers, QST, Sept. 1963.

# Solid-state transmitter ready for uhf telemetry

Improved high-frequency transistors and varactor techniques add up to a 3-watt signal for new telemetering band

By Neville Downs and B. van Sutphin

Electronic Communications, Inc., St. Petersburg, Fla.

**Signals telemetered** from ordnance missiles and aircraft will soon have to be transmitted back to ground receivers on much higher radio frequencies than those currently in use. Although the cutoff date for present frequencies is the end of 1969, some ranges will be ready to pick up the new ultrahigh frequency signals this year and are expected to be fully operational by the fall of 1965.

Besides the need for new antennas, feed systems and receivers, the frequency shift from 216-260 megacycles to 2,200-2,300 megacycles will create a demand for effective transmitters requiring no more space, weight or power than those now in use. Although there are actually two new bands available—L band covering 1,435 to 1,535 Mc as well as S band from 2,200 to 2,300 Mc—there is more developmental activity in the latter band. The band is also considered more suitable for space work since this frequency range appears to experience a lower level of galactic noise. For these reasons, a three-watt, solid-state transmitter operating in the 2.2- to 2.3-gigacycle range has been developed by Electronic Communications, Inc.

The transmitter is constructed in modular form, making it possible to mount the equipment in several ways. Cooling is achieved by thermal conduction through the module case to a heat sink or to any metal surface that will remove heat adequately.

The transmitter accommodates a wide variety of modulating signal inputs, and may be operated from either d-c or a-c primary sources without sup-

plemental power supply modules. This mechanical and electrical versatility makes the unit suitable for any portable telemetry system.

The block diagram is also a modular diagram of the transmitter. Notations show the signal progression through the transmitter and indicate the power levels at each point. Decoupling networks and integral filters throughout the transmitter circuit maintain spurious output at least 60 decibels below the level of the output signal.

## F-m modulator

In the modulator semischematic diagram, transistor  $Q_1$  and its associated components make up the basic 24-megacycle oscillator. Frequency modulation is accomplished by coupling the modulating signal to the varactor diode that is in the frequency-determining circuit of the oscillator. The varactor exhibits nonlinear capacitance variation when the reverse bias applied to it changes.

Two voltages are applied to the varactor diode: a d-c bias voltage and the a-c modulating signal. The d-c bias sets the operating point of the varactor, and the a-c modulating signal produces the desired instantaneous capacitance variation. To achieve a linear relationship between the applied modulating signal and the resulting frequency deviation, the fundamentally nonlinear characteristics of the varactor diode must be compensated.

The required compensation is accomplished by adjusting the fixed bias applied to the varactor



Modular construction of the new uhf telemeter transmitter. Frequency and power outputs for each stage show the loss of power in tripling.

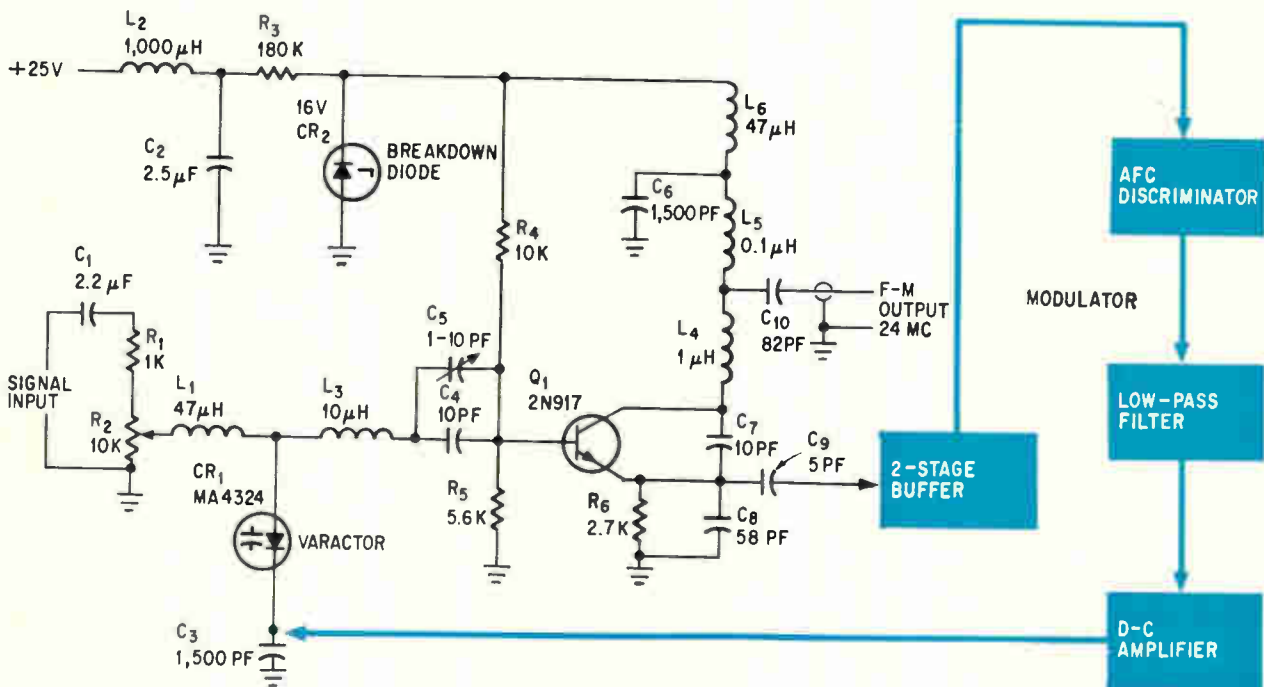

Varactor, used for short-term frequency shifts in modulation, is stabilized by feedback loop.

### Telemetry bands

Frequency range: 216-260 Megacycles (216-225 Mc channel assignments on basis of noninterference with established users)

- Channel separation, 500 kc
- Maximum deviation,  $\pm 125$  kc
- Frequency tolerance, 0.01%
- Maximum power, 100 watts

Frequency range: 1,435-1,535 Megacycles (1,435-1,485 Mc channels reserved for aeronautical flight testing of manned aircraft; 1,486-1,535 Mc channels reserved for aeronautical flight testing of missiles and space vehicles)

- Channel separation, 1 Mc
- Maximum deviation,  $\pm 125$  kc (narrow-band signals);  $\pm 1.4$  Mc (wide-band signals)
- Frequency tolerance, 0.005%
- Maximum power, minimum necessary to establish and maintain communications

Frequency range: 2,200-2,300 Megacycles

- Channel separation, 1 Mc
- Maximum deviation,  $\pm 125$  kc (narrow-band signals);  $\pm 1.4$  Mc (wide-band signals)
- Frequency tolerance, 0.005%
- Maximum power, Minimum necessary to establish and maintain communications



Neville Downs and B.W. Patton, who developed the new telemetering transmitter, examine typical modules.

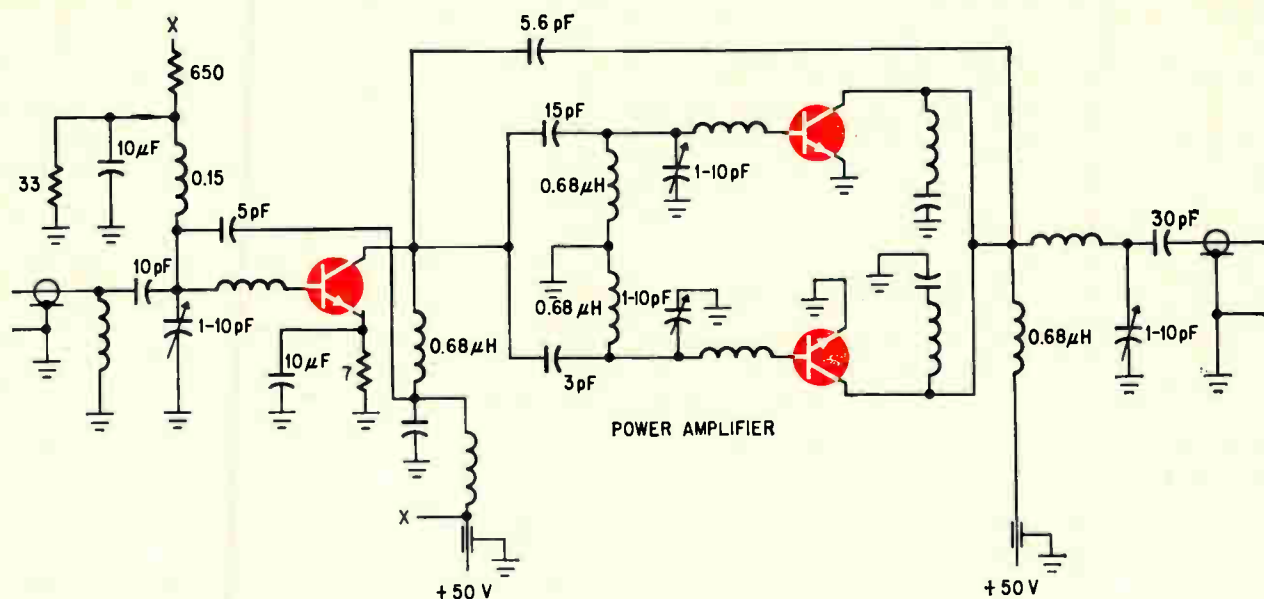

Power amplifier comprises class C transistor amplifiers

diode, and by adjusting the tuned circuits connected to the base and to the collector of the transistor to slightly different frequencies. Through adjustment, linearity of 2% can be achieved for frequency deviation of  $\pm 60$  kilocycles from the 24-Mc center frequency, and linearity of 0.5% for frequency deviation of  $\pm 10$  kc from the 24-Mc center frequency. Maximum deviation sensitivity is approximately  $\pm 75$  kc per volt root mean square, measured at the final output frequency, and is adjustable by variable resistor  $R_2$ .

The frequency deviation produced in the modulator is multiplied by 27 in the succeeding transmitter stages. At the transmitter output, the deviation capability at 2% distortion is greater than  $\pm 1.5$  Mc, and at 0.5% distortion it is greater than  $\pm 250$  kc.

The f-m output signal is obtained from the collector circuit of the oscillator. A signal obtained from the emitter circuit of the oscillator is fed through two buffer stages that are part of the automatic frequency control (afc) loop. The remainder of the loop consists of the afc discriminator, a low-pass filter and a d-c amplifier. The error signal from this loop is applied as corrective bias to the varactor diode in the oscillator circuit. Circuit constants are chosen to prevent interference with normal f-m operation of the circuit, and to remove long-term frequency variations that represent drift.

### R-f generator

A local oscillator, balanced mixer, two-stage buffer, frequency tripler and three intermediate power-amplifier stages comprise the radio-frequency generator shown as a block diagram.

The crystal-controlled local oscillator is a common-base Colpitts type with the crystal operating in the series mode. The oscillator frequency is

chosen well above the mixer output frequency to reduce spurious radiation. A parallel-resonant tank circuit assures oscillator operation in the proper crystal mode.

Further reduction of spurious radiation is achieved by using a balanced-diode mixer that cancels the local oscillator signal at the mixer output. Over-all frequency stability is improved by setting the mixer output frequency considerably higher than the modulator signal frequency. The mixer output is amplified to the 45-milliwatt level by the buffer stage and then applied to the frequency tripler.

The frequency tripler is a common-base stage operating class C for efficient harmonic generation. The tripler gives 25 milliwatts of output at the third harmonic frequency and provides 40 decibels of attenuation at the fundamental input signal frequency.

The last three stages of the r-f generator comprise a cascaded intermediate power amplifier. Each common-emitter stage has a gain of 4 to 6 db. Total gain of the three stages in cascade is 12 to 18 db. Total power output to a 50-ohm coaxial cable is 750 milliwatts in the frequency range from 244 to 256 Mc.

### Power amplifier

The power module shown in the schematic consists of a driver and a power amplifier using two transistors connected in parallel. Common-emitter circuits operating class C are used throughout. The original design required variable capacitors in the emitter circuit of each stage to tune out the inductance of the transistor itself, but improved high-frequency transistors currently available make this provision unnecessary.

Variable capacitors in the base circuits of the two parallel stages permit balancing the two cir-



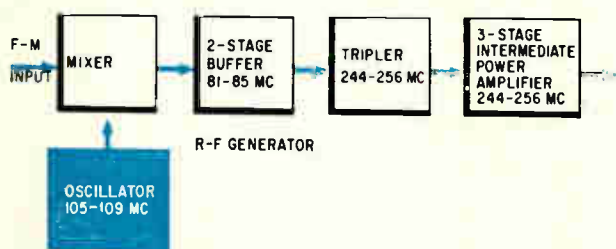

Radio-frequency generator uses a high-frequency oscillator to reduce spurious components in the final output.

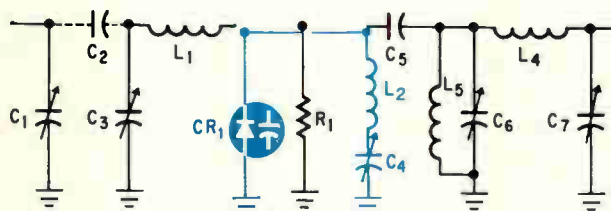

First frequency tripler using a varactor employs three parallel circuits to reduce unwanted spurious output. Second-harmonic trap is shown in color.

cuits. This adjustment is important to achieve high collector efficiency and maximum power output.

Total gain of the power amplifier is approximately 12 decibels. Total power output to a 50-ohm coaxial cable is 12 watts in the frequency range from 244 to 256 Mc.

The first frequency tripler converts the 244 to 256 Mc signal to a 732 to 768 Mc signal. Circuit simplicity indicated in the diagram above helps keep spurious oscillations to a minimum.

A shunt varactor arrangement is used where the varactor diode is a common element in each of three series-resonant circuits. The input circuit, resonant to the 244 to 256 Mc input signal, comprises  $C_1$ ,  $C_2$ ,  $C_3$ ,  $L_1$  and  $CR_1$ . The output circuit, resonant to the 732 to 768 Mc output signal, consists of  $CR_1$ ,  $C_5$ ,  $L_5$ ,  $C_6$ ,  $L_4$  and  $C_7$ . The third resonant circuit, consisting of  $CR_1$ ,  $L_2$  and  $C_4$ , is tuned to the second harmonic of the input signal frequency. This idler circuit improves the over-all conversion efficiency and reduces direct coupling between the input and output tuned circuits.

To assure that the varactor diode operates over the most nonlinear portion of its characteristic, self-biasing action is established by rectification in the varactor itself. Resistor  $R_1$  stabilizes the varactor bias voltage.

The over-all physical and electrical construction emphasizes high Q, minimum losses and minimum generation of spurious frequencies. Total power output to a 50-ohm coaxial cable is 7.5 watts in the frequency range from 732 to 768 Mc.

The second frequency tripler is a multiple-section resonant coaxial cavity. A varactor diode has the nonlinear reactance characteristic necessary for harmonic generation.

The input cavity represents a quarter-wave ( $\lambda/4$ ) at the fundamental input frequency (732 to 768 Mc) and  $3\lambda/4$  at three times that frequency.

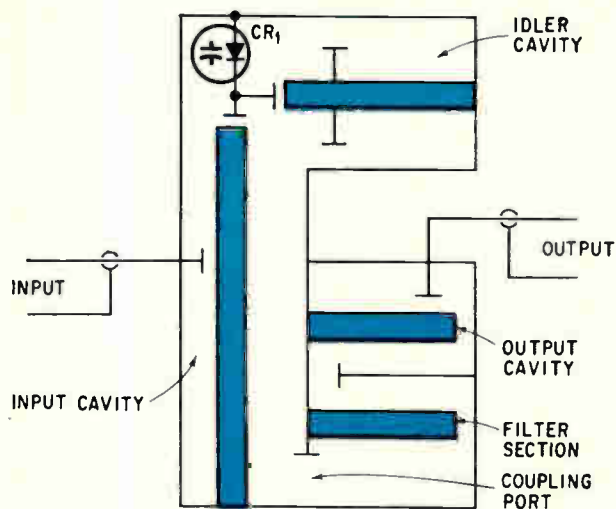

Second tripler uses cavity techniques to provide third-harmonic output with minimum of spurious frequencies.

Fundamental frequency energy is coupled into the cavity at a point that prevents harmonic energy from coupling back to the input. The varactor diode is capacitively coupled to the open end of the cavity, where it is excited by the fundamental frequency energy to produce harmonics. The cavity at the end of the module represents  $\lambda/4$  at twice the fundamental frequency and provides a path for the second harmonic idler current, which is necessary to improve the efficiency of frequency conversion.

The coupling port at the bottom of the input cavity provides critical coupling to the  $\lambda/4$  filter section. Another port at the bottom of the filter section provides coupling to the second  $\lambda/4$  filter section that serves as the output cavity. Physical dimensions within the cavities are carefully controlled to prevent the generation of undesired harmonics.

The position of the output coupling probe is chosen to give the desired 50-ohm impedance and to provide the required 60-db harmonic rejection. In this module—to an even greater extent than in the other modules—particular care is exercised to control spurious responses.

### Power supply

The schematic of the d-c/d-c power supply for operating the modules of the telemetry transmitter shows provision for two output voltage levels, 25 volts d-c and 50 volts d-c.

Operation of the circuit is based on the concept of storing energy in the magnetic field of a coil during one half-cycle, and then transferring that energy—plus some additional from the primary power source—into a capacitor during the next half-cycle.

Transistors  $Q_1$  and  $Q_2$  are the basic switching elements employed to obtain pulses of current



A. King McCord,  
President, Westinghouse Air Brake Company, says,



**“We’ve introduced the world to WABCO with Industrial Advertising.”**

“We gave *seven* individual companies a single corporate identity—virtually overnight. We let customers in thirty major markets know that Westinghouse Air Brake now ranks among the world’s most skilled and diversified suppliers—of earthmovers, drilling equipment, compressors,

automatic signal and control systems, electronic guidance detection and communications equipment, control valves, hydraulic and pneumatic cylinders, and—that’s right—air brakes. We told the story fast and inexpensively to hundreds of thousands of purchasing influences, with Industrial Advertising.”

***Advertising cuts the cost of selling . . .***

**ASSOCIATION OF INDUSTRIAL ADVERTISERS**



271 Madison Ave., New York, N. Y. 10016

## Hughes New Hi-Speed X-Y Plotting Instruments . . . plot alpha- numerics, graphics or halftone images with unequaled speed, brilliance and clarity — at big savings in systems integration costs.



**MODEL 401 SLOW SCAN TV MONITOR** Another first by Hughes, this unit utilizes a 5-inch storage tube and was designed for use with slow scan television systems. It provides both adjustable scan time and lines per frame. Resolves 600 black and white TV lines per useful tube diameter. Displays up to 6 grey scales. Offers four display modes and a complete complement of controls and input, output connectors. Compatible and easily integrated with most slow scan systems.



### Store transients with your standard oscilloscope

**HUGHES MEMO-CORDER® STORAGE INSTRUMENT** Most oscilloscope users find applications where the ability to store traces of non-recurring transients would save time, effort and expense. The economical solution is the Hughes MEMO-CORDER storage instrument. It is readily connected and adaptable to most conventional oscilloscopes. Compact and portable, it gives you oscillographic storage when and where you want it—at a moderate investment.

Matched amplifiers make the Hughes MEMO-CORDER indicator an ideal instrument for X-Y plotting.

For full information on the above instruments, write, wire, or call HUGHES INSTRUMENTS, 2020 Oceanside Boulevard, Oceanside, California. For export information write Hughes International, Culver City, California.

**HUGHES**

HUGHES AIRCRAFT COMPANY  
HUGHES INSTRUMENTS  
OCEANSIDE, CALIF.

## NEW POWER DIODE 2000 VOLTS—2 AMPS CONTROLLED AVALANCHE SINGLE CHIP

A new controlled avalanche diode with single chip and very low nanoamp reverse current in voltages of 50-2000 volts is now available. On special selection these diodes are available in 2200 volts. (These are conservative figures with approximately 20% safety factor.) All diodes have a 2 ampere rating without heat sinks and a forward voltage drop of approximately .90 volts, making them unusually desirable in high voltage power supplies. The now famous SLATER VACUPRESS process (Patent No. 2,710,713) produces diodes of ultra-high reliability. All gases and contaminants are removed from the interior by high vacuum pumping. The final package sealing contains six atmospheres pressure of a special gas. All packages are the same, measuring .225 x .250 with axial leads and metal to glass hermetic seal. This allows standardization of mounting diodes with different ratings. Very many different sizes and ratings of diodes can be eliminated and only one Slater diode is necessary. Call or write for further information. Desirable territories available for representation. Slater Electric Inc., Semiconductor, Glen Cove, N. Y.



Actual Size

Circle 201 on reader service card

# NEW

Packed with more important data than ever before... the 1964-65 issue of **Electronics Buyers' Guide**. Four great major sections: Product Listings; Index of Electronics Manufacturers; Government, Other Agencies and Technical Services.

# USED

Week in, week out, EBG is the industry's standard catalog-directory... a necessary working tool for the men who buy and the men who sell components, equipment, systems, materials and services.

### Electronics Buyers' Guide

A McGraw-Hill Publication  
330 West 42nd Street,  
New York, N.Y. 10036

# Probing the News

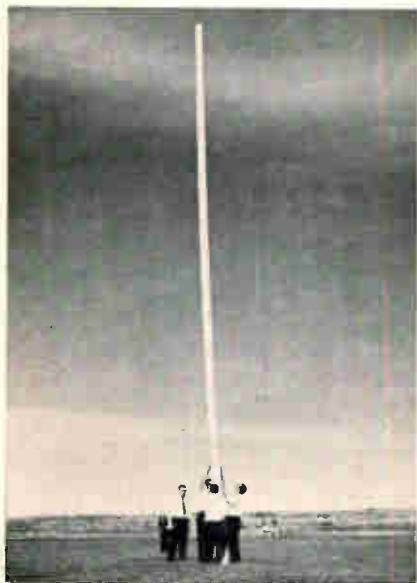

Inflatable antenna rises 50 feet above at field near Rome Air Development Center. Such antennas, tall but light and portable, are one way of overcoming the severe attenuation of radio signals by jungle foliage.



Airborne relay pod (foreground), hung on the wing of an Air Commando aircraft, extends the range of a 10-watt ground station up to 180 miles. Built by the Radio Corp. of America, the uhf pod is one way to beat the problems of line of sight and of radio signal attenuation in the jungle.



Combat transceiver is being developed by Rome Air Development Center for combat teams and air commandos. It weighs five pounds and is usable up to 25 miles line of sight. ▶

## Military electronics

# Anti-guerrilla gear

For trouble spots like South Vietnam it must be simple, light, rugged and cheap

By John F. Mason

Senior Associate Editor

**Counterinsurgency**, or guerrilla warfare, is a new kind of war for Americans and it demands a new kind of equipment. The nature of this new gear is difficult for Americans to comprehend, since it seems to go against all reason.

"To help us, the electronics industry must turn back the state of the art 30 years," says Col. Harry C. Aderholt, the new commander of the Special Air Warfare Center's First Air Commando Wing, in his headquarters at Hurlburt Field, Fla., one of the remote areas of the

sprawling Eglin Air Force Base complex.

The tough, 44-year-old veteran of the war in Southeast Asia explains his unorthodox observation: "Equipment has to be really basic. And rugged. Not only is a lot of it thrown out of aircraft and used under the worst conditions, but it must be operated by native troops who usually have no technical training whatsoever.

"Another requirement is to build low-cost equipment," he continues. "An electronics firm might develop

fancy, expensive gear for the Special Air Warfare Center but we would never buy it in quantity. We give away most of our equipment to native troops and we can't afford \$10,000 handouts. Units must be low-cost."

### Four urgent needs

The colonel describes four kinds of equipment his men need:

- **Homing beacon.** A good radio homing beacon is badly needed to guide planes carrying airborne troops or equipment to a drop zone. "The old World War II Rebecca-Eureka beacon is still probably the best one we've got," Col. Aderholt says. This 200-megacycle beacon system uses lobe-switched antennas to determine azimuth.

"Motorola, Inc., did develop the AN/HRT-2 beacon, but it costs \$1,200. We need thousands of cheap homing beacons that a man can jump with. They should have a range of at least 10 miles—preferably 20—for a plane flying at 500



Forward air control radio pack, manufactured by Sylvania Electronic Systems combines four transceivers and is light-weight, but has at least one drawback—it's expensive

feet. We don't care if it's vhf. If or uhf, so long as it can be integrated into the present aircraft system. We don't want a \$10 beacon that requires \$50,000 worth of new airborne gear."

- **Air strike control.** A good, cheap air-ground communications set is needed for controlling air strike operations. The AN/URC-4 emergency radio worked well, but it was expensive and unreliable from a maintenance point of view. It should be redesigned for mass production, transistorized and it should be cheap. The present set is of World War II vintage.

- **Survival beacon.** Downed pilots need a hand-held beacon with a three-to five-mile range to tell rescue pilots where to look. Such a beacon might be combined with the forward air controller's air-ground equipment.

- **Aircraft communications.** A very inexpensive, reliable, high-frequency system is needed for planes to communicate with each other and with ground stations. The range should be 1,000 miles.

### 1. Supply line

The commandos' needs are dealt with on three levels:

Off-the-shelf gear that can be modified and delivered within 120 days is tested at Eglin by the First Combat Applications Group.

Research and development equipment is built by, or for, the Air Force System Command's Rome Air Development Center at Griffiss Air Force Base, N. Y.

Long-range research for new ap-

proaches to guerrilla warfare are handled by the Defense Department's Advanced Research Projects Agency in Washington. The effort is called Project Agile.

**Off-the-shelf.** Finding equipment that can be modified quickly often poses a problem for the First Combat Application Group, the organization responsible for "developing, testing, and evaluating tactics, techniques and hardware to assure optimum effectiveness of airpower in a counterinsurgency role." Commercial products usually don't meet military specifications. Tubes might be second rate; the case may not be waterproof or it may not withstand G factors when dropped by parachute.

**Four-transceiver pack.** The Applications Group has tested two devices. One, tried out in Thailand and South Vietnam, was the Forward Air Control Pack, the TR 500A, produced by Sylvania Electric Products, Inc. The set consists of four transceivers: vhf/f-m, vhf/a-m, h-f/ssb and uhf/a-m. It is compact and versatile, but expensive. If the air staff accepts it, military specifications will be drawn up and industry will be invited to bid on production contracts.

The second device is one attempt to solve the problem of radio signal attenuation in heavy foliage and to extend the range between ground-based transmitters and receivers. In South Vietnam, attenuation is so bad that five miles is often considered a good range between two manpack radios. Sometimes it is far less. An Air Commando major

recalls a time when two South Vietnamese, equipped with walkie-talkies, got within 200 yards of each other before they were able to establish radio contact. Each had been following the other's approach by the movement of tall swampweed. If the radios hadn't worked when they did, the soldiers might have shot at each other.

The Applications Group is testing a uhf relay pod that can be attached to the wing of an Air Commando aircraft. At 5,000 feet, the pod extends the range of the two ground stations by many miles. A 10-watt transmitter, for example, reaches receivers 180 miles away. The pod, designated AN/RRQ-5, was developed by the Radio Corp. of America.

Another approach to beating the foliage problem is a 50-foot-high tactical antenna [photo].

**Research and development.** To attain the simplicity Col. Aderholt wants, the state of the art does have to be turned back in one sense, but it must also go forward. The complexity and versatility often associated with progress must be abandoned. Rome is doing this, while at the same time, it strives to shrink weight and volume, increase reliability and prepare equipment to operate in any environment. Whenever possible, designers are using microminiaturization, such as integrated circuits, deposited thin films and welded modules.

Rome got the assignment for work on six projects for air commando equipment in late 1960. The Center discovered that two of the projects were already active Army programs: a high-frequency single-sideband transceiver in the 2- to 30-megacycle band, and a vhf/f-m transceiver in the 30- to 76-megacycle band. Rome began monitoring their development with an eye to using the finished products.

Two radio sets called for were not being worked on by other services. They were a vhf/a-m set in the 100- to 156-megacycle band and a uhf/a-m set in the 225- to 400-megacycle band.

**On maneuvers.** Before specifying details of equipment performance, electronics engineers at Rome wanted to see what particular

problems the air commandos had. To do this, they went down to a Strike Command joint forces exercise in the Carolinas.

The engineers worked with combat control teams and air commandos, carrying the same equipment and doing everything the air commandos did—within certain limits. Many engineers, for example saw no reason to leave an airplane before it landed, or to wade through murky creeks when there was a perfectly good bridge nearby.

## II. Progress report

The engineers did learn a lot, however. For one thing, they came to appreciate the need for the 10-pound limit on communications gear allowed each man. Ten pounds doesn't seem like much until the 70-pounds of other equipment each man carries is taken into consideration, plus the fact that he must jump with all of it.

They also recognized the need for advanced power sources such as thermionic and thermoelectric converters and fuel cells. Air commando communications gear had to be free from limitations imposed by batteries.

Work on the two radio projects has started. For the vhf/a-m set, Rome is negotiating a contract for a two-year development effort. For the uhf/a-m set, Rome recently awarded a three-year contract to the Collins Radio Co. of Canada, Ltd., a subsidiary of Collins Radio Co. The Marine Corps is also interested in this equipment and is sharing the contract cost and providing engineering support.

The remaining projects both answered Col. Aderholt's requests. One was a low-frequency homing beacon, the other an X-band radar beacon. The I-f device was being developed by the Marine Corps, but no one was working on an X-band beacon. Rome therefore contributed funds and engineering assistance to the I-f device and contracted the Wilcox Electric Co. to develop the X-band beacon. Both, now finished, are being tested by the Tactical Air Command at Eglin.

**Project Agile.** Looking even further into the future than Rome does is the Advanced Research Projects Agency, which has been



Homing beacon HRT-2, used to mark drop- or landing-zones, is portable and operates at low frequencies. The Special Air Warfare Center would like something cheaper.

investigating various aspects of counterinsurgency requirements for the last several years. Project Agile, as it is called, has been made highly classified by the State Department in an effort to play down publicity on projects that take American military expeditions outside the United States.

Before the hush, however, it was openly discussed that Project Agile was concerned with improvement of mobility, communications, command and control of small forces in remote areas, detection of enemy troops and other targets, navigation for remote areas, and area fire weapons.

**Some surprises.** Engineers working on Agile were surprised to discover that, despite the great progress made in communications, almost nothing had been done to improve radio propagation in tropical environments. The agency initiated a research program in Thailand in 1962, which has grown bigger each year.

Another surprise came in the Indochinese Peninsula. Due to thunderstorms, the radio noise level at medium and high frequencies is higher than anywhere else in the world except the Congo Basin in Africa and the Amazon Basin in South America. It's 100 times greater than in the Panama Canal Zone.

This fact, plus the lack of radio frequency control, resulted in a program to improve the design of high-frequency communications equipment. New gear operating at 2 to 30 megacycles uses almost

vertical reflection from the ionosphere's D-layer for point-to-point transmission over distances of 5 to 500 kilometers. This led to basic and applied research in antenna design and improved power sources. Present high-frequency devices use unacceptable long antennas and bulky power supplies. For 1965, approximately 20% of the Agile budget is for communications research.

Surveillance studies include devices using much of the spectrum: acoustic, infrared, optical, photographic and radar. One example is development of a laser-illuminated system for night photography. About 25% of the Agile budget next year will go for surveillance.

**Budget climbs.** In fiscal 1963, Agile's appropriation rose to \$19 million from \$11 million in 1962. This year it's \$24 million, and \$30 million has been requested for 1965.

The agency is going to universities and corporations to seek solutions.

The search for expertise in producing this kind of equipment is not a short-range project. Col. Aderholt said: "If the Communists stick to their work, Vietnam will not be the last local war. 'Wars of liberation' are to be expected for a long time. We will probably be passing out electronic gear in Asia, Africa and in Latin America. And since we can't afford to keep spending what we're spending in Vietnam now, we'd better come up with something better that costs less."

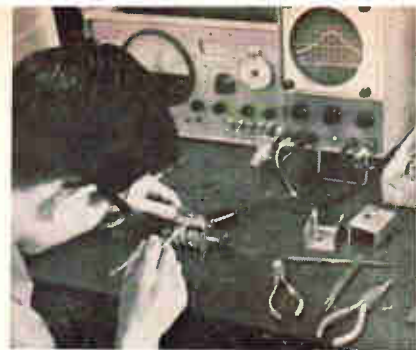

Vhf tuner for Yaou color set is aligned. Response curve is seen on scope.

Yaou color set is tested in lab. Scope shows signal applied to color-switching grid of the picture tube.

Consumer electronics

## Japan aims one-gun tube at U.S. color tv market

First transistorized color receiver for the consumer market uses an improved version of the Lawrence tube

By Charles Cohen

McGraw-Hill World News, Tokyo

**With an eye** on the American market, the Yaou Electric Co. of Japan has introduced a transistor-operated color television set with an eight-inch picture, a one-gun picture tube and no convergence circuits.

Yaou has applied for patents in the United States and five other foreign countries. It has also built into its set two features necessary for sales here: space for a uhf as well as a vhf tuner, and compliance with U. S. regulations on spurious radiation.

The company says that the receiver's picture is brighter than that of standard American makes, and that the set is almost as simple to service as black-and-white sets.

The receiver will sell next fall for \$375. Quantity sales in the U. S. could allow reductions to about \$275, the company says.

**Why now?** Several factors caused Yaou to introduce the set now. A picture tube and circuits suitable for a portable set were developed and transistors cheap enough and stable enough had become available.

Yaou uses a tube said to be an improvement of the Lawrence tube [p. 89]. Another Japanese manufacturer, the Sony Corp., has let it be known that it will begin production in three months of a Chromatron-type color tube, another one-gun device based on the Lawrence tube. Sony has not indicated whether it will make small tubes for transistorized sets or large ones for 17-inch pictures.

At present, most of Japan's color tv sets and all of the standard 16-inch color tubes are produced by two companies, the Tokyo Shibaura Electric Co. (Toshiba) and

the Matsushita Electric Industrial Co.

Toshiba, like Sony, has been working on a small Chromatron-type tube, but has disclosed no details. Meanwhile it produces about 1,000 sets a month, using a 70° deflection, shadow-mask tube.

Matsushita makes about 500 color sets monthly with a 90° tube and plans to expand its output this month.

**A new challenger.** Mitsubishi Shojo Kaisha, Ltd., has begun selling a six-inch, three-picture-tube set. It is making 1,000 of these sets a month, but expects sales to taper off when conventional sets are in greater supply. The three different-colored pictures are combined optically, and the viewer has the impression of peering into a knothole.

Among other manufacturers, Hitachi, Ltd., is developing a 16-inch, 90° shadow-mask tube and set, and Nippon Columbia has a new 11-inch shadow-mask picture tube with a 70° deflection angle.

Anticipating increased sales of color tv as a result of the Olympic Games in Tokyo this fall, Japan has boosted monthly production from about 500 in January to 1,266 in March and is aiming at a 5,000-a-month rate by 1965. Color picture tubes are still in short supply.

### How colornet works

Yaou's "colornet" system of reception uses a line-sequential presentation instead of the dot-sequential system used in the U. S. The



Japanese system switches color after each horizontal line. Yaou says this presentation requires 10 fewer transistors than a conventional circuit. There are 47 transistors in the Yaou set.

The color-switching signal is one-third of the horizontal scan frequency (5,250 cps). It is a three-level, step-type signal that goes to lowest level after highest level to give a continuous-color-sequence picture. Because of the low frequency, very little switching power is required, and radiation and other problems associated with switching at 3.58 megacycles are eliminated.

The picture-tube screen is composed of vertical color strips [see p. 89]. Since three lines are required for one color cycle, the picture is somewhat coarser than when using the shadow-mask tube. The use of lines limits the size of the set to about 12 inches. The company believes that for a larger set, the conventional three-gun, dot-sequential tube is more satisfactory.

**A color for each line**

In the Yaou set, each horizontal line activates one of the three primary phosphor colors. The color difference signal applied to the first grid of the picture tube must be changed for each line. To obtain the required signal, an offset sub-carrier demodulator is used.

The frequency of the crystal oscillator in the receiver is offset from the subcarrier frequency by one-third of the horizontal scanning frequency, the crystal oscillator frequency being below that of the carrier.

The crystal oscillator is synchronized with the color-synchronizing signal in the received signal. When synchronized, the phase of the crystal oscillator will coincide with that of the synchronizing signal once every three lines. The crystal oscillator phase will then advance or lag the color sync signal by 120° for each succeeding line, so that at the end of three lines the lag will reach 360° and the two signals are again in phase.

**Advancing phase.** To understand the color detector, assume that the phase of the crystal oscillator advances with respect to the sub-

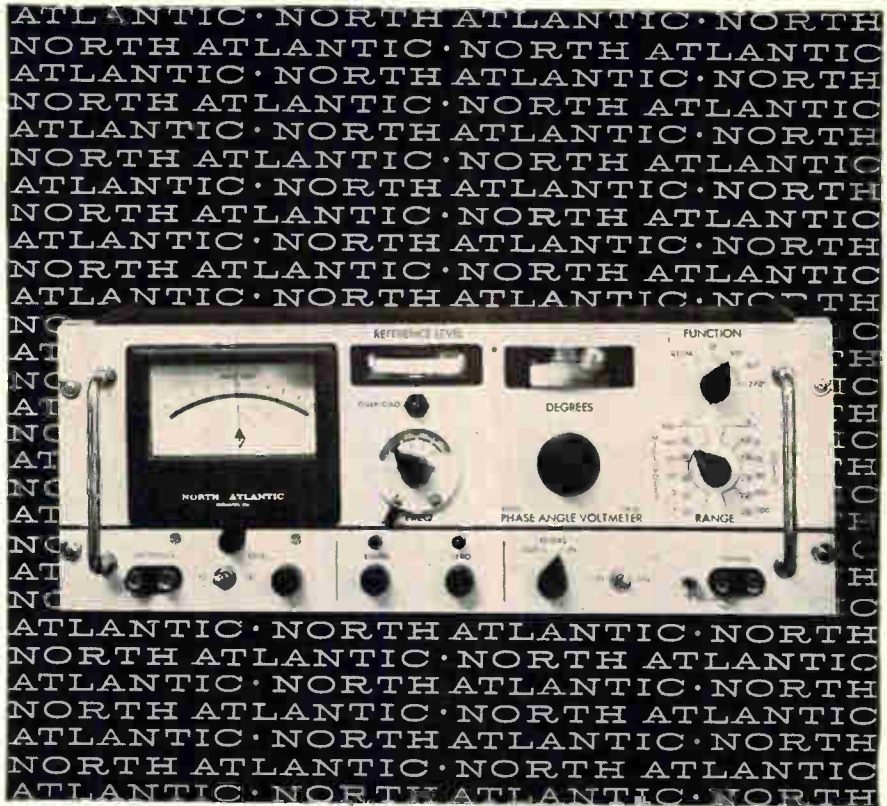

**how to measure in-phase, quadrature and angle while sweeping frequency to 100 kc**

North Atlantic's latest addition to the PAV line of Phase Angle Voltmeters\* enables you to make measurements while frequency is varying over half-decades without recalibration. The VM-301 Broadband Phase Angle Voltmeter\* provides complete coverage from 10 cps to 100 kc, and incorporates plug-in filters to reduce the effects of harmonics in the range of 50 cps to 10 kc with only 16 sets of filters. Vibration analysis and servo analysis are only two of the many applications for this unit. Abridged specifications are listed below:

Voltage Range.....	1 mv to 300 volts full scale
Voltage Accuracy.....	2% full scale
Phase Dial Range.....	0° to 90° with 0.1° resolution (plus 4 quadrants)
Phase Accuracy.....	0.25°
Input Impedance.....	10 megohms, 30µf for all ranges (signal and reference inputs)
Reference Level Range.....	0.15 to 130 volts
Harmonic Rejection.....	50 db
Nulling Sensitivity.....	less than 2 microvolts
Size.....	19" x 7" x 10" deep
Price.....	\$1990.00 plus \$160.00 per set of filters

North Atlantic's sales representative in your area can tell you all about this unit as well as other Phase Angle Voltmeters\* for both production test and ground support applications. Send for our data sheet today.



*\*Trademark*  
**NORTH ATLANTIC industries, inc.**  
TERMINAL DRIVE, PLAINVIEW, L. I., NEW YORK • OVERbrook 1-8600

carrier. Then the phase of the color synchronization signal and that of the crystal oscillator will coincide at the start of the first horizontal line. At the second line, the crystal oscillator phase will lead that of the synchronization signal by  $120^\circ$ .

At the start of the third line, the phase difference will be  $240^\circ$ . At the start of the fourth line, they will again coincide.

The same phase relationship occurs when the crystal oscillator output is phase-modulated with a

suitable sawtooth wave whose repetition frequencies obtain a signal whose phase varies in steps. Output phase advances  $120^\circ$  during the interval between horizontal lines. These axes are normally used for color signal demodulation for one-gun picture tubes. In this line-sequential receiver, it is thus possible to switch primary colors at the end of each horizontal line.

Because the crystal oscillator is highly stable, it is not feasible to phase-modulate it. Phase modulation is done in a buffer amplifier stage by varying the capacitance of a varactor diode.

This type of receiver cannot use a conventional automatic phase control circuit, to control the phase of the offset subcarrier oscillator. A three-interval control circuit was developed to synchronize the oscillator at every third line. To obtain the three-level step signal for the color-switching grids, a simple storage counter circuit is used, driven by the horizontal return pulse.

**Magnetics minimized.** The use of vertical color strips in the picture tube minimizes the defocusing

### Meanwhile, in the U.S. . . .

Portable, transistorized black-and-white tv sets are now being made in the U.S. On May 25 the General Electric Co. introduced a nine-inch set costing \$159.95. But transistor color tv appears to be several years off.

The reason for the delay is not technical; it is economic. Americans overwhelmingly favor large-screen sets. Eleven-inch black-and-white American portables, for example, are far more popular than the five-inch transistor sets Japan has been exporting. Japanese "tinyvision" tv is considered a novelty here.

Vacuum-tube sets are also less expensive. Some black-and-white sets can be bought for under \$100, while large-screen color tv is list-priced at under \$400 by the Admiral Corp. and Radio Corp. of America.

American manufacturers are selling color tv sets at the rate of one million a year, and are not anxious to change a winning formula.

Transistor manufacturers cannot match vacuum-tube prices yet. Texas Instruments Incorporated, for example, is trying to sell transistor kits to makers of black-and-white receivers. But a typical kit—containing 22 silicon and germanium transistors, 14 diodes and rectifiers, and a gate-control switch—costs \$16. That's 20% to 30% more than a comparable set of vacuum tubes.

However, the company sees two sales incentives. Makers of solid-state sets can offer five-year warranties to customers. And the gate-control switches to regulate picture-tube power are easier to design into small-screen sets.

When manufacturers come up with transistor devices competitive in cost with vacuum tubes for tv sets, the swing to solid-state tv will really begin. Texas Instruments believes tv transistor costs will be down to the vacuum-tube level in two years. In 1966, the company predicts, 300 million transistors will be sold throughout the world for tv sets.

---

only **4** basic materials... **1**...mylar\*.

...a new capacitor construction concept to give high performance and low cost. Filmatic® by Paktron

## Purer and Cheaper

Like the Chromatron, the color tv tube made by the Kobe Kogyo Corp. is based on the Lawrence one-gun system. But Kobe has introduced some refinements to increase color purity and reduce production costs.

Both tubes use a single electron beam to activate, in sequence, strips of different-colored phosphors on a color screen. But the Chromatron depends on a color-switching grid to focus the beam onto a particular color strip. The grid, whose potential is lower than the phosphor screen, acts as a convergent lens. Since the crossover point is between the grid and the screen, some of the beam's electrons may strike adjacent color strips, degrading color purity.

Kobe uses an adjustable focusing grid of vertical wires directly behind a vertical-wire color-switching grid. The focusing grid acts as a divergent lens; in combination with the color-switching grid, it necks down the beam to land precisely on one color strip. The color strips are also vertical.

The Chromatron also is expensive to produce because light shining through a uniformly spaced optical mask cannot be used to bake the phosphors on the screen. To insure that the beam's landing positions and the screen-line positions coincide, the Chromatron's beam itself must be used in fabrication. This requires evacuation of the tube each time one of the three colors is deposited. Excess phosphor must be washed off after each baking operation.

In the Kobe tube, however, the focusing grid prevents the electron beam from hitting more than one color phosphor. It also guides the beam to the right phosphors at the edges of the screen, where the beam bends.

Therefore, light can be used for baking the phosphors. Kobe makes the screen on an auxiliary glass plate, using masked light. Since the entire screen is produced outside the tube, manufacturing costs are sharply reduced. The screen, 7½ inches across, is installed in a 9-inch bulb.

But Kobe holds out little hope for making large-screen color tubes with its new process. It notes that large color-switching grids tend to be microphonic and produce interference, and that the picture becomes coarser as size increases.

effect of variations in the earth's magnetic field, Kobe Kogyo says. This helps make the set portable, since it need not be readjusted when it is moved. The earth's field

tends to expand the vertical cross-section of the electron beam. An expanded beam can be tolerated by vertical strips, but might overlap horizontal color strips.

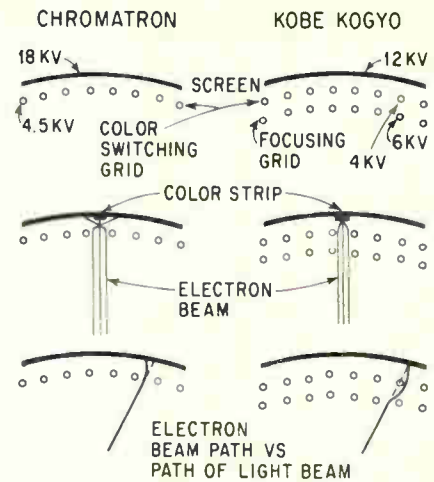

By adding the focusing grid (top), Kobe Kogyo says it avoids two problems of the Lawrence tube: beam fringing and deflection away from color strips.

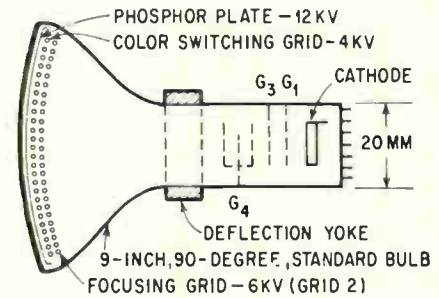

Locations of grids in tube



This unique combination provides a rugged self-case, high lead strength, excellent moisture resistance, improved life, high volumetric efficiency . . . all at a considerable savings in cost.

Available in three case sizes.

Range:	.001 mfd. through .5 mfd.
Voltage:	50-100-200-400-600 WVDC
Tolerance:	± 10% & ± 20%

\*DuPont



ACTUAL SIZE

**Filmatic®**  
Capacitors  
with  
RIPPLEWELD™



**PAKTRON**

DIVISION ILLINOIS TOOL WORKS INC.  
1321 LESLIE AVENUE • ALEXANDRIA, VIRGINIA

# Southern comfort

Top priority for the big satellite-tracker at Eglin Air Force Base in Florida is to watch for enemy missiles

By Thomas Maguire

Regional Editor

**Missile detection** and tracking has A-1 priority in the \$30-million phased array radar being completed at Eglin Air Force Base, Fla. Designated the AN/FPS-85, the giant sensor faces south, and is in effect a southern ballistic missile early warning system (BMEWS). It is automatically geared to lock on to any missile-like object crossing the equator and heading for the United States. Any object the radar picks up will be automatically compared with the signatures of those in its memory. If a missile is picked up, the computer will calculate its trajectory and point of impact.

Second priority assigned to the automatic uhf system is the mission the North American Air Defense Command originally said the

radar was being built to handle—to detect, track, and catalog unknown satellites. Third priority is to monitor known satellites on which additional orbit information has been requested by the defense command. Fourth is for keeping tabs on known satellites for which no new information is needed.

**Watches the equator.** The computer-directed system is able to do all this because of its search-while-track capability. It can sweep the equatorial sky continuously, functioning as a detector and tracker at the same time. All information is forwarded to the space detection and tracking system (Spadats) in Colorado Springs. At Spadats, an up-to-the-minute display is kept of everything moving around in space.

Men putting a protective coating over the radar receiver are dwarfed by its huge size. Thousands of pear-shaped dipole antennas are embedded in the plastic foam below the receiver surface. Each receiver element requires a crossed set of dipoles, each transmitter element a single pair.



Although described by the Air Force as a research and development instrument, the FPS-85 will nevertheless be an operational warning device for missiles launched at the United States from submarines in southern waters, from land bases to the south, or from the Soviet Union, launched the long way around.

**Startup this summer.** Power turn-on at the giant experimental space track sensor [Electronics, Feb. 14, 1964, p. 24] is scheduled for July 1. It is expected that tests will be completed and the system will reach full operation by the beginning of 1965.

For another year after that, the system will remain under jurisdiction of the Air Force electronic systems division, while being evaluated for acceptance by the Air Defense Command as a sensor for Spadats.

The experimental aspect of the radar will aid in pointing the way to even more advanced surveillance techniques, according to George H. Harlan, project engineer of the Rome Air Development Center. He describes it as "an experimental system, but designed for easy transition into operational status."

**Biggest radar.** The FPS-85 can reach out several thousand miles—the exact range is classified. Undisclosed also is the number of transceivers in the gigantic array which requires a structure 13 stories high and more than a city block long. The Air Force says only that the number of elements switched electronically to form and steer the radar beam is in the thousands.

**Digital conversation.** Designed to operate in a completely automatic mode, the radar will be directed by remote control from Spadats, about 1,000 miles away. The interface is provided by two computers talking to each other in digital language over high-quality phone lines (see diagram).

At Spadats, a Philco 2000 will forward instructions from the Air Defense Command, and these instructions will be received by an IBM 7044 at the radar site. The computer in turn will feed into the radar programer, a special-purpose computer designed by the Bendix Corp. The Bendix Radio Systems

division, Towson, Md., is prime contractor for the FPS-85. Its engineers designed the most critical feature of the array radar, the beam-steering technique.

**Method.** To form a pencil beam, the antenna array must radiate a planar phase front. The beam is then normal to the phase front. The beam is steered by inserting the proper phase increment between antennas so that the phase front is tilted in the desired direction. As shown, two tapped delay lines, each tap corresponding to a new row or column of the array, are employed. One delay line is used to steer in the  $\alpha$  direction; another to steer in the  $\beta$  direction.

To steer to a given direction, the radar programmer selects the proper frequency from the frequency generator by means of the digital frequency selector. This is then mixed with a fixed frequency, and fed into the tapped delay line. The phase increment between taps is a function of the frequency selected. The output at each tap is then mixed back with the selected frequency to yield the original  $f_0$  or  $f'_0$  at a phase angle depending on the

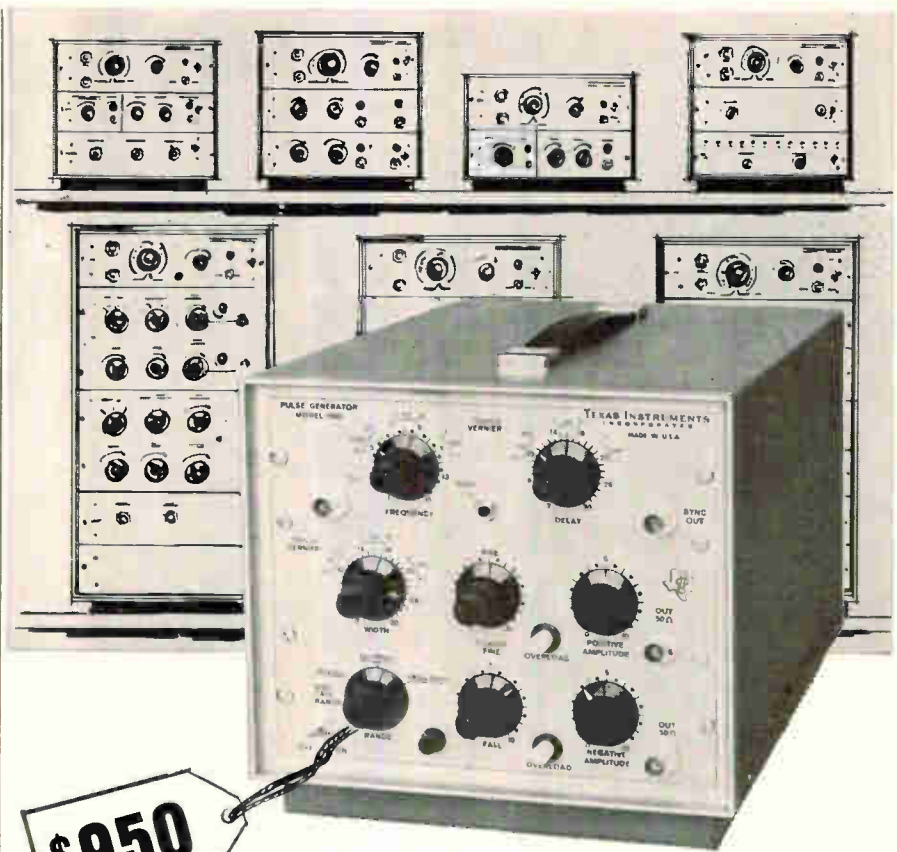

**\$950**

**a new one off the shelf...  
quality, high-spec pulse generator  
featuring variable rise and fall**

The Model 6613 General Purpose Pulse Generator fills the need for a low-cost, high-quality test instrument with exceptional performance specifications. It is a general purpose instrument ideal for most pulse applications such as testing integrated circuits, digital circuit design, system design and checkout, testing of diodes and transistors.

The 6613 provides coincident positive and negative pulses determined by an internal clock generator or external source, with rep rate variable in 6 steps. Pulse width and delay are also variable in 6 steps. Amplitude is variable from near zero to 10 volts, with overload protection provided. Solid-state circuitry is utilized throughout. The compact unit measures 8½ in. high, 8½ in. wide, 12 in. deep and weighs only 10 lb.

**SPECIFICATIONS**

**Clock Pulse Repetition Frequency**

15 cps to 150 cps	15 to 150 kc
150 to 1500 cps	150 kc to 1.5 mc
1500 cps to 15 kc	1.5 mc to 15 mc

**Delay**

30 to 300 nano-sec	30 to 300 microsecs
300 nanosecs to 3 microsecs	300 microsecs to 3 millisecs
3 to 30 microsecs	3 to 30 millisecs

**Width**

30 to 300 nano-sec	30 to 300 micro-sec
300 nanosecs to 3 microsecs	300 microsecs to 3 millisecs
3 to 30 microsecs	3 to 30 millisecs

**Pulse Amplitude**—10 v into 50 ohms

**Rise and Fall Times**—variable: less than 10 nanosecs to 1 microsec, 1 microsec to 100 microsecs, 100 microsecs to 10 millisecs, minimum rise time typically 8 nanosecs

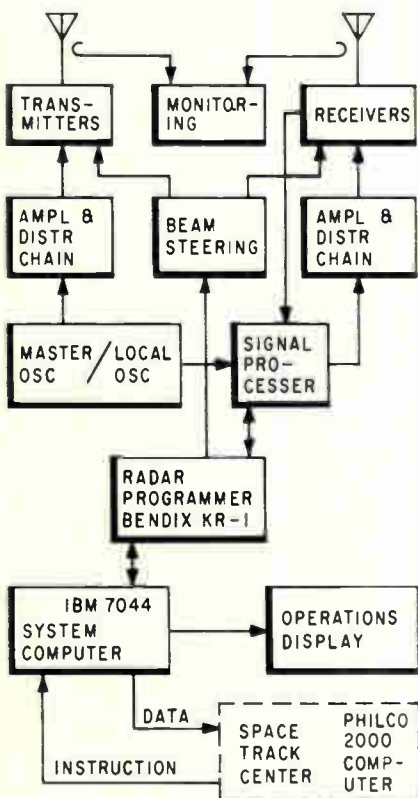

Highly automated, the FPS-85 radar system is designed to operate on instructions received from a computer 1,000 miles away.

INDUSTRIAL PRODUCTS GROUP



**TEXAS INSTRUMENTS  
INCORPORATED**  
P. O. BOX 66027 HOUSTON, TEXAS 77006

663

# DURANT

**ELECTRIC COUNTERS**  
provide accurate, high speed  
**COUNTING by**  
REMOTE CONTROL

• **RECTIFIER**  
• **(and coils)**  
• **COMPLETELY**  
• **ENCLOSED**

The internal rectifier in the Durant "Y" Series results in much longer life, quieter operation, and more accurate counts . . . by providing uniform DC operation from erratic AC pulses. This space-saving feature, combined with the coils and working mechanism also completely enclosed within the compact case, makes Durant Electric's outstanding counters suitable for every Machinery, Equipment, Instrumentation or Systems application. Popular standard models are UL and CSA approved.



"Y" Electric Series  
(Model 6 Y-1-RMF)  
1000 CPM



"CS" Electric Series  
(larger size —  
larger figures)

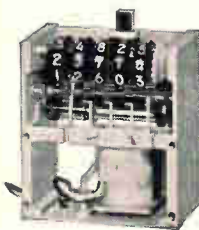

"YE" Electric Series  
Push Button Reset  
(Model 5-YE-8947-Q)  
1500 CPM

"Y" Electric Series  
Push Button Reset  
(Model 5-Y-11479)  
No external case

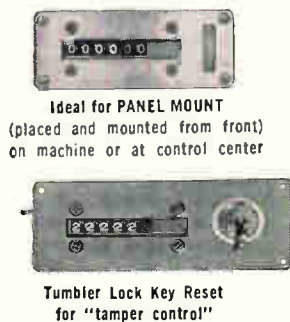

Ideal for PANEL MOUNT  
(placed and mounted from front)  
on machine or at control center

Tumbler Lock Key Reset  
for "tamper control"

### STANDARD MODELS FOR YOUR OEM, MACHINE, INSTRUMENT or SYSTEM

"Y" Electric — Small, compact, AC counters with integral rectifier for high speed and long life. Four, six or seven figures.

"CS" Electric — Larger case size and figures for rugged, heavy-duty applications.

"YE" Electric — Electric or finger-flick instant reset. Hermetically sealed model available.

"Y" Special Electric — Extremely compact for built-in applications — no external case.

Send for Electric Counter Catalog  
**DURANT MANUFACTURING CO.**  
612 N. Cass Street, Milwaukee, Wis. 53201

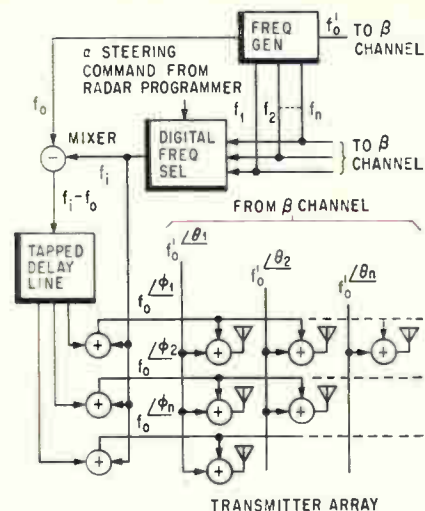

**Beam-steering method.** Mixers only are shown; however, each mixer feeds a final r-f amplifier which in turn feeds an antenna at the radiated frequency  $f_0$  plus  $f'$ . Beta channel is similar to the alpha channel shown.

frequency selected by the digital frequency selector.

A similar process is performed for each steering coordinate, and the phase shifted signals are mixed at the transmitters. Each transmitter drive signal has a composite phase angle composed of the phase angle due to the  $\beta$  phase shifter, and the phase angle due to the  $\alpha$  phase shifter.

**Changeable.** On command from Spadats, the radar can change its search fence pattern from one which is optimal for missiles to one optimal for satellites; it can change its search mode, equalize power loads for searching and tracking jobs, and determine tracking traffic load needs.

No human intervention will be required at Eglin to operate the radar, although personnel will be on duty to monitor performance and for maintenance. System operation will be monitored automatically: the phase and amplitude of the thousands of transmitters, the noise temperature and phase of the receivers.

Besides furnishing the 7044, the International Business Machines Corp. is doing the system programming; Airborne Instruments Laboratories, signal processing of receiver inputs; and Sanders Associates, Inc., the beam-forming networks. Rome Air Development Center is technical and contractual manager.

# DURANT®

**COUNTING INSTRUMENTS**

Accurately Count Everything . . . EVERYWHERE



"YE" SERIES  
HERMETICALLY  
SEALED FOR  
MILITARY



MODEL 3-3-5-Y  
ELECTRIC  
COUNTERS  
ONE FRAME



MODEL 6-Y  
ELECTRIC  
PREDETERMINING  
COUNTER



PUSH BUTTON  
RESET ELECTRIC  
FOR MILITARY  
APPLICATION

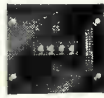

4 FIGURE  
"Y" ELECTRIC  
PANEL  
MOUNT



"SP-MF"  
ELECTRIC  
PREDETERMINED  
COUNTER

**REPRESENTATIVES IN ALL PRINCIPAL CITIES**

# Log voltmeter-converter accurate to 0.2 db

It has a precisely divided logarithmic scale, movable linear decibel scale and range of over one decade

**Previous techniques** for log conversion, using diodes or nonlinear potentiometers, have been limited in range, accuracy, stability or frequency response. Hence a design effort has been directed toward developing a logarithmic conversion unit that would be relatively simple to maintain and have an accuracy unaffected by time or wide variations in ambient conditions. The results are incorporated in the HLVC-150 log voltmeter-converter.

This instrument permits continuous measurement accurate to 0.2 db, or 2% of measured level, of a-c or d-c voltages over a 70-db range. A 3,160-to-1 ratio of maximum to minimum voltage is indicated on one scale. Equal accuracy of measured level and equal readability over the extended range are advantages of the logarithmically divided scale.

The HLVC-150 is said to be the first voltmeter ever offered with a precisely divided logarithmic scale, with a movable linear decibel scale, and with a range of over one decade. The wide continuous range eliminates frequent switching of scales with the resulting switching transients and loss of time. A manually movable db scale covering a range of  $\pm 75$  db permits readings in decibels using any selected zero db reference to eliminate subsequent addition or subtraction for reference correction.

**How it works.** Log conversion is accomplished by a tapped linear potentiometer, a tapped toroidal transformer, a resistive divider network and a selected load resistor.

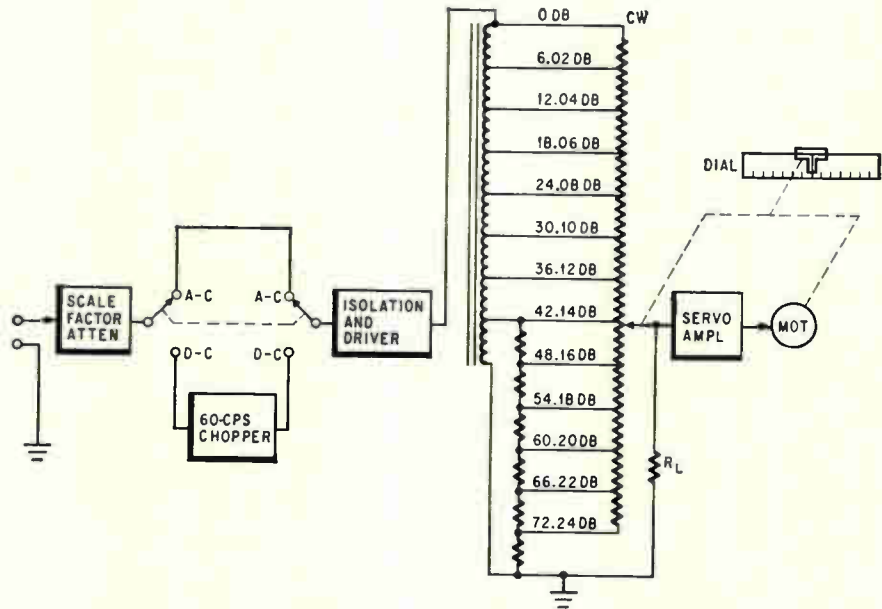

All of these elements are stable with time and ambient conditions.

As shown in the block diagram, a-c signals either pass through the scale factor attenuator directly or are attenuated 40 db, after which they pass through a cathode follower and a driver amplifier. The latter provides a voltage proportional to the input voltage across the toroidal autotransformer of the log conversion unit. D-c signals are chopped at 60 cps prior to being amplified. To accommodate the differences in the average value of the square waves and sinusoidal waveforms, the over-all gain of the preamplifier is changed when the attenuator switch is rotated to the a-c position.

The toroidal tapped autotransformer provides clamping voltages with 6.02-db separation to the top seven equally divided sections of a three-turn tapped potentiometer. It also provides a low driving impedance for a resistive dividing network providing clamping voltages for the remainder of the potentiometer taps. The potentiometer is divided into a total of 12

equally spaced sections with a 6.02-db voltage ratio between adjacent taps.

The copper mandrel of the log conversion potentiometer is grounded to minimize capacity coupling effects between the wiper and the mandrel. Capacitance coupling between high level potentiometer taps and wiper, significant at high frequencies, is neutralized by connecting the wiper to a small trimmer capacitor which is connected to a voltage source proportional to and  $180^\circ$  out of phase with the voltage across the toroid. A load resistor  $R_L$  provides a loading function between the taps which approximates the true log function with a maximum error of 0.5% throughout the range.

D-c output voltages of 1 mv/db or 0.1 mv/db are provided for logarithmic recording. Input voltages can be d-c or a-c from 10 cps to 50 kc. Input impedance is 11.1 megohms shunted by 50 pf. Price is \$1,450.

Houston Instrument Corp., 4950 Terminal Ave., Bellaire 101, Tex.

Circle 301 reader service card



**Judge us  
by the  
Companies  
We  
Serve**

## HOWCOR LAMINATIONS Are Standard Components of many of the World's Best Known Products

In the products of internationally famed manufacturers every component must contribute to product performance.

The number of world-known manufacturers who use HOWCOR Laminations (partial list on request) is your best reason for getting the latest facts on HOWCOR facilities, standards, engineering services and prices.

Write for Bulletin 100 and catalogs on HOWCOR Motor Laminations . . . Nickel Alloy Transformer Laminations . . . Silicon Steel Transformer Laminations.

**HOWCOR**  
**LAMINATIONS**  
A Division of Howard Industries, Inc.  
3912 McLean Ave., Chicago, Illinois 60647

## New Components and Hardware

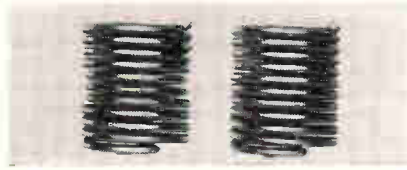

### Coiled wire inserts replace worn threads

Two helically coiled wire inserts have been developed for a constant prevailing torque value over an unlimited number of assemblies and reassemblies of threaded fastener systems. Pitch-Lok and Perma-Thread inserts are used wherever a screw thread might fail because of impact, vibration, strain or stress, especially in light or soft materials such as aluminum, magnesium and other non-ferrous materials, plastics and laminates. The inserts are made of 18-8 cold drawn stainless steel wire, with a minimum tensile strength of 200,000 psi, rolled to Government Specifications AMS-7245C as a continuous one-piece thread form. Sizes available are: 4-40, 6-32, 8-32, 10-24, ¼-20, ⅝-18, ¾-16, and 10-32, ¼-28, ⅝-24, ¾-24. Insert lengths available are: 1, 1½, 2, 2½ and 3 times the nominal diameter of the screw.

Republic Industrial Corp., 633 Third Ave., New York 17. [311]

### Staked rotary switches result in savings

Substantial savings can be attained with new staked rotary switches. The multisection, 1½-in.-diameter switches feature quality comparable to screw-assembled equivalents and are designed for use in a

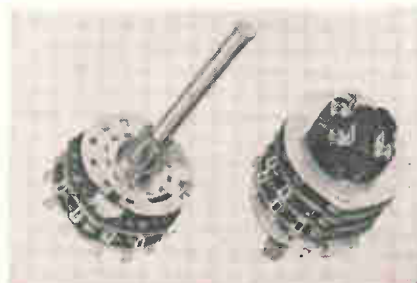

wide range of applications. Savings are achieved by eliminating strut screws, lockwashers, nuts and complicated hand assembly. Three models are currently in the line—types J, K and N. Type J is available in up to four sections, with each section ranging from 6 poles, 2 positions, to single poles, 11 positions; type K, in up to three sections, each having switching capabilities identical to type J sections; and type N, with up to four sections, each ranging from 4 poles, 2 positions, to single pole, 11 positions. Temperature range for all types is -25° to 85°C. Contacts are double-wiping and self-cleaning. They can be supplied in densely-silver-plated spring brass or silver alloy. The former will break currents on resistive loads up to 1 amp, 28 v d-c. or ½ amp 110 v a-c. Amperage ratings are doubled with silver alloy. All contacts will carry (not make or break) 5 amps.

Oak Mfg. Co., Switch Products Division, Crystal Lake, Ill. 60014. [312]



### Variable inductor changes with current

An electrically variable inductor, Varitor type 3D-VI-20, exhibits changes in inductance proportional to a change in applied current, completely eliminating all mechanical adjustments. Inductance range is 85 μh to 1,800 μh, with a tracking accuracy of ±3%. Q is greater than 100 at 2 Mc. Temperature coefficient is 0.1% from 0 to 150°C. Cur-



rent range is 0 to 150 ma. Size is 0.6 cu in. The inductor is completely potted, and is designed for printed-circuit applications in oscillator, inductance compensation, and automatic-frequency shift circuits. Price is \$18.50.

Data Delay Devices, Highway 10, Dover, N.J. 07801. [313]

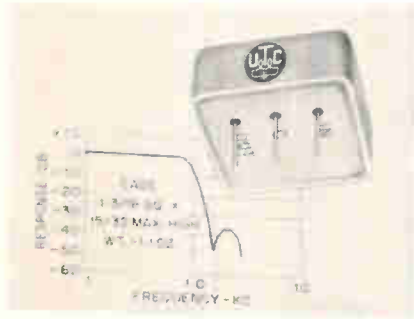

## Low-pass filter for printed circuits

A hermetically sealed ultraminiature low-pass filter is guaranteed to MIL-F-18327B, MIL type FR4RX-11YY. From d-c to 800 cps response is flat within  $\pm 0.3$  db. Attenuation at 940 cps is less than 3 db, and at 1 kc it is less than 6 db. At 1,450 cps and above, attenuation is more than 35 db. Source and load are 47,000 ohms. Straight pin terminals and flat construction suit the unit for printed-circuit applications.

United Transformer Corp., 150 Varick St., New York 13. [314]



## New delay line requires little space

A new development in delay-line manufacturing, the Nanaline-C, is capable of replacing bulky coaxial cable in many applications. Designed for high-frequency operation, these units can be provided in delays of from 5 to 300 nano-

## Low Cost / High Quality Ratio



Model TR040M

## New ERA highly regulated DC power source provides continuously variable output, 0-40 VDC @ 0-500 ma for only **\$99**

Compare the *price* of the new ERA all-solid state Model TR040 with other make power supplies providing the *features* and *specs* shown below. You'll agree that here is a truly unique power supply whose cost/quality ratio makes it ideal for the broadest possible range of applications, from laboratory to equipment-component use.

### FEATURES

- Compact, Lightweight
- Highly Stable
- Tight Regulation
- Low Ripple Content
- Constant Current Operation
- Short Circuit Proof—Automatic Recovery
- Automatic Current Limiting
- Vernier Control for Fine Adjustment
- Remote Programming Provision
- Remote Sensing Provision
- Isolated Outputs
- Front Panel Metering (Optional)
- Fully Repairable
- Relay Rack or Bench Mounting
- For Laboratory or System Use

### SPECIFICATIONS

Input: 105-125 VAC, 50-1000 cps  
 Output: 0-40 VDC at 0-500 ma  
 Line Regulation: Within  $\pm 0.015\%$  or 5 mv, whichever is greater  
 Load Regulation: Within 0.03% or 5 mv, whichever is greater for 0-100% load change  
 Ripple: Less than 800  $\mu$ v RMS  
 Operating Temp. Range:  $-20^{\circ}\text{C}$  to  $+55^{\circ}\text{C}$  free air, full rating  
 Constant Current Operation: 0-500 ma  
 Remote Programming Constant: 500 ohms per volt  
 Remote Sensing: Connections provided  
 Short Circuit Protection: Automatic current limiting  
 Thermal Protection: Automatic thermostat operation  
 Series or Parallel Operation: Connections provided  
 Output Terminals: Ungrounded, either positive or negative terminals may be grounded  
 Cooling: Internal convection-cooled  
 Panel Size:  $3\frac{1}{2}'' \times 7\frac{1}{2}''$  (designed for bench or half relay rack mounting. Two units may be mounted side-by-side in a 19" standard rack dimension for dual outputs.)  
 Price: \$99.00 (for current/voltage metering, add \$15.00 and suffix M. Relay Rack Mounting Kit—single or dual mounting, add \$5.00.)

Write for ERA's new complete catalog #131 today!



**ELECTRONIC RESEARCH ASSOCIATES, INC.**

Dept. E-6, 67 Factory Place • Cedar Grove, N. J. 07009 • (201) CEnter 9-3000

SUBSIDIARIES: ERA Electric Co. • Advanced Acoustics Co. • ERA Dynamics Corp. • ERA Pacific, Inc.

the new standard  
in ultra portability...

## PEMCO 110 general purpose data recorder



**17 lbs-35 watts-dc to 100 kc  
fm and direct-ac or dc power**

The Pemco Model 110 general purpose data recorder sets a new standard in ultra-portability for high-performance instrumentation recorders. Less than 1/5 the size, weight and power consumption of most conventional portable recorders, the Model 110 boasts a signal to noise ratio of 40 db FM and 35 db Direct, long term speed stability of better than  $\pm 0.5\%$  from a 22-34 VDC input, and FM center carrier drift of only 0.1% over a full reel of tape.

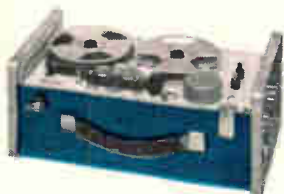

Shown above with the Model 14 rechargeable Power Pack, the Model 110 offers standard 2-speed drive over a range of  $1\frac{1}{8}$  to 30 ips, with 3-speed ac and 4-speed dc available. With optional converter, the model 110 easily operates from 12v dc, in addition to the standard 28v dc or 117v ac.  $\frac{1}{4}$ ",  $\frac{1}{2}$ " or 1" tape widths accommodate 2, 7 or 14 standard IRIG channels respectively. Inter-

changeable plug-in FM and direct record/reproduce electronics.

Entirely compatible with double bandwidth and IRIG standards, the PEMCO Model 110 offers lab precision for extreme and remote environments. Ask your PEMCO representative or write us direct. We'll be pleased to send complete technical and operating data.



**PACIFIC  
ELECTRO  
MAGNETICS**

942 Commercial Street  
Palo Alto, California • (415) 321-1177

## New Components

seconds at a range of low impedance levels. The company says rise time ratios up to 40-to-1 are available with considerable savings in both space and cost.

Bel Fuse Inc., 198 Van Vorst St., Jersey City 2, N.J. 07302. [315]

## Low-noise chopper has d-c to 5-kc drive

A transistor chopper, type 7030, may be driven over a direct current to 5-kc range from a 5.7- to 14-v rms, sine or square wave source. Chopper noise will not exceed  $35 \mu\text{v}$  rms, and d-c signal levels of  $\pm 15$  v or peak at 1 ma may be modulated. Operating temperature range is  $-30^\circ$  to  $+100^\circ$  C. Price is less than \$45 in quantity.

Airpax Electronics, Inc., Cambridge, Md. [316]

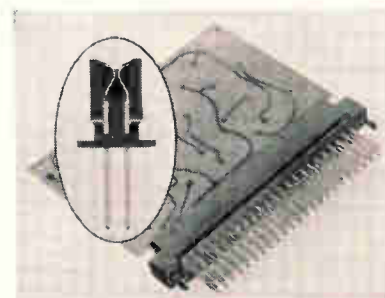

## P-c receptacles with spring contacts

One-piece taper leaf spring contact with 0.045-in. square wire-wrap terminal is available in a new series of edge-type printed-circuit receptacles. The contact and terminal are forged in one piece from 0.045-in. square phosphor bronze, to eliminate welded joints. The spring tempered phosphor bronze has maximum retention characteristics and provides consistent performance under severe operating conditions. The square terminal post provides the optimum configuration for highly reliable electrical connections in high speed, wire-wrap production operations. Precision Connectors Division, Electronic Fittings Corp., 29 Sugar Hollow Road, Danbury, Conn. [317]

## New Instruments

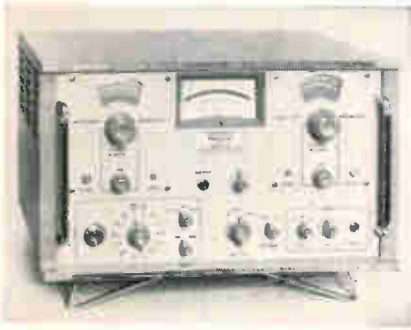

### Wave analyzer uses solid-state circuitry

This extended-range, frequency-selective voltmeter is said to be the first 10 kc to 15-Mc wave analyzer to employ all solid-state circuitry. Model 128A measures signals from 30  $\mu$ v to 30 v (-90 to +32 dbm) across its entire frequency range, referred to 600-, 135- or 75-ohm balanced or unbalanced systems. Oscillators locked to crystal reference frequencies assure frequency accuracy on an order of 20 cpm. Two crystal filters provide dual bandwidth selectivity at 250 and 2,500 cps. Output of the 2,500-cycle crystal filter can be monitored audibly through either an a-m or an ssb detector.

Sierra Electronic division of Philco Corp., 3885 Bohannon Drive, Menlo Park, Calif. [351]

### Compact and rugged edgewise meter

An edgewise electrical indicating meter measures 1 by 2 in., is hermetically sealed and offers both vertical and horizontal mounting. The case is made of steel which allows mounting in magnetic or non-magnetic panels as well as stacking without recalibration or interaction. A wide selection of



ranges is available. Special features include an anti-parallax scale which allows readings to be made from wide angles without parallax error. Dual-magnetic movement allows high sensitivities with low power requirements while still using the proven, pivot and jewel type suspension.

WacLine Meters Division, WacLine, Inc., 35 South St. Clair St., Dayton, Ohio 45402. [352]



### Polar recorder plots automatically

A new polar-coordinate pattern recorder, series 1530, automatically plots patterns of antennas, sound transducers and other receiving or radiating devices. Both the chart turntable and high-speed pen system are controlled by solid-state servo amplifiers. Vacuum paper hold-down; 50 inches-per-second writing speed; rack mounted, hide-away turntable; and precision plug-in, multifunction pen-system potentiometers are featured.

Scientific-Atlanta, Inc., P.O. Box 13654, Atlanta, Ga. 30324. [353]

### Pressure transducer covers low range

A low-range pressure transducer has been designed for applications where small size and light weight are a requirement. Type 4-353 is said to be the smallest unit on the market in its absolute pressure range of 0 to 1 lb per sq in. It weighs 7 oz and is 2½ in. long and 1½ in. in diameter. The transducer was designed for measurements of airborne high-altitude pressures,

**KAY**  
ELECTRIC COMPANY  
Maple Avenue, Pine Brook, Morris County, New Jersey

Frequency Range: dc to 1000 mc.  
Impedance: 50-70-90 ohms.  
Attenuation: 0-101 db in 1 db steps.  
Insertion Loss: 0.2 db at 500 mc  
Max. error: 0.9 db at 500 mc.  
VSWR: 1.2:1 to 250 mc, 1.5:1 to 1 kmc.  
Price: \$110, \$75 for 6 step.

**KAY**

Attenuator  
**438-A**

dc to 1000 mc Miniature Attenuator

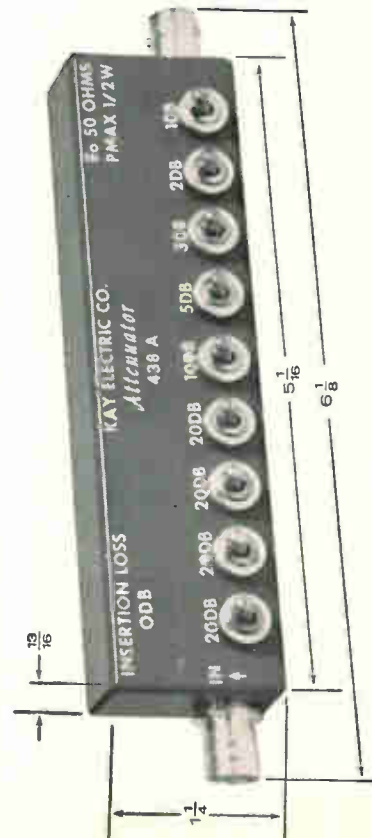

# FIRST

REALLY

# PORTABLE

## WIDEBAND RECORDER / REPRODUCERS

for field or airborne applications



P-4000

- **SMALLEST PORTABLE** — 1 cubic foot, utilizing 10 $\frac{1}{2}$ " NAB reels
- **LIGHTEST WEIGHT** — 45 pounds
- **LOWEST POWER** — 60 watts
- **WIDEST BANDWIDTH** — 1.2 megacycle at 120 ips
- **FIVE SPEEDS** — all automatically equalized



P-5000

- **CHOICE OF 3 BANDWIDTHS** — 1.2 mc, 1.5 mc, 2.0 mc at 120 ips
- **WEIGHT** — 85 pounds
- **SIZE** — 2 cubic feet
- **BI-DIRECTIONAL OPERATION**
- **FIVE SPEEDS** — all automatically equalized
- **10 $\frac{1}{2}$ " NAB REELS**
- Portable or 19" Rack Mount configuration
- Available with 200 kc FM record electronics

## FAIRCHILD

WINSTON RESEARCH  
CORPORATION  
A SUBSIDIARY OF FAIRCHILD CAMERA  
AND INSTRUMENT CORPORATION

6711 SO. SEPULVEDA BLVD., LOS ANGELES 45, CALIF. • ORCHARD 0-3305 • AREA CODE 213  
1625 "I" STREET, N.W., WASHINGTON 6, D.C. • NATIONAL 8-2588 • AREA CODE 202

## New Instruments



altitude-chamber pressures, and wind-tunnel pressures. Operable temperature range is  $-100^{\circ}$  F to  $+275^{\circ}$  F. Sensitivity is 20 mv. Thermal sensitivity shift is within  $\pm 0.005\%$  per deg F over the compensated temperature range, and combined linearity and hysteresis is  $\pm 0.5\%$  or better of full range output. Price is \$340.

Consolidated Electroynamics Corp., subsidiary of Bell & Howell Co., 360 Sierra Madre Villa, Pasadena, Calif. [354]



## Combination ratio set for calibration labs

Operational features of a universal ratio set and a direct-reading ratio set are combined in a new instrument. The device permits sharing of decade switch combinations. Model 1407 consists of a six-dial universal ratio set with additional circuit components to facilitate its use as a high performance direct-reading ratio set. The six dials permit one-part-per-million resolution for any ratio from 1 to 2,000,000 for calibrating devices such as potentiometers and off-value resistors. As a direct-reading ratio set, model 1407 can be used for comparison of resistors whose nominal values are the same. It also provides inter-comparison of resistors whose ratio is 5:1 or 10:1. Total nominal resistance of model 1407 is 2,111.110 ohms as a universal ratio set and

2,000 ohms as a direct-reading ratio set. Limit of error as a universal ratio set at 25° C, without correction, is 0.002% or 0.002 ohm, whichever is greater. As a direct-reading ratio set, this limit is 4 parts per million; if unknown is within 0.1% of standard.

Honeywell, Denver Division, 4800 E. Dry Creek Road, Denver Colo. [355]

### Versatile counter of solid-state design

A 50-Mc fully solid-state counter, the model 40-91 has an 8-digit, in-line readout. It also has bed printer output, remote operation capabilities, nine standard output frequencies and eight scaling outputs. The input may be a-c or d-c coupled with trigger level control and decade attenuation. Input impedance is 1 megohm. In addition to frequency, the instrument measures time interval, period—single and multiple, ratio—single and multiple, and it counts and self-checks. The basic unit can be used for bench operation or it fits a 14-in. rack.

Northeastern Engineering, Inc., Manchester, N. H. [356]



### Pressure transducer needs no amplifier

A miniature type transducer, the LPT-10 is designed primarily for pressure measurement and control applications in industry and military ground and airborne systems. A precision wirewound potentiometer element provides excellent output characteristics without any need for electrical amplification. The instrument is designed for pressure ranges of 0-1 to 0-400 psi (absolute, gage or differential). Higher pressure ranges are available in other models.

Precision Sensors, Inc., 1133 Main St., Paterson, N.J. [357]

# FIRST 2 MEGACYCLE LABORATORY RECORDER / REPRODUCER

with new features for data collection and analysis

- **WIDEST BANDWIDTH** — 2.0 mc or 1.5 mc at 120 ips
- **LOWEST WOW AND FLUTTER** — 0.2% peak-to-peak from dc to 10 kc at 60 ips
- **LOW DISTORTION SIGNAL ELECTRONICS** — for RF or predetection recording
- **VARIABLE PHASE RESPONSE** — for signal analysis applications ( $\frac{f_c}{10} = \pm 80^\circ$ )
- **SEARCH AND SHUTTLE** — optional at 180 ips
- **FIVE SPEEDS** — 7½, 15, 30, 60 and 120 ips, all automatically equalized
- **Separate Switching** of any combination of filter and equalizer while operating at any tape speed, for improved S/N ratios for certain types of data.



L-6000

### SOLID STATE AUTOMATIC GAIN CONTROL AMPLIFIER

- **DYNAMIC RANGE COMPRESSION** — switch selectable, 40 db input to 7 db output or 27 db input to 2 db output
- **TWO SELECTABLE INPUT RANGES** — 0.01 to 1.0 volt rms or 0.10 to 10 volts rms for nominal 1 volt peak-to-peak output
- **BANDWIDTH** — 10 cps to 8 mc
- **ATTACK TIME** — 1 microsecond
- **DISTORTION** — 55 db, predominately second and third harmonic
- **SIZE** — seven AGC units mount in 5¼" vertical across standard 19" rack
- **NO ADJUSTMENTS**



## FAIRCHILD

WINSTON RESEARCH  
CORPORATION  
A SUBSIDIARY OF FAIRCHILD CAMERA  
AND INSTRUMENT CORPORATION

6711 SO. SEPULVEDA BLVD., LOS ANGELES 45, CALIF. • ORCHARD 0-3305 • AREA CODE 213  
1625 "J" STREET, N.W., WASHINGTON 6, D.C. • NATIONAL 8-2588 • AREA CODE 202

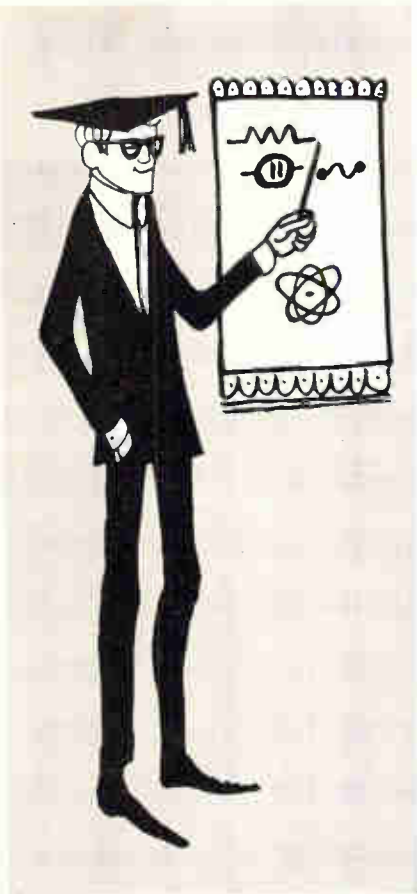

## workability

(pre-production training)

WESTern PENNSylvania has a time-tested and proved-in-use plan by which employees—adaptable, productive people with a variety of industrial aptitudes—will be trained in advance for whatever skills are needed for YOUR particular operation at no cost to you. For details on this ability . . . and for complete information on financing plans for plant, machinery and equipment, and working capital . . . and WESTern PENNSylvania's favorable tax climate, mail coupon, wire or call collect.

### WEST PENN POWER

an operating unit of ALLEGHENY POWER SYSTEM



INDUSTRIAL SHELL BUILDINGS available at \$2.95 to \$3.25 a sq. ft. completed to your specs in 60-90 days.

Area Development Department Phone: 412-TE 7-3000  
WEST PENN POWER  
Greensburg, Pa. 15602

Please send me information on:  Pre-production Training  
 Favorable Tax Climate  Financing Plans  Industrial Properties  
ADA4-8E

Name \_\_\_\_\_  
Title \_\_\_\_\_  
Company \_\_\_\_\_  
Address \_\_\_\_\_  
City \_\_\_\_\_ State \_\_\_\_\_  
Zip \_\_\_\_\_  
Code \_\_\_\_\_ Phone \_\_\_\_\_

## New Semiconductors

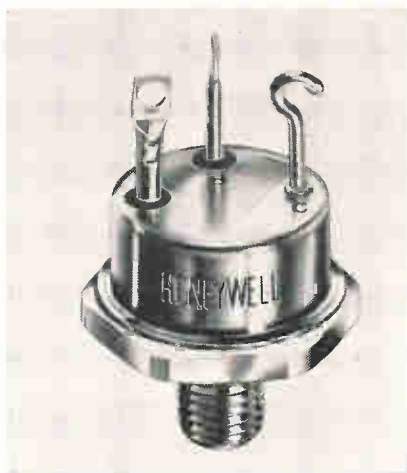

### Silicon transistors deliver 30 amperes

A series of 30-amp silicon planar transistors are designed for high-gain, high-frequency military applications. The triple-diffused power devices are rated to dissipate 100 w at 100°C case temperature. They are designated MHT 8301-8304 and are packaged in a 7/8-in. hex stud-mounted case. Design limits are:  $BV_{CEO} = 80/100$  v;  $BV_{CBO} = 60/80$  v;  $BV_{EBO} = 8$  v. Operating performance with collector current of 10 amp includes  $h_{FE} = 40-120$  and 100 minimum;  $V_{BE}(\text{sat}) = 1.5$  v and  $V_{CE}(\text{sat}) = 0.6$  v,  $I_{CBO} = 10 \mu\text{a}$  at  $V_{CB} = 60$  v;  $f_T = 25$  Mc. minimum. Units are priced in 100-quantity lots at \$73-\$100.

Honeywell, Semiconductor Products Div., 2755 4th Ave. S., Minneapolis 8, Minn. [331]

### Controlled rectifier with bulk avalanche

This controlled rectifier series is guaranteed to withstand a high critical rate-of-rise of forward voltage ( $dv/dt$ ) of 200 v per  $\mu\text{sec}$ . The new semiconductor is a high-voltage (up to 1,300 v prv) epitaxial, 70-amp (110 amp rms) unit exhibiting bulk avalanche characteristics. The series provides the design engineer with a device that will overcome problems arising from rapid increases of anode-to-cathode voltages. At the same time, the

bulky filtering circuits that were used in the past to protect the system from steeply rising voltages may be eliminated or at least reduced in size, complexity and cost. The new series consists of 24 devices designated 70,71, or 72REB60 through 130. The 70 types possess a single control lead; the 71's, a dual control lead; and 72, a flag terminal. Packaging conforms to JEDEC outline TO-49.

International Rectifier Corp., 233 Kansas St., El Segundo, Calif. [332]



### Photoconductive cells of cadmium selenide

Two vacuum-deposited cadmium selenide photoconductive cells have been announced. At one foot-candle, type NSL-364 has a 5,200-ohm resistance; type NSL-367 has a 100,000-ohm resistance. Both types exhibit high sensitivity with excellent speed of response characteristics. Enclosures are glass and metal measuring: 0.250-in. barrel diameter, 0.296-in. flange diameter, 0.185 in. high. Leads are 0.017 in. in diameter and 1.5 in. long.

National Semiconductors, Ltd., 230 Authier St., Montreal. [333]

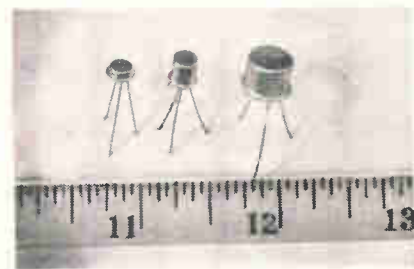

### Reference diodes made by planar process

A line of 6-v, planar, voltage reference diodes meet or exceed all MIL-S-19500 C requirements. They

feature temperature coefficients to 0.0002% per deg C, and temperature range from  $-55^{\circ}\text{C}$  to  $+100^{\circ}\text{C}$ . Reference voltage spread is available to  $\pm 1\%$  or better, with reference currents from 10 ma to 100  $\mu\text{a}$  and lower. Dynamic impedance is 10 ohms maximum at 10 ma. Rugged transistor header construction is offered with three package options, and stability is guaranteed.

Continental Device Corp., 12515 Chadron Ave., Hawthorne, Calif. [334]

## Integrated circuits etched in silicon

Newly developed integrated circuits contain the equivalent of 28 active components—six resistors and 22 transistors. Each of the circuits is etched in a silicon wafer approximately 0.050 in. square and 0.006 in. thick. Designed for use in computers, missile and aircraft guidance systems, they will switch in five billionths of a second.

Sylvania Electric Products Inc., 730 Third Ave., New York, N.Y. 10017. [335]



## Varactor diodes for high-voltage use

Epitaxial varactor diodes of gallium arsenide, models XA900 through 903 and XA905 through 908, have applications in harmonic generators, parametric amplifiers and microwave sweep circuits. They offer a minimum cutoff frequency up to 300 Gc. Minimum reverse breakdown voltage is as high as 50 v. Parameter uniformity between devices is said to minimize circuit design problems encountered with some other varactors.

Texas Instruments Inc., 13500 North Central Expressway, Dallas. [336]

# UNITRON INCORPORATED

## PRECISION 115V 400 CPS SINE WAVE FROM A 28V DC SOURCE

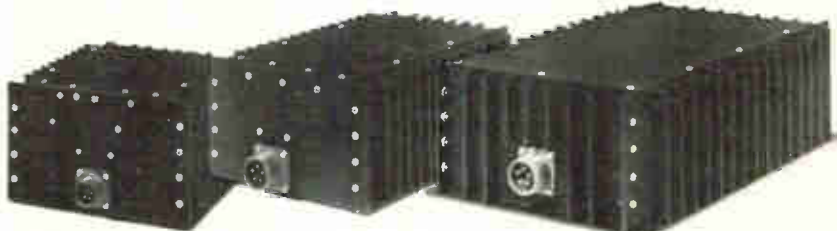

4S1125-1P  
125VA

4S1250-1P  
250VA

4S1500-1P  
500VA

These high performance static inverters surpass the extreme conditions of applicable military and FAA specifications for airborne equipment and are available at economical prices from stock. In addition they feature • guaranteed reliability • protection of output from no load to short circuit under any and all conditions • the input is protected against reverse polarity, high transients and high input voltage • low distortion • voltage regulated • high efficiency • stable frequency • light weight.

Write For Information On These And Other Static Inverters

1624 N. FIRST ST.  
BOX 1331

GARLAND, TEXAS  
AC 214 BR 6-8591

OTHER UNITRON PRODUCTS  
ON PAGES 103 & 105

Circle 202 on reader service card

## HAVE YOU CONSIDERED USING PHOTOCELLS?

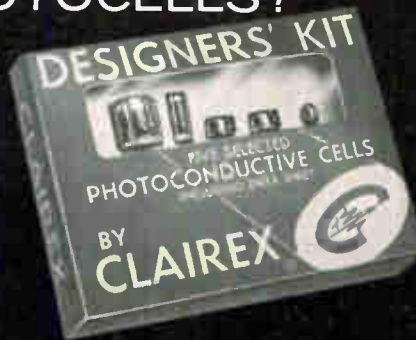

## WE'VE JUST MADE IT EASY FOR YOU ...

Free On Request —  
Designers' Kit Information  
plus New 1964 Edition  
16 page Designers' Manual

New! — from Clairex — a selection of photoconductive cells, varying in sensitivity, spectral response, speed and size to suit most applications, and including the CL505, CL603A, CL704L, CL707 and CL902 — in convenient kit form complete with technical data — only \$10.00.

# CLAIREX

"The LIGHT Touch in Automation and Control"

8 West 30 Street, New York, N. Y. 10001, 212 MU 4-0940

## NEW DI-ACRO 24-INCH BOX FINGER BRAKE

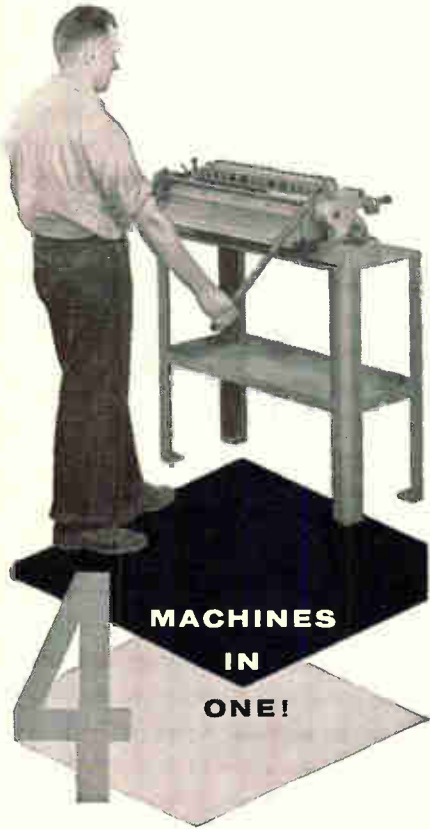

**UNDERCUT FINGERS** and one inch clearance permit forming chassis with up to 1/2-inch flange and clearing reverse bends from front of machine. Micrometer Gauge instantly positions material for forming to die accuracy in experimental labs, model shops, short-run production.

**A NEW 12-inch Brake** with 16 gauge steel capacity is available for forming smaller parts.

For free illustrated folder see your nearest Di-Acro distributor or write to us.



### DI-ACRO CORPORATION

436 Eighth Avenue Lake City, Minnesota

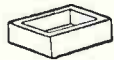

1. BOX AND CABINET FORMER... forms all widths from 3/4" to 24" by 1/4" steps.



2. BAR FOLDER... folds of hems up to 16 gauge mild sheet steel across full width.



3. RADIUS FORMER... forms radii by positioning forming edge or with special radius fingers.



4. OPEN END FORMER... forms open end shapes by replacing box fingers with open end finger.

## New Subassemblies and Systems



### Discriminator occupies small panel space

An f-m subcarrier discriminator, which fits in 15/16 by 3 1/2-inch panel space, permits 18 channels in one standard rack panel. Model FDS30 is complete, has its own power supply, input filter, output filter, deviation meter and output amplifier delivering  $\pm 2.5$  v to a 600-ohm load. All Inter-Range Instrumentation Group (IRIG) channels are available. Unit uses the Magmeter principle, a pulse averaging technique. Linearity is better than 0.2% of bandwidth.

Airpax Electronics Inc., Fort Lauderdale, Fla. [371]

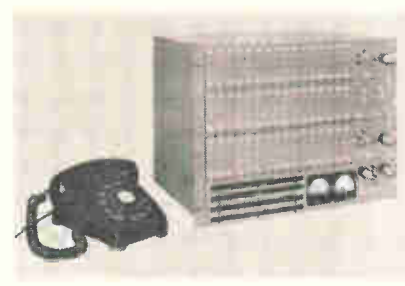

### Miniature terminal for data and telegraph

The Mi-Te-Mux (miniature terminal multiplexing) data and telegraph terminal consists of a unitized assembly, designed for

mounting in standard relay racks or cabinets. The equipment, measuring 2 cu. ft. and weighing less than 100 lb., is designed for 16-channel dual-diversity operation. It is complete with frequency-shift keyers, frequency shift converters, low-voltage power supplies for transistor-circuit operation, line battery power supplying d-c to receiving loops, as well as loop current regulators, jack field and test facilities. Individual channel keyers and converters are repairable plug-in modules, easily accessible from the front of the terminal. All active circuit elements and rectifiers are solid-state devices. Active circuit components are available for test and maintenance purpose by use of extender module or patch cable during operation.

Northern Radio Co. Inc., 143 W. 22nd St., New York 11. [372]

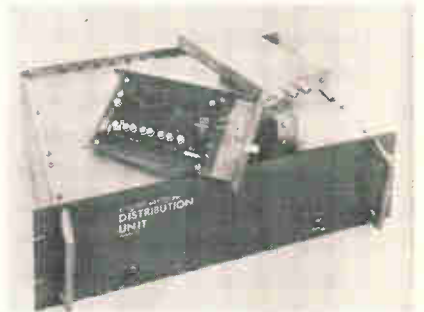

### Distribution unit in modular design

A new frequency distribution unit, model 50 series, is used for the derivation, shaping and transmission of standard precision frequencies. Each distribution unit installation is designed with standard off-the-shelf modules to provide a custom-engineered system meeting individual requirements. Standard modules consist of: decade divider/drivers; pulse drivers; sine-wave filters; line drivers; telephone line drivers; power supplies; special modules of custom design for special application. Frequencies from 1 pulse per sec to 1 Mc are available from standard units. All modules are contained within a standard chassis unit that measures 5 1/4



in. high, 19 in. wide and 13 in. deep. Typical cost of units is between \$900 and \$3,000 each (including oscillator).

Electro-Metrology, 2202 South Wright St., Santa Ana, Calif. [373]

## D-c power modules are scr pre-regulated

Compact d-c power modules are available with outputs of 4 to 30 v and 4 to 6.5 amp in both military and industrial configurations. While maintaining the low output impedance (0.001 to 0.2 max) and good transient response (50  $\mu$ sec) of transistor regulation, these modules also feature silicon-controlled-rectifier pre-regulation, resulting in a more efficient power control. The scr circuitry is well isolated so that the units meet rfi requirements. Regulation is 0.01%; ripple, 0.5 mv; and size, 4 by 6½ by 7 in. ACDC Electronics, Inc., 2979 N. Ontario St., Burbank, Calif. [374]

## Oscillator-preselector in 14 octave ranges

A new tunable oscillator-preselector is available in 14 octave ranges from 50 Mc to 750 Mc. The device combines a low-loss tunable band-



pass preselector in three sections, with a precision-tracked, solid-state local oscillator to provide a highly stable output of 10 mv minimum. Fourteen models are available, each covering one frequency octave with 100% overlap. Internal voltage regulation of the unit plus temperature compensation assures high stability in the oscillator. A tuned buffer amplifier also incorporated in the circuit prevents pulling and maintains the high oscillator output.

Telonic Engineering Co., 480 Mermaid St., Laguna Beach, Calif. [375]

# UNITRON INCORPORATED

**1000VA OF PRECISION 115V 400 CPS  
SINE WAVE FROM ANY 60 CPS OUTLET**

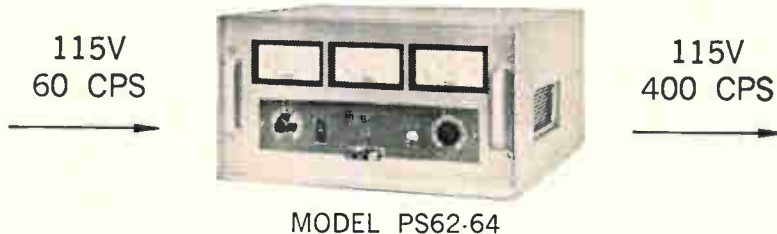

This unit offers freedom, versatility, and flexibility never before experienced in a 400 cycle power source. Rack mounted for powering complete ground systems or in the cabinet for laboratory, quality control, offsite presentations, and production. This unit features • precision and adjustable frequency • low distortion • voltage regulated • adjustable voltage • light weight for portability • complete metering • economically priced • overload and short circuit protected.

Write For Information On These And Other Frequency Converters

1624 N. FIRST ST.  
BOX 1331

GARLAND, TEXAS  
AC 214 BR 6-8591

OTHER UNITRON PRODUCTS  
ON PAGES 101 & 105

Circle 203 on reader service card

**INDICATOR LIGHTS** for your miniaturization program must be of high reliability. To assure this, we offer such vital features as: Watertight construction; resistance to vibration and corrosion; high-heat plastic, or glass, lenses; rugged brass terminals; anti-rotation (locked) construction; phenolic insulation of Mil. Spec. grade; 7 lens colors, etc.

## SUB-MINIATURES

by **DIALCO**

### For NEON or INCANDESCENT LAMPS



T-2

The T-2 Neon Lamp is available in two types: NE-2D (MS25252) for 105-125 V AC-DC; and the High Brightness type NE-2J (not MS) for 110-125 V AC only. In DIALCO units the current-limiting resistor is built-in (U.S. Pat. No. 2, 421,321).



T-1 3/4

Typical assemblies shown here: No. 137-8836-931 with built-in resistor (conforms to MS25237); No. 181-8836-931 (water-tight) with built-in resistor.

The T-1 3/4 Incandescent Lamps are available in voltages ranging from 1.3 to 28 V. Typical assemblies shown here: No. 162-8430-931 (conforms to MS25256) . . . No. 134-3830-375-9 (with rotatable readout lens); and No. 174-8430W-131 (water-tight, with dimmer cap).

Samples on Request—at Once—No Charge

For complete data, request Catalogs on Sub-Min. Indicator Lights

Foremost Manufacturer of Pilot Lights

**DIALIGHT** CORPORATION  
60 Stewart Ave., Brooklyn 37, N.Y. • (212) HYacinth 7-7600

Units Mount in 15 32" Clearance Hole



No. 137-8836-931



No. 162-8430-931



No. 181-8836-931



No. 134-3830-375-9



No. 174-8430W-131

(Units shown approx. actual size)

## New Microwave



### Cavity oscillator offers high stability

A miniature, solid-state, cavity oscillator features extremely high-frequency stability and low-voltage power requirement for vhf, uhf and microwave applications. Stable to 1 part in 100,000 per deg C over the range from  $-54^{\circ}\text{C}$  to  $+90^{\circ}\text{C}$ , the oscillators occupy less than 2.5 cu in. and require only 28 v d-c power input. They achieve very high performance by virtue of a solid-state circuit tuned by a miniature Invar cavity possessing rigid dimensional stability over the entire operating temperature range. Tuning over a 10% band is done by a mechanical set-screw adjustment. Optional varactor voltage tuning is available with a 50-Mc range resulting from a 60-v change in tuning input. Model DG504 operating at 1 Gc with 20 mw output power, is available. Price is \$750 each; less for quantity requirements.

Sanders Associates, Inc., Microwave Products Department, 95 Canal St., Nashua, N.H. [391]

### Frequency multiplier produces high power

A solid-state frequency multiplier that produces high power outputs at 500, 1,000 and 2,000 Mc, the



model 1000-1 consists of three independent varactor frequency doublers which may be connected in series or used individually. With an input of 250 Mc at 25-w nominal power, the new varactor multiplier provides output power in excess of 15 w at 500 Mc. At a frequency of 1,000 Mc, the output is 6 w, and at 2,000 Mc, more than 2-w output can be realized. At all operating frequencies, spurious frequency rejection is more than 50 db. Each doubler stage includes individual filtering and output ferrite circulator. This makes each stage completely independent and usable in itself or in combination with the other doubler stages.

LP Associates, 2255 Carmelina St., Los Angeles, Calif. [392]

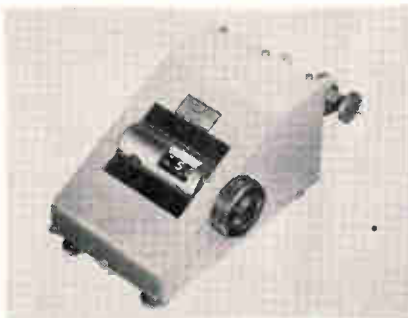

### Digital wavemeter eliminates charts

In production is a digital wavemeter used to set or determine the exact frequency of a microwave signal directly, without the use of charts. The unit employs a special mechanism (not a cam), which linearizes the travel allowing a 3-digit counter to be used in setting or determining frequency. Reading error, prevalent in drum-type dials, is eliminated completely. The wavemeter is a right circular cylinder cavity resonating in the  $\text{TE}_{011}$  mode. Spurious responses are suppressed by careful use of special absorbing material. Cavity is of invar construction for minimum expansion, with polished silver internal surfaces, and a ball-bearing drive mechanism for trouble-free performance. An absorption-type wavemeter, the instrument oper-

ates in the 60- to 90-Gc range. Counter resolution is 20 Mc. Absolute accuracy is 0.25% of reading; relative accuracy, 0.1% of reading. Loaded Q is 1,400 at mid-band. Dip at resonance is 1 db minimum. Price is \$1,600.

Microwave Components & Systems Corp., 1001 S. Mountain Ave., Monrovia, Calif. [393]



### Ssb generator delivers 5 milliwatts

A compact, single-sideband generator, model 90GS96-1, has a guaranteed output of 5 mw with 20-db suppression. The unit provides upper and lower sideband frequencies at separate outputs over the design band without adjustment. Outputs of 10 mw and more are also feasible. The model illustrated is provided with a 3-db hybrid that can be used to divide the power and provide the necessary  $90^{\circ}$  relationship for modulating the crystals. Other units are available with or without the i-f hybrid operating over the frequency ranges 8.5 to 9.6 and 9.5 to 10.6 Gc.

Microwave Development Laboratories, Inc., 87 Crescent Road, Needham Heights, Mass. [394]

### Klystron synchronizer tunes by single knob

Any klystron in the range from 1 Gc to 12.4 Gc can be phase-locked to the stability of a crystal reference with the model KS123 klystron synchronizer. The all-solid-state Lock Box features continuous tuning from 2 Gc to 12.4 Gc with a stability of 1 part in  $10^8$  per sec or 1 part in  $10^6$  per week at normal ambient temperature. With a crystal oven, stability can be improved to 1 part in  $10^7$  per week. The syn-



chronizer and associated klystron oscillator provide an extremely stable signal for such applications as microwave frequency standards, doppler systems, radio astronomy receivers and parametric amplifier pumps. Operation is simplified by single-knob tuning and a stable indicator lamp which is energized when the klystron is phase locked. The operator merely sets the klystron to the desired frequency and adjusts the synchronizer control until the indicator lights. The klystron will remain phase-locked at the set frequency with complete absence of drift and a minimum of incidental f-m. Klystron reflector voltages up to 5,000 v d-c are available to accommodate a variety of oscillator tubes. The synchronizer can also be used for frequency stability monitoring and f-m monitoring. Price is \$1,750.

Frequency Engineering Laboratories, Farmingdale, N.J. [395]

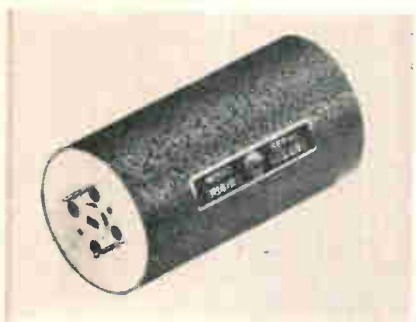

### Ferrite isolator uses RG-98/U waveguide

This broadband, millimeter-wave ferrite isolator, model M157A, offers a minimum isolation of 20 db with a maximum insertion loss of 1.5 db over the 50- to 65-Gc frequency range. Input vswr is 1.25 maximum; power is 100 mw maximum. The unit utilizes RG-98/U type waveguide and is fitted with UG-385/U flanges. Its insertion length is only 2¾ in. Unit price is \$895.

FXR, a division of Amphenol-Borg Electronics Corp., 33 E. Franklin St., Danbury, Conn. [396]

# UNITRON INCORPORATED

## 400 CPS 3 $\phi$ TO 60 CPS 1 $\phi$ AT 3 5KVA ALL SILICON SOLID STATE FREQUENCY CONVERTER



The Model PS-62-66 is an all silicon solid state frequency converter with proven performance in both airborne and air-transportable systems where precision 60 cycle is required from a 400 cycle source. This unit features

- proven reliability
- high performance
- high efficiency
- low distortion
- voltage regulated
- light weight
- 25,000 feet altitude
- MIL-I-26600
- excellent stability
- short circuit protection.

Write For Information On These And Other Frequency Converters

1624 N. FIRST ST.  
BOX 1331

GARLAND, TEXAS  
AC 214 BR 6-8591

OTHER UNITRON PRODUCTS  
ON PAGES 127 & 129

Circle 204 on reader service card

## TYPE 406 PULSE RECEIVER



\*  
SMALL  
SIZE  
\*  
High  
Performance  
\*

The CEI Type 406 Receiver is designed for wide band pulse reception using complete solid state circuitry. This permits small size, low heat dissipation, low power consumption, and high performance. Four, pre-tuned, crystal-controlled channels are switchable from the front panel. \*Discrete frequency bands are available between 60 mc and 155 mc. A panel mounting is available to accept up to three units in a standard 19" rack. The receiver can be used with any 21.4 mc center frequency signal monitor such as the CEI Type SM-9310A.

Frequency Range .....60-155 mc\*  
Type of Reception ..... Pulse  
Noise Figure ..... 6 db maximum  
IF Bandwidth ..... 2 mc  
Tangential Sensitivity...-95 dbm minimum  
Size ..... 5" H, 4.5" W, 14" L  
Power ..... 115v AC, approx. 10 watts

Communication Electronics Incorporated

4908 HAMPDEN LANE, BETHESDA 14, MARYLAND

## New Production Equipment



### Vibration test fixture gives added precision

A frequency-response test fixture is available that provides precise test data on rate gyros, integrating gyros, angular accelerometers and linear accelerometers. It works in conjunction with a rate table or centrifuge, and consists of a rotating table mounted on, and integral with, a precision right-angle mounting base and a remote speed-control unit. With the new device, the cross-talk inaccuracies of vibration testing methods have been greatly reduced.

Standard Precision, Inc., 4105 W. Pawnee, Wichita, Kan. 67201. [421]

### Numerical positioning control for tools

A new, solid-state electronic positioning control, the Centrepoint 200, is designed for machine-tool or production-tool control. For machine-tool applications, it is adaptable to either straight-line milling or point-to-point positioning. Rate of positioning can be varied up to as high as 70 random, production locations per minute. The worktable is positioned automatically by simultaneous two-dimensional movement, initiated by binary-coded holes punched in tape. Other axes of control can be accommo-

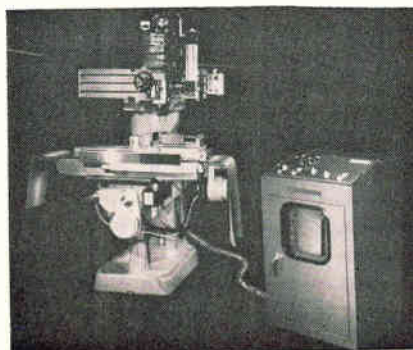

dated. Simplicity of the Centrepoint 200 system permits operation from a 110-v., 60-cycle wall outlet, and both line voltage and plant air supply can vary over a wide range without affecting the accuracy of positioning. Measurement is absolute and is determined from a fixed reference point, which may be floated to any location within the range of the controlled machine. The system utilizes standard EIA code input. The pneumatic tape reader (block type) reads an entire block of information at once, eliminating the need for a storage network. A friction drive feeds the tape smoothly through the reader head. A magnetic clamp holds the tape in reading position, while a safety interlock prevents errors in tape positioning during reading. Since there are neither sprockets nor reading contacts to wear and tear holes, the original tape may be run for thousands of production operations, regardless of application or cyclic rate.

Center Circuits, Inc., 1101 N. Atherton St., State College, Pa. [422]

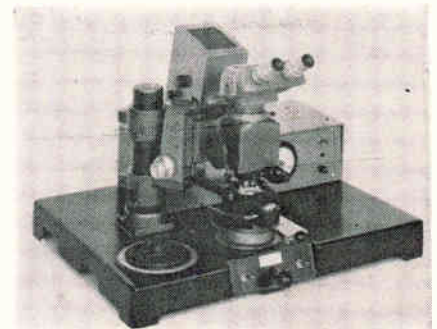

### Exposure station for processing wafers

An optical alignment and exposure station, model 2005, has been designed for processing semiconductor material and thin films. This is a high-speed version of the model 2001. The new machine has improved optics, high-speed alignment chuck and dual-stage vacuum lock positioning. Field tests indicate production rates of 20 seconds per wafer.

Micro Tech Mfg., Inc., 1246A Birchwood Dr., Sunnyvale, Calif. [423]

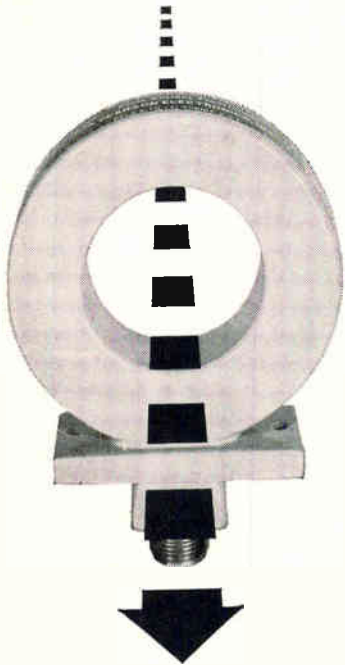

### Wide Band, Precision CURRENT MONITOR

With a Pearson current monitor and an oscilloscope, you can precisely measure ac and pulse currents from milliamps to thousands of amperes, in any conductor or beam of charged particles, at any voltage level up to a million volts, at frequencies up to 35 mc or down to 1 cps.

The monitor is completely isolated, physically and electrically, from the circuit. It is a current transformer capable of highly precise measurement of both amplitude and waveshape. The one shown above, for example, offers high accuracy in output amplitude (+1%, -0%), 1 cps to 35 mc bandwidth, fast rise time (20 nanoseconds), and low droop (0.5% per millisecond).

Whether you want to install a Pearson current monitor around a conductor or a klystron, or measure the beam current in a particle accelerator, it's likely that one of our off-the-shelf models (ranging from 1/2" to 10 3/4" in ID) will do the job. If not, we'll make one that does. Send us your name and you'll have data sheets in a few days.

**PEARSON ELECTRONICS INC**  
4007 Transport St., Palo Alto, California

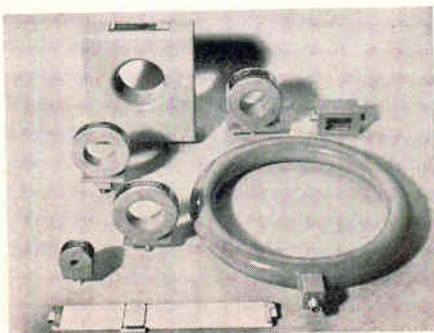

## New Materials

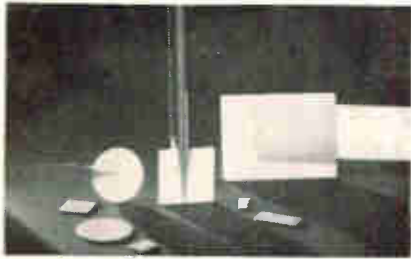

### Alumina substrates are press-finished

A new line of alumina substrates are pressed to final size with precise control over dimension and surface finish. "As pressed" surfaces of  $20 \mu$  in. rms and less have been attained without grinding. Absence of pits, voids and chips is due to development of new alumina bodies, with both 96% and 98% alumina content, which have outstanding flow characteristics. The improved bodies along with advanced pressing methods insure a product with the usual high purity alumina characteristics, high thermal conductivity, high resistivity, and chemical inertness, with surface quality tailored for circuit deposition methods. An improvement over tape extrusion methods, the new products require none of the plasticizers common to this process.

Carborundum Co., Niagara Falls, N.Y. [411]

### Ferrite materials cut tuned-circuit size

Three new ferrite materials—TC-3, -4 and -6—offer a low and linear change of inductance over a broad range of temperatures and frequencies. The LTC ferrites are also said to provide exceptional stability with time, high Q, high initial permeability and low losses. In resonant circuit applications, the inductance value of TC3, -4 or -6 is predictable at a particular temperature. Therefore, changes in reactance and inductance can be compensated for with a mating capacitor of equal but opposite temperature coefficient. The new

ferrites offer optimum performance here. Primary applications for TC-3, -4 and -6 are found when the temperature coefficient over a range of temperatures from approximately  $-55^{\circ}\text{C}$  to  $+85^{\circ}\text{C}$  becomes important—along with the requirement for minimum volume and weight of overall assembly. A good example is the Micromodule Program. In this application, I-f transformers must be kept to a cube of less than  $\frac{1}{4}$  in. square with maximum attainable inductance and Q over a temperature range from  $-65^{\circ}\text{C}$  up to  $+125^{\circ}\text{C}$ . Another prime application requiring miniaturization and temperature coefficient advantages is mobile military communications equipment.

Indiana General Corp., Electronics/Ferrites division, Keasbey, N.J. [412]



### Permanent magnet alloy features high energy

A ductile permanent magnet alloy, platinum-cobalt, can be used for periodic focusing of traveling-wave tubes in areas where compactness and high field strength are of prime importance. It consists of 77% platinum and 23% cobalt by weight. It is readily machinable before final heat treatment, permitting many shapes and sizes. Platinum-cobalt is a nonoriented material, its magnetic properties being the same in all directions. At least 25,000 oersteds are required to fully magnetize the material. Typical residual induction,  $B_r$ , is 6,400 gauss; coercive force,  $H_c$ , is 4,300 oersteds; maximum energy product  $B_a H_a$ , 9.0; peak magnetizing force, 25,000 oersteds; density, 15.70 kilogauss. The Arnold Engineering Co., Marengo, Ill. [413]

## SIDE-LOOKING RADAR SYSTEMS ANALYSTS

New programs at HUGHES are generating opportunities for Systems Analysts experienced in high-resolution data gathering, data transfer and data processing systems. Openings exist for Systems Engineers, Mathematicians and Physicists qualified in synthetic array radars, optical, and other data collection systems (IR, Electro-Optical, SIGINT and others). Assignments include:

**Senior Systems Scientist** with 20 years' electronic systems experience—at least 10 years relevant to side-looking radar systems. Applicants will be considered for important program management responsibilities. M. S. or Ph. D. degree required.

**Senior Systems Analysts** with 10 years' electronic systems experience—at least 5 years relevant to high-resolution systems pre-design and evaluation. Applicants will be considered for assignments in concept formulation; single and multi-sensor applications; data transmission, processing and interpretation; systems integration and performance evaluation. M. S. or Ph. D. required.

**Systems Analysts** with 5 years' experience in: detection of signals in noise, optimum filter theory, non-linear signal processing, information theory, MTI and doppler systems analysis. B. S. or M. S. required.

Please airmail your resume to:

**MR. ROBERT A. MARTIN**  
Head of Employment  
Hughes Aerospace Divisions  
11940 W. Jefferson Blvd.  
Culver City 88, California

Creating a new world with electronics

**HUGHES**

HUGHES AIRCRAFT COMPANY  
AEROSPACE DIVISIONS

U. S. CITIZENSHIP REQUIRED  
An equal opportunity employer.

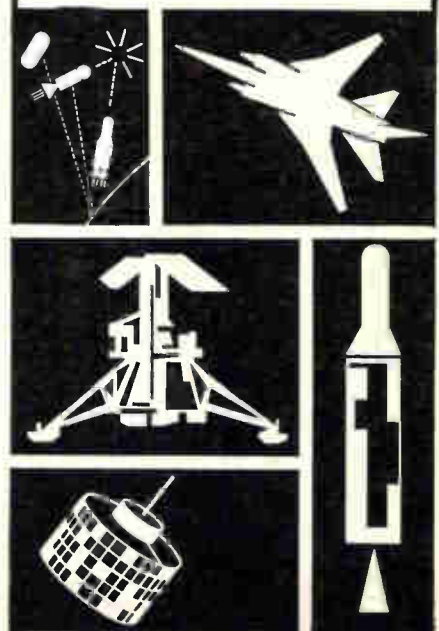

## New Literature

**Germanium digital modules** Packard Bell Computer, 2700 Fairview St., Santa Ana, Calif., 92705. An expanded line of germanium digital modules is covered in a newly-published 40-page catalog. Circle 451 on reader service card

**Facilities brochure** Geodynamics, Inc., 813 North Royal St., Alexandria, Va. 22313, announces publication of a new facilities brochure describing its specialization in contract R&E services in earth sciences, physics and engineering. [452]

**Voltage-variable capacitors** Philco Corp., Lansdale, Pa. A 12-page brochure entitled "Voltage-Variable Capacitor Guide for Communications Circuit Designers" is available. [453]

**Component assembly tools** Philip Fishman Co., 7 Cameron St., Wellesley 8, Mass. A series of tools designed for miniature and subminiature parts handling, potting and encapsulating is explained in four bulletins. [454]

**Subminiature switches** Micro Switch, Freeport, Ill. Data sheet 180b, supplemental to catalog 63 covering small basic switches, describes the new, 10-ampere capacity subminiature 41SM series switches. [455]

**Pressure switches** Metals & Controls Inc., a corporate division of Texas Instruments, Inc., 34 Forest St., Attleboro, Mass. A special fact file, CP-5, compares performance of nine common pressure-switch types. [456]

**Coil winding machines** Geo. Stevens Mfg. Co., Inc., 6001 No. Keystone Ave., Chicago, Ill. 60646. Comprehensive 64-page catalog No. 65 covers a complete line of coil winding machines. [457]

**Temperature conversion chart** Temtech, 2202 S. Wright St., Santa Ana, Calif. 92705. A new chart in circular graph form is now available for temperature conversion. [458]

**Focus coils** Sperry Electro Devices Laboratory, Great Neck, N.Y., has prepared an authoritative booklet describing electromagnetic focus coils and their applications. [459]

**Silicone products chart** Emerson & Cuming, Inc., Canton, Mass. A handy quick reference chart for notebook or wall mounting describes the company's silicone rubber products. [460]

**Plasma diagnostics** TRG Inc., 400 Border St., East Boston 28, Mass. A brochure entitled "Plasma Diagnostics with Millimeter Waves" presents a technical discussion of typical experimental microwave set-ups for studying plasma properties. [461]

**Resistors** RCL Electronics, One Hixon Place, Maplewood, N.J., has published a catalog listing a complete line of resistors and their specifications. [462]

**Dry reed switches** Automatic Electric Co., Northlake, Ill. 60164. A 20-page catalog on dry reed switches is entitled "AE Correeds . . . Specification and Application Data." [463]

**Latching relays** Branson Corp., 41 S. Jefferson Road, Whippany, N.J., announces a two-page catalog sheet describing its new type LS magnetic latching relay. [464]

**Recording wave analyzer** General Radio Co., West Concord, Mass. Volume 38, No. 4 of "The Experimenter" contains an article on the type 1900-A versatile wave analyzer. [465]

**Coil cores** Ferroxcube Corp. of America, Saugerties, N.Y. Comprehensive design information relating to the application of ferromagnetic core materials in power-carrying coils is contained in bulletin 130. [466]

**Core memory systems** Decisional Control Associates, Inc., 1590 Monrovia Ave., Newport Beach, Calif. A 4-page bulletin contains a detailed description of the new VersaLogic 2- $\mu$ sec and 5- $\mu$ sec core memory systems. [467]

**Miniature blower** Rotron Mfg. Co., Inc., Woodstock, N.Y., has released bulletin G-3310 on the Nugget blower that consumes only 7 w at 3,200 rpm and may be operated in any position. [468]

**High-purity and precious metals** Leytess Metal & Chemical Corp., 500 Fifth Ave., New York 36, N.Y., offers a 30-page catalog describing its line of ultra-high-purity and precious metals, as well as its scrap purchasing facilities. [469]

**Zener diodes** TRW Semiconductors Inc., 14520 Aviation Blvd., Lawndale, Calif. Bulletin 122-264 is a 20-page catalog describing nearly 500 Zener diode types and variations. [470]

**Telemetry discriminator** Airpax Electronics Inc., Fort Lauderdale, Fla. Bulletin F-112/A describes the salient features of the FDS4/A bandswitching frequency discriminator. [471]

**Ceramic capacitors** Hi-Q Division, Aero-vox Corp., Olean, N.Y., has available a 40-page reference catalog of ceramic capacitors for industrial and high reliability applications. [472]

**Hall effect multiplier** Helipot Division of Beckman Instruments, Inc., 2500 Harbor Blvd., Fullerton, Calif. Data sheet 64974 describes the new Halleflex model 707 multiplier. [473]

**Electronic gaging system** The Lufkin Rule Co., Saginaw, Mich. A 16-page catalog introduces the Mezurtron system and describes the electronic console, gage heads and universal stand that are its components. [474]

**Logic elements** Intercontinental Instruments Inc., 123 Gazza Blvd., Farmingdale, N.Y. A catalog describes a line of 3-Mc and 10-Mc germanium and silicon NAND logic elements. [475]

**Tubular capacitors** Gulton Industries, Inc., 212 Durham Ave., Metuchen, N.J. A line of miniature tubular ceramic capacitors with capacitance values to 0.1 $\mu$ f is detailed in bulletin H14. [476]

**Sonic energy cleaners** The Bendix Corp., Pioneer-Central Division, Davenport, Iowa, has available an 8-page technical booklet on design parameters for ultrasonic cleaners. [477]

**Microcircuits** Amelco Semiconductor, 1300 Terra Bella Ave., Mountain View, Calif. New data on microcircuits—dual two input gate, dual three input gate, four input gate, five input gate and full shift register elements—are included in an 8-page folder. [478]

**Magnetic shields** Magnetic Shield Division, Perfection Mica Co., 1322 N. Elston Ave., Chicago, Ill. 60622. Data sheet 169 describes non-shock sensitive Co-Netic magnetic shields with minimal retentivity designed to reduce magnetic radiation from switches. [479]

**Brazing alloys** Western Gold and Platinum Co., 525 Harbor Blvd., Belmont, Calif., offers a brochure outlining the advantages of its vacuum-processed oxide-free brazing alloys. [480]

**Precision potentiometers** Markite Corp., 155 Waverly Place, New York 10014. A condensed catalog on conductive-plastic, infinite resolution precision potentiometers lists complete Slimline specifications. [481]

**Balanced modulators** Spectran Electronics Corp., 146 Main St., Maynard, Mass. Catalog sheet 31507 lists specifications for nine low-cost balanced modulators for use below 30 Mc. [482]

**Power systems** Astronetic Research, Inc., Milford Road, Nashua, N.H., has published a bulletin describing special purpose power systems for aircraft, rockets, balloons, and satellites. [483]

**Tape transport hub** Potter Instrument Co., Inc., 151 Sunnyside Blvd., Plainview, N.Y. A product data sheet describes a Quick-Lock hub which reduces loading time of computer tape handlers by 80% over conventional hubs. [484]

**Noise-loading test set** Republic Aviation Corp., Farmingdale, L.I., N.Y. A catalog sheet illustrates and describes a noise-loading test set for 100-Mc bandwidth intermodulation tests. [485]

## New Books

### Nuclear particle detectors

Semiconductor particle detectors.  
J.M. Taylor. Butterworths, Inc.,  
Washington, 1963, 194 pp. \$8.25

Colonel Taylor presents a state-of-the-art review of the theory and application of solid state physics for nuclear particle detection. After a thorough introductory account of semiconductor physics, he describes the three main types of particle counters: diffused junction, surface barrier and lithium ion drift. The discussion of these counters covers the physics of the semiconductor detector, factors governing their properties and the methods of manufacture and employment.

The chapters on solid state physics are designed to state the background to particle detection problems. Complications have been omitted where possible and the limited mathematical treatment is sometimes non-rigorous.

The design and production of the three main types of detectors are described. Examples of their employment and the results achieved are given. The last third of the book covers the electronic instrumentation used with detectors, and the problem of electrical noise. Recent developments on ohmic contacts, thin detectors, lithium ion drift counters and time resolutions are presented. An appendix contains nomographs for barrier layers in silicon and germanium.

Gus Tirellis

### How lasers work

The story of the laser.  
John M. Carroll. E.P. Dutton & Co.,  
New York, 1964, 181 pp. \$3.95

Written in popular language and directed at the intelligent layman and science student, this up-to-date account of the laser field by the managing editor of Electronics gives the laser's brief history, describes how different types of lasers work, and lists current projected laser applications. One chapter gives information on how a laser can be built at home.

In addition to its popular ap-

proach, the volume includes a large amount of information, is well illustrated, has a detailed index and carries a sizable bibliography that will serve as a guide to further study of the laser, a fascinating invention whose potential impact on technology ranks with that of De Forest's Audion tube and Shockley's transistor.

### Systems theory

Views on general systems theory;  
Proceedings of the second on systems  
symposium at Case Institute of  
Technology. M.D. Mesarovic, editor.  
John Wiley & Sons, New York,  
1964, 178 pp. \$9.50

As Dr. Simon Ramo pointed out recently, the human community is engaged in a race of "systems engineering versus the rapidly increasing complexity of our growing technological civilization." Systems science, still in its infancy, is an interdisciplinary—or rather super-disciplinary—attempt to develop a general basic theory that would make it possible to understand, correlate and control the increasing number of scientific and other systems man has to content with.

The seventeen papers from the symposium represent a cross-section of contemporary expert opinion on the sought-for general theory. Some contributors argue that a general theory should not yet be formalized, others attempt to formulate such a theory, and still others have intermediate viewpoints. Definitely worth reading are Dr. Mesarovic's paper on "Foundations for a General Systems Theory" and the provocative remarks on the systems theory's basic philosophy by Kenneth Boulding, Hilary Putnam and W. Ross Ashby.

As to what a system is, there appears to be a certain amount of disagreement. Professor Boulding puts it this way.

According to Mesarovic  
A set of proper statements which  
Has mastered, in well-ordered schools  
A set of transformation rules  
Which rules in turn have rules to twist 'em  
Deserves the name of general system.

McGRAW-HILL  
BOOKS

Just Published

### NONLINEAR-MAGNETIC CONTROL DEVICES

By W. A. GEYGER

*U. S. Naval Ordnance Laboratory*  
Treats the basic principles, characteristics, and applications of nonlinear-magnetic control devices. A wide range of these devices is discussed, such as ferroresonant circuits, magnetic frequency multipliers, switching-transistor magnetic-core multivibrators, flux-gate magnetometers, and combinations of magnetic-core arrangements with various types of semiconductor devices (transistors, silicon controlled rectifiers, etc.). Magnetic amplifiers are also described. Many recent advances are covered, including counting reactors and timers; magnetic frequency doublers; and others. 375 pp., 135 illus., \$12.50. Payable \$6.50 in 10 days, and \$6 in one month.

### INTRODUCTION TO PLASMA PHYSICS

Just Out. Introduces the physical and mathematical concepts of plasma physics, and its applications to radio propagation, astrophysics, power generation, microwave amplification, and other areas. By M. Uman, Univ. of Arizona, 256 pp., illus., \$10.00

### OPTIMIZATION THEORY AND THE DESIGN OF FEEDBACK CONTROL SYSTEMS

Just Out. A comprehensive treatment of the mathematical properties of optimization theory that are pertinent to establishing design principles for feedback control systems. By C. W. Merriam III, Gen. Elec. Research Lab., 424 pp., illus., \$14.00

### REPORTS, TECHNICAL WRITING AND SPECIFICATIONS

Just Out. Presents principles of technical writing basic to any communication situation. Shows each step necessary to give the reader the answers he wants in fewest possible words. By H. K. Glidden, Univ. of Utah, 300 pp., \$5.95

10 DAYS' FREE EXAMINATION  
Convenient Mail Service  
Direct from McGRAW-HILL

McGraw-Hill Book Co., L-6-1  
327 W. 41st St., New York, N. Y. 10036  
Send me book(s) checked below for 10 days on approval. In 10 days I will remit for book(s) I keep plus few cents for delivery costs, and return unwanted book(s) postpaid. (If you remit with coupon, plus local tax, we pay delivery costs—full refund and return privilege.)  
 Geyger—Nonlinear-Mag. Contrl. Devices, \$12.50  
 Uman—Introduction to Plasma Physics, \$10.00  
 Merriam—Optimization Theory & the Design of Feedback Contrl. Sys., \$14.00  
 Glidden—Repts., Tech. Writ. & Specs., \$5.95  
Name .....  
Address ..... Zip .....  
City ..... State ..... Code .....  
Company .....  
Position .....  
For price and terms outside U.S.  
write McGraw-Hill Int'l., N. Y. 10036 L-6-1

## SENIOR MANAGEMENT POSITION FOR SPACE SYSTEMS COMMUNICATIONS

This position will involve the direction of a group concerned with developing the state-of-the-art in communications systems for future spacecraft.

A thorough understanding of the fundamentals of communications systems and a detailed familiarity with the capabilities of communications systems components are required. In addition, systems engineering and hardware experience would be helpful. Specific experience in such areas as command & control systems, telemetry systems, secure systems, high processing gain systems, high data rate systems and satellite relay systems, would be most pertinent.

Since the position is so directly concerned with the development of the state-of-the-art, an open minded and imaginative approach is of critical importance. A personality which would assure acceptance in contract proposals is a consideration.

Requirements include: M.S. or Ph.D. degree from an accredited university, U.S. citizenship and 12 years' experience.

For additional details about this exceptionally challenging opportunity, please airmail your resume to:

**MR. ROBERT A. MARTIN**  
Head of Employment  
**HUGHES Aerospace Divisions**  
11940 W. Jefferson Blvd.  
Culver City 89, Calif.

*Creating a new world with electronics*

**HUGHES**

HUGHES AIRCRAFT COMPANY  
AEROSPACE DIVISIONS

An equal opportunity employer

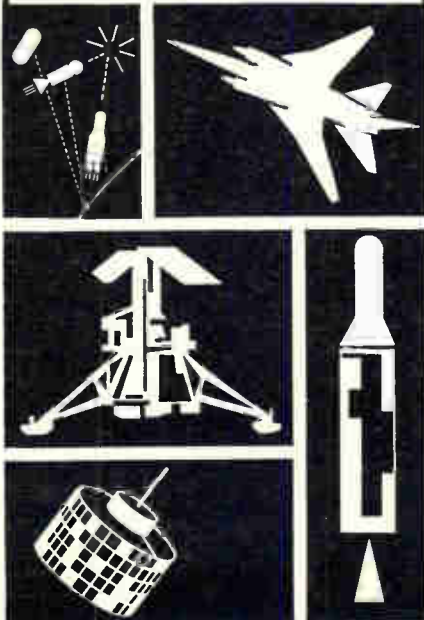

## Technical Abstracts

### Molded memory array

An approach toward batch-fabricated ferrite memory planes: devices' performance and array characteristics.\*  
R.F. Elfant, K.R. Grebe and W.A. Crapo,  
International Business Machines Corp.,  
Yorktown Heights, N.Y.

An approach toward fabricated ferrite memory planes: fabrication and yield.  
J.M. Brownlow, E.A. Bartkus and O.A. Gutwin, International Business Machines Corp., Yorktown Heights, N.Y.

An experimental new molding process forms a miniature memory plane containing thousands of storage cells. The technique is one approach to fabricating ultralarge memories for computers. The array is called Flute, from the flute-like appearance of the individual memory elements. Each storage cell in this memory can store or release information in 100 nanoseconds; a density of 2,000 storage cells per square inch has been achieved in an array containing 15,000 cells. Much higher densities are believed possible.

A magnetic ferrite material is molded in a single step in the form of many tiny tubes over a mesh of fine wires. The finished memory array consists of parallel ferrite tubes held together by a set of wires, called bit lines, intersecting the tubes at right angles. Each tube contains a wire, called a word line, running along its axis.

The array is fabricated by sandwiching a grid of word and bit lines between halves of a matching groove mold, prefilled with a mixture of ferrite and thermosetting binder. After a curing cycle, the array is self-supporting and can be removed from the mold and sintered, a process that burns away the organic binder and leaves a binder-free ceramic ferrite structure.

The Flute array is well adapted to batch fabrication because imperfections in individual element, due to the molding or sintering, may be compensated for by including spare elements in each array, then disconnecting faulty elements and wiring in the spare tubes.

The magnetization direction of the ferrite material above a bit-

and word-line intersection rotate simultaneously when a pulse is applied to the lines. Because the components rotate in unison, this is a fast-switching mechanism. In conventional core-memory devices, the process is sequential.

### Wire memories

Woven thin-film wire memories.\*  
H. Maeda and A. Matsushita. Toko  
Radio Coil Laboratories Ltd.,  
Tokyo, Japan.

The authors have confirmed that by using fine conductors electroplated with a magnetic thin film, very high speed memories can be produced. The processed wire acts as a composite drive-current conductor and storage element. High sense outputs are produced with very low information currents. The high resistance to disturbance shows great promise for the element's use in contemplated nondestructive readout memories.

The basic weave consists of straight horizontal wires that are plated thin-film lines for the digit drive, and vertical interwoven insulated wires for the word-drive line. Digit current  $I_D$ , flowing in the thin-film wire will magnetize it circumferentially in the  $+H$  or  $-H$  direction, depending on the polarity. Word-drive current  $I_W$  flowing in the insulated wire will magnetize the digit wire at right angles to the easy axis, resulting in magnetization  $H_T$ , altering its B-H characteristics. This memory is used to read out the word current, and the induced voltage will be positive or negative, as initially magnetized. The output voltage is put to use in the binary form for memory purposes.

The fine wires for the digit and word lines make possible a very high density weave. The digit wires can be laid 10 to 15 strands per centimeter (25 to 38 per inch).

With good working values of  $I_D$  at 50 ma and  $I_W$  at 0.5 a, the rise time for  $I_W$  was 50 nanoseconds; if shortened to 20 nanoseconds, the outputs would be increased and the switching speed reduced from 80 to 40 nanoseconds.

In one of the test runs, on a one-



shot write-in of information. 1.8 billion ( $1.8 \times 10^9$ ) disturb pulses (6 hours at 2-microsecond pulse time) were applied to adjacent addresses. At the end of this period the readout on the original information showed no deterioration. With  $I_D$  at 50 ma. a recommended value for operation on the present memories, the digit wires will be in a state of magnetization for perfect write-ins. For this condition, a large number of disturbs, one million or more, by  $I_D$  and  $I_W$  with amplitudes 20% or more than the rated values, will not cause abnormal operation in this region.

Presented at the IEEE international conference on nonlinear magnetics (Intermag), April 6-8, 1964, Washington.

### Diffusion discrepancies

Impurities of diffusion in silicon.  
A.M. Smith, R.P. Donovan.  
Research Triangle Institute,  
Durham, N.C.

It has been known for some time that impurities diffused into silicon do not always follow the complementary error function distribution. Large discrepancies have been found between the predicted junction depth and the actual depth. Diffusion coefficients with background doping also have been found to vary widely, especially for shallow diffusions.

This paper lists the experimentally determined values of the diffusion coefficients of 28 impurities in silicon. It also solves Fick's second law of diffusion for several boundary conditions. These solutions are found to coincide with the measured data only under certain conditions.

The value of the diffusion coefficient can be influenced by the concentration of background impurities and of diffusion impurities. The authors illustrate this influence with data from diffusions with boron and phosphorous. They describe some practical diffusion processes, emphasizing methods of open-tube diffusion with boron and phosphorus. They also discuss the capabilities and limitations of various diffusion processes.

The authors suggest future work to assess the relative merits of the various diffusion systems and to permit continuous monitoring for fine control, which is not now pos-



90% of all Japanese ITV cameras use COSMICAR lenses.

- 12.5mm f/1.4
  - 12.5mm f/1.9
  - 25. mm f/1.4
  - 25. mm f/1.9
  - 50. mm f/1.4
  - 50. mm f/1.9
  - 75. mm f/1.4
  - 75. mm f/1.9
  - 150. mm f/4.5
- All available in C-mount



For further details, write today:

**ICHIZUKA OPTICAL CO., LTD.**

2-568, SHIMOOCHIAI, SHINJUKU-KU, TOKYO CABLE ADDRESS: "MOVIEKINO TOKYO"

Circle 205 on reader service card

## COMINCO

*clip and save*

HIGH PURITY METALS  
AVAILABLE FORMS

Product	ALUMINUM	ANTIMONY	ARSENIC	BISMUTH	CADMIUM	GOLD	INDIUM	LEAD	SILVER	TIN	ZINC
BARS	✓	✓	✓	✓	✓	✓	✓	✓	✓	✓	✓
SHEETS	✓				✓	✓	✓	✓	✓	✓	✓
WIRE	✓						✓	✓		✓	✓
POWDER		✓	✓	✓	✓	✓	✓	✓	✓	✓	✓
SHOT		✓		✓	✓	✓	✓	✓	✓	✓	✓
ROD	✓			✓	✓		✓	✓	✓	✓	✓
RIBBON							✓	✓			
PRE-FORMS	✓					✓	✓	✓	✓	✓	✓
SALTS					✓		✓				

## COMINCO PRODUCTS, INC.

electronic materials division

933 West Third Avenue, Spokane 4, Washington

Phone Area Code 509 RI 7-7103 • TWX 509 328-1207

3402

# To order reprints

fill in, cut out coupon

below, insert in envelope

and mail to:

Electronics reprint dept.

330 West 42nd Street

New York, N. Y. 10036

## Reprint order form

For listing of reprints available see the reader service card

To help expedite mailing of your reprints please send cash, check or money order with your order.

For reprints of the latest special report:

Digital Instrumentation

Send me ..... reprints of key no. R-53 at 50¢ each.

For reprints of previous special reports fill in below:

Send me ..... reprints of key no.(s) ..... @ ..... ¢ each.

For prices see the reader service card.

\* For orders of bulk reprints of other editorial articles in this issue or past issues:

Send me ..... reprints of page no.(s) ..... of issue dated

..... of article entitled .....

\* Minimum bulk order 100 copies. You will be advised of costs by return mail.

Name .....

Number and Street .....

City, State, Zip code no. ....

sible. This work would include the plotting of distributions of measured diffusion parameters such as junction depth, sheet resistance and surface concentrations for the various diffusion systems.

Presented at the third annual microelectronics symposium sponsored by the St. Louis section of the IEEE, April 13-15, 1964.

## Low-power microcircuits

Minimum-power microelectronic space system. W.W. Gaertner, M. Schuller and H. Foodman. CBS Laboratories, Stamford, Conn.

By establishing the minimum-power concept as the uppermost requirement in systems development, this paper shows how systems are designed to perform not only with minimum power consumption but also with the minimum size and weight of the electronics, power supplies and radiation shields. The concept also gives a clear guideline for the microelectronic technology to be developed. Although the examples for minimum power microelectronics are already well on their way towards acceptance in space systems, major additional advances are anticipated. The fact that it is possible to design and fabricate analog and digital function blocks, subsystems and systems which operate reliably at supply power levels of 0.5 to 10 microwatts per transistor stage, makes available a large amount of logic and analog capability with virtually negligible power and volume requirements. The authors feel that this will have a major impact on the design of future space systems both in the form of redundancy and greatly enlarged information-processing in the vehicle itself. In particular, on-board editing of gathered data will save over-all power requirements by reducing the necessary transmitter power. The authors believe that we are on the threshold of major technological developments such as the construction of systems with a complexity of several hundred transistors on a single piece of silicon, the development of non-volatile semiconductor memory and logic systems and the potential departure from silicon as the host crystal and substrate.

Presented at the international conference and exhibit on aerospace electro-technology, Apr. 19-25, Phoenix.

## QUALIFICATION FORM FOR POSITIONS AVAILABLE

### ATTENTION: ENGINEERS, SCIENTISTS, PHYSICISTS

This Qualification Form is designed to help you advance in the electronics industry. It is unique and compact. Designed with the assistance of professional personnel management, it isolates specific experience in electronics and deals only in essential background information.

The advertisers listed here are seeking professional experience. Fill in the Qualification Form below.

### STRICTLY CONFIDENTIAL

Your Qualification form will be handled as "Strictly Confidential" by Electronics. Our processing system is such that your form will be forwarded within 24 hours to the proper executives in the companies you select. You will be contacted at your home by the interested companies.

### WHAT TO DO

1. Review the positions in the advertisements.
2. Select those for which you qualify.
3. Notice the key numbers.
4. Circle the corresponding key number below the Qualification Form.
5. Fill out the form completely. Please print clearly.
6. Mail to: Classified Advertising Div., Electronics, Box 12, New York, N. Y. 10036.

COMPANY	SEE PAGE	Key #
AEROSPACE PLACEMENT CORP. Phila., Pa.	114	1
ATOMIC PERSONNEL INC. Phila., Pa.	114	2
COLLINS RADIO CO. Cedar Rapids, Iowa	102*	3
GENERAL ELECTRIC CO. Apollo Support Dept. Daytona Beach, Fla.	115	4
GUIDED MISSILES RANGE DIV. PAN AMERICAN WORLD AIRWAYS INC. Patrick Air Force Base, Fla.	165*	5
METALS & CONTROL INC. A CORPORATE DIV. OF TEXAS INSTRUMENTS Attleboro, Mass.	164*	6
NATIONAL SECURITY AGENCY Fort George G. Meade, Md.	12	7
POTOMAC RIVER NAVAL COMMAND US Naval Station Annex Washington D. C. 20390	20	8
U. S. ARMY ENGINEER GEODESY INTELLIGENCE AND MAPPING, RESEARCH AND DEVELOPMENT AGENCY Fort Belvoir, Va.	165*	9

\* These advertisements appeared in the May 18 issue.

(cut here)

## Electronics WEEKLY QUALIFICATION FORM FOR POSITIONS AVAILABLE

(cut here)

(Please type or print clearly. Necessary for reproduction.)

### Personal Background

NAME .....  
HOME ADDRESS .....  
CITY ..... ZONE ..... STATE .....  
HOME TELEPHONE .....

### Education

PROFESSIONAL DEGREE(S) .....  
DATE(S) .....  
UNIVERSITY .....  
MAJORS(S) .....

### FIELDS OF EXPERIENCE (Please Check)

6164

- |  |  |                                       |
|--|--|---------------------------------------|
| <input type="checkbox"/> Aerospace           | <input type="checkbox"/> Fire Control        | <input type="checkbox"/> Radar        |
| <input type="checkbox"/> Antennas            | <input type="checkbox"/> Human Factors       | <input type="checkbox"/> Radio-TV     |
| <input type="checkbox"/> ASW                 | <input type="checkbox"/> Infrared            | <input type="checkbox"/> Simulators   |
| <input type="checkbox"/> Circuits            | <input type="checkbox"/> Instrumentation     | <input type="checkbox"/> Solid State  |
| <input type="checkbox"/> Communications      | <input type="checkbox"/> Medicine            | <input type="checkbox"/> Telemetry    |
| <input type="checkbox"/> Components          | <input type="checkbox"/> Microwave           | <input type="checkbox"/> Transformers |
| <input type="checkbox"/> Computers           | <input type="checkbox"/> Navigation          | <input type="checkbox"/> Other .....  |
| <input type="checkbox"/> ECM                 | <input type="checkbox"/> Operations Research | <input type="checkbox"/> .....        |
| <input type="checkbox"/> Electron Tubes      | <input type="checkbox"/> Optics              | <input type="checkbox"/> .....        |
| <input type="checkbox"/> Engineering Writing | <input type="checkbox"/> Packaging           | <input type="checkbox"/> .....        |

### CATEGORY OF SPECIALIZATION

Please indicate number of months experience on proper lines.

	Technical Experience (Months)	Supervisory Experience (Months)
RESEARCH (pure, fundamental, basic)	.....	.....
RESEARCH (Applied)	.....	.....
SYSTEMS (New Concepts)	.....	.....
DEVELOPMENT (Model)	.....	.....
DESIGN (Product)	.....	.....
MANUFACTURING (Product)	.....	.....
FIELD (Service)	.....	.....
SALES (Proposals & Products)	.....	.....

CIRCLE KEY NUMBERS OF ABOVE COMPANIES' POSITIONS THAT INTEREST YOU

1 2 3 4 5 6 7 8 9 10 11 12 13 14 15

# SEARCHLIGHT SECTION

(Classified Advertising)

BUSINESS OPPORTUNITIES

EQUIPMENT - USED or RESALE

**DONNER SCIENTIFIC CO.** Analogue Computer, Model 3000. Modular mounted with Variable Base Function Generator, Model 3750, Function Multiplier 3731, Problem Board 3034 and Potentiometer Strip 3021, mounted on Floor Base Unit 3016 with Blower Unit ..... **1475.00**

**FXR Power Meter B 831A** with Bolometer N-218A ..... **250.00**

**NARDA Impedance Meter #223** with RF Probe, Model 229 ..... **225.00**

**JERROLD ELECTRONICS** Sweep Frequency Generator, Model 900A with Detector D-50 ..... **575.00**

**KAY ELECTRIC** Vari Sweep, Model IF ..... **450.00**

**PANORAMIC ELECTRONICS** Sonic Spectrum Analyzer, Model LP 1-A ..... **850.00**

**KROHN-HITE** Servo Design Filter, Model 340-A ..... **125.00**

**LAVOIE LABS.** Synchro Scope, Model 239-C ..... **135.00**

**BOGART** Dummy Load, Model 91331 ..... **475.00**

**GENERAL RADIO** Capacitance Bridge, 710 B ..... **125.00**

**AIRBORNE INSTRUMENTS LABS.** Precision Test Receiver Type 130 with 30 MC, IF PRE amp Type B 130 ..... **450.00**

**GENERAL RADIO** Signal Generator, Type 605 B AC Power Supply, same as LP 5 ..... **195.00**

**GENERAL RADIO** Strobotac Model 1531-A ..... **145.00**

All material in excellent condition. All prices F.O.B., San Francisco, Cal., subject to prior sale. Send for Listing and Flyers.

## Marty's Mart

1236 Market St., San Francisco 3, California  
Phone: UNderhill 3-1215

CIRCLE 950 ON READER SERVICE CARD

## V.I.S\* SERVICE

FASTEST TO  
BOTH COASTS

FOR YOUR  
\*VERY IMPORTANT  
SHIPMENTS

**2nd DAY**  
between Chicago—  
Milwaukee and  
Eastern Terminals

**4th DAY**  
between Chicago—  
Milwaukee and West Coast

## LIFSCHULTZ FAST FREIGHT

NEW YORK — CHICAGO — PHILADELPHIA — BOSTON  
HOLYOKE — BALTIMORE — BLOOMFIELD, N. J.  
NEW HAVEN — PROVIDENCE — MILWAUKEE  
LOS ANGELES — SAN FRANCISCO

CIRCLE 951 ON READER SERVICE CARD

## Color DIAL TELEPHONES \$10.95

Factory rebuilt Western Electric in white, beige, ivory, pink, green, or blue. If 4 prong plug is required add \$2.00. Fully guaranteed. Write for free list. All shipments FOB.



**SURPLUS SAVING CENTER**  
Waymart Dept. MH-E 6163 Penna.

CIRCLE 952 ON READER SERVICE CARD

## OVER 2,000,000 RELAYS IN STOCK!

Send for Catalog 55  
**Universal RELAY CORP.**

42 WHITE ST., N. Y. 13, N. Y. • WAlker 5-6900

CIRCLE 953 ON READER SERVICE CARD

## SMALL AD but BIG STOCK

of choice test equipment  
and surplus electronics

Higher Quality—Lower Costs  
Get our advice on your problem

**ENGINEERING ASSOCIATES**

434 Patterson Road — Dayton 19, Ohio

CIRCLE 954 ON READER SERVICE CARD

## ELECTRON TUBES

KLYSTRONS • ATR & TR • MAGNETRONS  
SUBMINIATURES • C.R.T. • T.W.T. • 5000-  
6000 SERIES

• SEND FOR NEW CATALOG A2 •

**A & A ELECTRONICS CORP.**  
1063 PERRY ANNEX  
WHITTIER, CALIF.  
AN 92865 OR 696-7544

CIRCLE 955 ON READER SERVICE CARD

## Exceptional offer for POTENTIOMETERS

We have shipped erroneously one month ago to the Free ZONE of COLON-S.A., 5,000 potentiometers dia. of the case 25mm, 50,000 ohms with switch shafts 1/4" dia.—3" long. We offer the exceptional price of \$140.—per thousand C.I.F. NEW YORK, and guarantee the highest quality available. These potentiometers are of current production.

**SOCIETE INDUSTRIELLE ALFA, S.A.**  
80, rue de la Senne, BRUSSELS—Belgium.  
Phone: 12-67-30 (5 lines). Telex: 02/21.844  
Cable Address RALFA—Brussels.

CIRCLE 956 ON READER SERVICE CARD

**REX**  
Rheostat  
Company

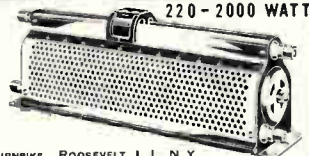

149 BABYLON TURNPIKE ROOSEVELT, L.I., N. Y.

CIRCLE 957 ON READER SERVICE CARD

**RADAR AUTO-TRACK & TELEMETRY ANTENNA PEDESTALS**  
3 & 10 CM. SCR 584 AUTOTRACK RADARS. M-33 RADAR  
TPS-1D SEARCH. APS-45 TPS-10D HT. FINDERS. WX RADARS.  
FPN-320A. APS-10 APS-15B APS-27 (MATH) SEARCH. ■  
APN-102 ODPPLER. DOZENS MORE CARCINOTRONS. PPN'S.  
25-5-1-2-3-6 MEGAWATT PULSE MODULATORS. CAVITIES.  
PULSE TRANSFORMERS. IF STRIPS. WAVEGUIDE. BENDS  
200 MC. 1 KMC. 3 KMC. 6 KMC. 9 KMC. 24 KMC. RF PKGS.

**RADIO RESEARCH INSTRUMENT CO.**  
550 5TH AVE., NEW YORK 36, N. Y. JU 6-4691

CIRCLE 958 ON READER SERVICE CARD

## TRANSISTORS • DIODES

Miniature Components  
Is Our Business. New Surplus Only.  
Small or Large Quantities Available  
**TRANSISTORS UNLIMITED COMPANY**  
462 JERICHO TURNPIKE, MINEOLA, N. Y.  
516-P17-7221

CIRCLE 959 ON READER SERVICE CARD

## "SEARCHLIGHT" IS

## Opportunity Advertising

—to help you get what you want—to  
help you sell what you no longer need.

## Take Advantage Of It

"THINK SEARCHLIGHT FIRST"

For Every Business Want

## EMPLOYMENT OPPORTUNITIES



The advertisements in this section include all employment opportunities — executive, management, technical, selling, office, skilled, manual, etc.

Look in the forward section of the magazine for additional Employment Opportunities advertising.

— RATES —

**DISPLAYED:** The advertising rate is \$52.00 per inch for all advertising appearing on other than a contract basis. Contract rates quoted on request.

An advertising inch is measured 7/8" vertically on a column—3 columns—30 inches to a page.

Subject to Agency Commission.

**UNDISPLAYED:** \$2.70 per line, minimum 3 lines. To figure advance payment count 5 average words as a line.

Box numbers—count as 1 line.

Discount of 10% if full payment is made in advance for 4 consecutive insertions.

Not subject to Agency Commission.



## E. E.'s

for FEE-PAID Positions  
**WRITE US FIRST!**

Use our confidential application for professional, individualized service... a complete national technical employment agency.

**ATOMIC PERSONNEL, INC.**  
Suite 1207L, 1518 Walnut St., Phila. 2, Pa.

New York • Los Angeles • St. Louis • Minneapolis • Atlanta

## EE-MATH

CONFIDENTIAL

SELECTIVE

FEE-PAID

ALL DEGREES

SEND RESUME TO:

## AEROSPACE

PLACEMENT CORPORATION  
P.O. Box 2125 Philadelphia, Pa. 19103

## ATTENTION DISTRIBUTORS!

Write for details on unique, new Circuit Board Cleaner & Deoxidizer. Feature-packed, proven and in demand.

**FREMONT INDUSTRIES**

219 W. 90th St. Mpls. 20, Minn.

CIRCLE 980 ON READER SERVICE CARD

## PROFESSIONAL SERVICES

**GIBBS & HILL, Inc.**

Consulting Engineers

Systems Engineering

Operations Research • Development

Field Studies • Design • Procurement

Power • Transportation • Communications

Water Supply • Waste Treatment

393 Seventh Avenue New York 1, N. Y.

"Put Yourself in the Other Fellow's Place"

TO EMPLOYERS — TO EMPLOYEES

Letters written offering Employment or applying for same are written with the hope of satisfying a current need. An answer, regardless of whether it is favorable or not, is usually expected.

**MR. EMPLOYER,** won't you remove the mystery about the status of an employee's application by acknowledging all applicants and not just the promising candidates.

**MR. EMPLOYER** you, too, can help by acknowledging applications and job offers. This would encourage more companies to answer positions wanted ads in this section. We make this suggestion in a spirit of helpful cooperation between employers and employees.

This section will be the more useful to all as a result of this consideration.

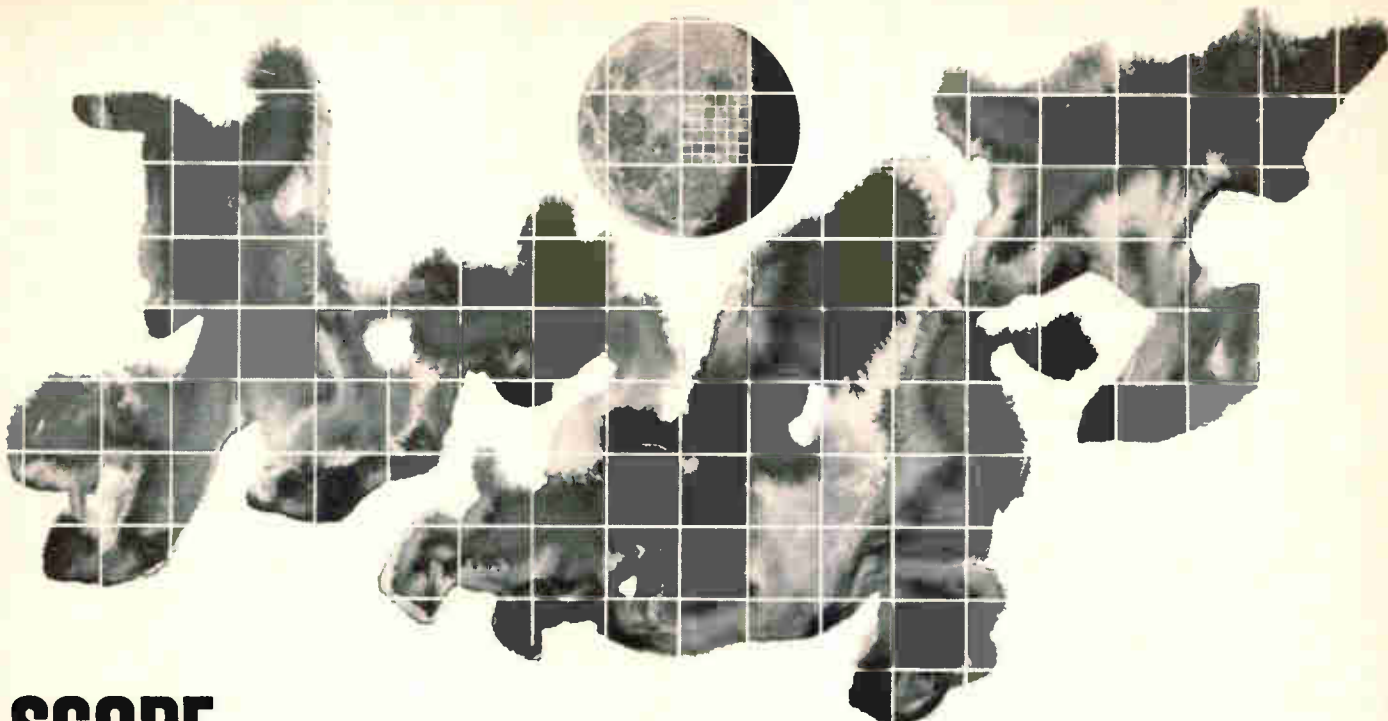

## SCOPE OF OPPORTUNITIES WITH GENERAL ELECTRIC ON THE APOLLO PROGRAM

Specific openings are now available on the Apollo Program with General Electric. All are high in technical content... completely concerned with systems analysis and creative design of various systems for PRE-FLIGHT ACCEPTANCE CHECKOUT EQUIPMENT - SPACECRAFT (PACE - S/C). These are senior positions requiring men who are recognized in their field. There are some openings for men with lesser amounts of experience, but a capability must exist... as the opportunity does...

If you are interested in moving into advanced space fields through assignment now on Apollo with General Electric, you are invited to inquire about current opportunities:

**TELEMETRY INTERFACE DESIGN ENGINEER** Experience in designing interface components between various telemetry equipments and related peripheral equipments, for both airborne and ground telemetry systems.

**TELEMETRY DESIGN ENGINEER - AIRBORNE** Related experience in design of airborne telemetry systems - PCM and general airborne system design required.

**GROUND TELEMETRY SPECIALIST** Experience in the development of operational specifications and parameter requirements of ground telemetry systems.

**TELEMETRY SYSTEMS ENGINEER** Experience in integration and analysis required for a multiple station capability, availability and utilization of both ground telemetry and airborne systems.

**LOGIC DESIGN ENGINEER** Experience in analysis, synthesis and design of digital logic for application to computer directed automatic checkout systems.

**COMPUTER SYSTEMS ENGINEER** Experience in the design and analysis of computer peripheral equipment systems. Must be able to recognize and specify requirements for electrical interface equipment, language, and associated problem areas.

**COMPUTER PROGRAMMER** Experience (with computer programming in a large digital facility) designing computer programs for checkout models and assisting in formulation of analytical models.

**PROGRAMMER ANALYST** Experience in planning, developing, implementing complex programming and real time operating systems using electronic data processing equipment for the analysis in depth, supporting engineering and translation of requirements into computer oriented specifications.

**INSTRUMENTATION SYSTEMS ENGINEER** Experience in airborne or laboratory instrumentation including mathematical modeling for instrumentation, system analysis, accuracy and validity studies for airborne instrumentation systems.

**SYSTEMS ANALYSIS ENGINEER** Experience in the analysis of measurement and telemetry systems, both airborne and ground with particular emphasis on accuracy, validity and techniques for spacecraft sensors and transducers.

**PERIPHERAL EQUIPMENT SPECIALIST** Experience required in specifying computer peripheral equipment and implementing into automatic checkout systems.

**LOGISTICS & MAINTAINABILITY CRITERIA ENGINEER** Experience in establishing the maintenance and logistics operations requirements, preparation of flow diagrams of work requirements and definition of logistics required.

**CHECKOUT ENGINEER** 3 years experience at launch sites preferably with R&D vehicles including a familiarity with digital systems. Additional experience should be in one or more of the following areas: RF systems, switchgear, patching systems design, or ground electric systems.

**RELIABILITY ENGINEER** Reliability experience including failure mode, availability, utilization, and malfunction analysis on airborne telemetry and digital equipment.

**DESIGN ENGINEER** Experience in one or more of the following areas: digital systems/data handling, RF systems, GSE, servo-design, antenna "hat" design, and pad electrical systems.

**ANALOG DISPLAY ENGINEER** Experience in design and development of specifications for analog and alphanumeric display equipment.

**ACTIVITIES ARE WIDE RANGING, PROVIDING BROAD INDIVIDUAL OPPORTUNITIES.**

Your inquiry is invited. Please write, including salary requirements, to: Mr. P. W. Christos, Apollo Support Dept., Rm. 1107-W, G.E. Co., P.O. Box 2500, Daytona Beach, Fla.

**APOLLO SUPPORT DEPT.**  
A Department of the Command Systems Division

**GENERAL  ELECTRIC**

An Equal Opportunity Employer



■ A M P Inc Garceau, Hargrave & McCullough Inc.	22
■ Clairex Corp. S. Paul Sims Co.	101
■ Cominco Products Inc. McKim Adv. Limited	111
■ Communication Electronics Inc. John E. Waterfield/Admasters Adv. Inc.	105
■ Defense Electronics Inc. Compton Jones Associates	9
■ Delco Radio Campbell-Ewald Company	29
■ Dialight Corporation H.J. Gold Co. Adv.	103
■ Di-Arco Corporation Charles E. Brown Adv.	102
■ DuPont de Nemours & Co. Inc., E.I. Batten Barton Durstine & Osborn Inc.	37
■ Durant Manufacturing Co. Keck Advertising Agency	92
Electronic Engineering Co. of California Compton Advertising, Inc.	31
Electronic Research Associates, Inc. Josephson, Cuffari & Co.	95
Fairchild Semiconductor Johnson & Lewis Inc.	14
Fluke Mfg. Co. Inc., John Pollock & Loth, Inc.	11
General Electric Co., Semiconductor Products Dept. Ross Roy Inc.	38
General Electric Co., Silicone Products Dept. Ross Roy Inc.	13
■ Hewlett Packard Co. L.C. Cole Company Inc.	1
■ Howcor Lamination Div. of Howard Industries Inc. Bachrodt, Newell, O'Kane & Gano	94
■ Hughes Aircraft Company Foote, Cone & Belding	82, 107, 110
Ichizuka Optical Co., Ltd. Matsushita Inc.	111
International Rectifier Corp. Communication Associates	34
Kay Electric Company Josephson, Cuffari & Co.	97
■ Kepco Inc. Weiss Advertising	16
■ Kin Tel Div. of Cohu Electronics Erwin Wasey Ruthrauff & Ryan	3rd Cover
Leesona Corp. Chirurg & Cairns, Inc.	21
Machlett Laboratories Inc., The Fuller & Smith & Ross Inc.	8
McGraw-Hill Book Co. Inc.	109

National Security Agency M. Belmont Ver Standing Inc.	12
■ North Atlantic Industries, Inc. Dunwoodie Associates Inc.	87
Pacific Electro Magnetics Co. Inc. Sturges and Associates	96
■ Paktron, Div. Illinois Tool Works Inc. Raymond E. Finn & Associates	88, 89
■ Pearson Electronics Hal Lawrence Inc.	106
Radiation Inc. G.M. Basford Company	27
■ Radio Corporation of America Al Paul Lefton Company	4th Cover
■ Sanborn Co., a Sub. of Hewlett-Packard Culver Adv., Inc.	2
■ Singer Company, Metrics Div. Sprague Electric Company The Harry P. Bridge Co.	7 5, 6, 10
■ Slater Electric Inc. Kane & Light Inc.	82
Texas Instruments Incorporated Industrial Products Group Robinson-Gerrard, Inc.	91
United States Navy M. Belmont Ver Standing Inc.	20
■ United Transformer Corp. Bradley Rosen & Kaus Adv. Inc.	2nd Cover
■ Unirode Corporation Chirurg & Cairns Inc.	19
■ Unitron Inc.	101, 103, 105
West Penn Power Fuller & Smith & Ross Inc.	100
Winston Research Corporation Jordan Advertising Inc.	98, 99

## Advertising sales staff

**James T. Hauptli:** [212] 971-2210  
Advertising sales manager

Atlanta, Ga. 30309: Gus H. Krimmier,  
Michael H. Miller, 1375 Peachtree St. N.E.,  
[404] TR 5-0523

Boston, Mass. 02116: William S. Hodgkinson,  
McGraw-Hill Building, Copley Square,  
[617] CO 2-1160

Chicago, Ill. 60611: Robert M. Denmead,  
Daniel E. Shea, Jr., 645 North Michigan  
Avenue, [312] MO 4-5800

Cleveland, Ohio 44113: Paul T. Fegley, 55  
Public Square, [216] SU 1-7000

Dallas, Texas 75201: Frank Le Beau, The  
Vaughn Building, 1712 Commerce Street,  
[214] RI 7-9721

Denver, Colo. 80202: John W. Patten, David  
M. Watson, Tower Bldg., 1700 Broadway,  
[303] AL 5-2981

Houston, Texas 77025: Kenneth George,  
Prudential Bldg., Halcombe Blvd.,  
[713] RI 8-1280

Los Angeles, Calif. 90017: Ashley P.  
Hartman, John G. Zisch, 1125 W. 6th St.,  
[213] HU 2-5450

New York, N.Y. 10036:  
Donald R. Furth [212] 971-3616  
Donald H. Miller [212] 971-3615  
George F. Werner [212] 971-3617  
500 Fifth Avenue

Philadelphia, Pa. 19103: William J. Boyle,  
Warren H. Gardner, 6 Penn Center Plaza,  
[215] LO 8-6161

San Francisco, Calif. 94111:  
255 California Street,  
[415] DO 2-4600

London W1: Edwin S. Murphy Jr., 34 Dover  
Street

Frankfurt/Main: Matthee Herfurth, 85  
Westendstrasse Phone: 77 26 65 and  
77 30 59

Geneva: Michael R. Zeynel,  
2 Place du Port 244275

Paris VIII: Denis Jacob, 17 Avenue  
Matignon ALMA-0452

Tokyo: Shigeo Chiba, 1, Kotohiracho,  
Shiba, Minato-ku (502) 0656

Osaka: Kazutaka Miura, 163, Umegae-cho,  
Kita-ku [362] 8771

Nagoya: International Media  
Representatives, Yamagishi Bldg.,  
13,2-Chome, Oike-cho Naga-ku

**R.S. Quint:** [212] 971-2335  
General manager  
Electronics Buyers' Guide

**David M. Tempest:** [212] 971-3139  
Promotion manager

**Henry M. Shaw:** [212] 971-3485  
Market research manager

**Richard J. Tomlinson:** [212] 971-3191  
Business manager

**Theodore R. Geipel:** [212] 971-2044  
Production manager

## Classified Advertising

F.J. Eberle, [212] 971-2557 Business Manager	
Employment Opportunities Equipment (Used or Surplus New) For Sale	114-115 114

## Classified Advertisers Index

A & A Electronics Corp.	114
Aerospace Placement Corp.	113
Atomic Personnel Inc.	114
Engineering Associates	114
Fremont Industries Inc.	114
General Electric	115
Lifschultz Fast Freight	114
Marty's Mart	114
■ Radio Research Instrument Co.	114
Rheostat Co., Rex	114
Societe Industrielle Alfa., S.A.	114
Surplus Saving Center	114
Transistors Unlimited Co.	114
■ Universal Relay Corp.	114

■ For more information on complete product line  
see advertisement in the latest Electronics Buyers' Guide

Executive, editorial, circulation and advertising offices: McGraw-Hill Building, 330 West 42nd Street, New York, N.Y., 10036. Telephone Area Code 212-971-3333. Teletype TWX N.Y. 212-640-4646. Cable McGrawhill, N.Y. Officers of the Publications Division: Shelton Fisher, President; Vice Presidents: Joseph H. Allen, Operations; John R. Callahan, Editorial; Ervin E. DeGraff, Circulation; Donald C. McGraw, Jr., Advertising Sales; Angelo R. Venezian, Marketing. Officers of the Corporation: Donald C. McGraw, President; Hugh J. Kelly, Harry L. Waddell, L. Keith Goodrich, Executive Vice Presidents; John L. McGraw, Treasurer; John J. Cooke, Vice President and Secretary. Title R registered U.S. Patent Office; © copyright 1964 by McGraw-Hill, Inc. All rights reserved, including the right to reproduce the contents of this publication, in whole or in part.

Please give complete information

Name \_\_\_\_\_

Company \_\_\_\_\_ Title \_\_\_\_\_

Address \_\_\_\_\_

1	30	59	88	117	146	175	204	233	262	291	320	349	378	407	436	465	494	953
2	31	60	89	118	147	176	205	234	263	292	321	350	379	408	437	466	495	954
3	32	61	90	119	148	177	206	235	264	293	322	351	380	409	438	467	496	955
4	33	62	91	120	149	178	207	236	265	294	323	352	381	410	439	468	497	956
5	34	63	92	121	150	179	208	237	266	295	324	353	382	411	440	469	498	957
6	35	64	93	122	151	180	209	238	267	296	325	354	383	412	441	470	499	958
7	36	65	94	123	152	181	210	239	268	297	326	355	384	413	442	471	500	959
8	37	66	95	124	153	182	211	240	269	298	327	356	385	414	443	472	501	960
9	38	67	96	125	154	183	212	241	270	299	328	357	386	415	444	473	502	961
10	39	68	97	126	155	184	213	242	271	300	329	358	387	416	445	474	503	962
11	40	69	98	127	156	185	214	243	272	301	330	359	388	417	446	475	504	963
12	41	70	99	128	157	186	215	244	273	302	331	360	389	418	447	476	505	964
13	42	71	100	129	158	187	216	245	274	303	332	361	390	419	448	477	506	965
14	43	72	101	130	159	188	217	246	275	304	333	362	391	420	449	478	507	966
15	44	73	102	131	160	189	218	247	276	305	334	363	392	421	450	479	508	967
16	45	74	103	132	161	190	219	248	277	306	335	364	393	422	451	480	509	968
17	46	75	104	133	162	191	220	249	278	307	336	365	394	423	452	481	510	969
18	47	76	105	134	163	192	221	250	279	308	337	366	395	424	453	482	511	970
19	48	77	106	135	164	193	222	251	280	309	338	367	396	425	454	483	512	971
20	49	78	107	136	165	194	223	252	281	310	339	368	397	426	455	484	513	972
21	50	79	108	137	166	195	224	253	282	311	340	369	398	427	456	485	514	973
22	51	80	109	138	167	196	225	254	283	312	341	370	399	428	457	486	515	974
23	52	81	110	139	168	197	226	255	284	313	342	371	400	429	458	487	516	975
24	53	82	111	140	169	198	227	256	285	314	343	372	401	430	459	488	517	976
25	54	83	112	141	170	199	228	257	286	315	344	373	402	431	460	489	900	977
26	55	84	113	142	171	200	229	258	287	316	345	374	403	432	461	490	901	978
27	56	85	114	143	172	201	230	259	288	317	346	375	404	433	462	491	902	979
28	57	86	115	144	173	202	231	260	289	318	347	376	405	434	463	492	951	980
29	58	87	116	145	174	203	232	261	290	319	348	377	406	435	464	493	952	981

For Subscriptions: [Check one box]  New  Renewal

[Check one box] Domestic and Canada  3 years \$12.00  
 1 year \$6.00 Foreign  1 year \$20.00

Product(s) M'd \_\_\_\_\_ services \_\_\_\_\_

# Electronics

## Reader service

Use these handy post cards for more detailed information on: products advertised, new products, new literature.

Circle the number on the Reader Service post card that corresponds to the number at the bottom of the advertisement, new product item, or the literature of the week selection in which you are interested.

Please print clearly. All written information must be legible to be efficiently processed.

All foreign inquiries that cannot reach Electronics before the expiration dates noted on the Reader Service post card, must be mailed directly to the manufacturer. The manufacturer assumes all responsibilities for responding to inquiries. Electronics merely provides and clears requests for information from inquirer to manufacturer.

Correct amount of postage must be affixed for all foreign mailings.

### To subscribe to or to renew Electronics

Fill in the "For Subscriptions" area on the card if you desire to subscribe to or renew your present subscription to Electronics. Send no money. Electronics will bill you at the address indicated on the Reader Service post card.

### Multi-product advertisements

For information on specific items in multi-product advertisements which do not have a specific Reader Service number indicated write directly to manufacturer for information on precise product in which you are interested.

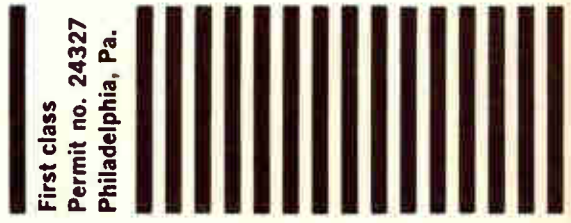

Business reply mail  
No postage stamp necessary if mailed in the United States

Postage will be paid by

**Electronics**  
**Reader service department**  
**Box 8635**  
**Philadelphia, Pa. 19101**

First class  
Permit no. 24327  
Philadelphia, Pa.

**Business reply mail**  
No postage stamp necessary if mailed in the United States

Postage will be paid by

**Electronics  
Reader service department  
Box 8635  
Philadelphia, Pa. 19101**

17 June 1, 1964/card expires August 1, 1964 14

Please give complete information

Name \_\_\_\_\_

Company \_\_\_\_\_ Title \_\_\_\_\_

Address \_\_\_\_\_

1	30	59	88	117	146	175	204	233	262	291	320	349	378	407	436	465	494	953
2	31	60	89	118	147	176	205	234	263	292	321	350	379	408	437	466	495	954
3	32	61	90	119	148	177	206	235	264	293	322	351	380	409	438	467	496	955
4	33	62	91	120	149	178	207	236	265	294	323	352	381	410	439	468	497	956
5	34	63	92	121	150	179	208	237	266	295	324	353	382	411	440	469	498	957
6	35	64	93	122	151	180	209	238	267	296	325	354	383	412	441	470	499	958
7	36	65	94	123	152	181	210	239	268	297	326	355	384	413	442	471	500	959
8	37	66	95	124	153	182	211	240	269	298	327	356	385	414	443	472	501	960
9	38	67	96	125	154	183	212	241	270	299	328	357	386	415	444	473	502	961
10	39	68	97	126	155	184	213	242	271	300	329	358	387	416	445	474	503	962
11	40	69	98	127	156	185	214	243	272	301	330	359	388	417	446	475	504	963
12	41	70	99	128	157	186	215	244	273	302	331	360	389	418	447	476	505	964
13	42	71	100	129	158	187	216	245	274	303	332	361	390	419	448	477	506	965
14	43	72	101	130	159	188	217	246	275	304	333	362	391	420	449	478	507	966
15	44	73	102	131	160	189	218	247	276	305	334	363	392	421	450	479	508	967
16	45	74	103	132	161	190	219	248	277	306	335	364	393	422	451	480	509	968
17	46	75	104	133	162	191	220	249	278	307	336	365	394	423	452	481	510	969
18	47	76	105	134	163	192	221	250	279	308	337	366	395	424	453	482	511	970
19	48	77	106	135	164	193	222	251	280	309	338	367	396	425	454	483	512	971
20	49	78	107	136	165	194	223	252	281	310	339	368	397	426	455	484	513	972
21	50	79	108	137	166	195	224	253	282	311	340	369	398	427	456	485	514	973
22	51	80	109	138	167	196	225	254	283	312	341	370	399	428	457	486	515	974
23	52	81	110	139	168	197	226	255	284	313	342	371	400	429	458	487	516	975
24	53	82	111	140	169	198	227	256	285	314	343	372	401	430	459	488	517	976
25	54	83	112	141	170	199	228	257	286	315	344	373	402	431	460	489	900	977
26	55	84	113	142	171	200	229	258	287	316	345	374	403	432	461	490	901	978
27	56	85	114	143	172	201	230	259	288	317	346	375	404	433	462	491	902	979
28	57	86	115	144	173	202	231	260	289	318	347	376	405	434	463	492	951	980
29	58	87	116	145	174	203	232	261	290	319	348	377	406	435	464	493	952	981

For Subscriptions: [Check one box]  New  Renewal

[Check one box] Domestic and Canada  3 years \$12.00

1 year \$6.00 Foreign  1 year \$20.00

Product/Mail

services

# Reprint service

All Electronics editorial matter available in reprint form:

For reprints of special reports and feature articles with prices for varying quantities, see list below. Send your order to Electronics Reprint Department at address indicated below. To expedite mailing of your order for single reprints please send cash, check or money order with your order.

Bulk reprints of editorial matter can be ordered from current or past issues. The minimum quantity is 100 copies. The higher the quantity ordered, the more economical the cost per copy. Prices quoted on request.

Bulk reprints can be made up with the cover of the magazine on the front page, and your advertising message on the back page. To order reprints or for further information, please write to: Electronics Reprint Department, 330 West 42nd Street, New York, N. Y. 10036. Telephone: Area code 212 971-3140.

## You may order the following reprints by key number using order form on page 112

- Key no. R-55 Voltage Variable Capacitors Used For Electronic Tuning, 9 pages. 35¢
- Key no. R-54 Resistors Improve Performance While Their Size Decreases, 6 pages. 25¢
- Key no. R-53 Digital Instrumentation, 16 pages. 50¢
- Key no. R-52 Advanced technology: Evaluating light demodulators, 8 pages. 35¢
- Key no. R-51 Medical electronics: Electronic weapon against cancer, 5 pages. 25¢
- Key no. R-50 Electronics in Israel 7 pages. 25¢
- Key no. R-49 Injection Laser Systems, [2 part series] 12 pages. 35¢
- Key no. R-48 Modern Electronic Packaging, 16 pages. 50¢
- Key no. R-47 Electronic Markets New Directions 1963-64-67, 20 pages. 50¢
- Key no. R-46 Annual Editorial Index, Vol. 36, January 4 to December 27, 1963, 16 pages. 25¢
- Key no. R-45 Today's Semiconductors, 24 pages. 50¢
- Key no. R-42 Materials for Space Age Electronics, 16 pages. 50¢
- Key no. R-41 Telemetry Today, 7 pages. 25¢
- Key no. R-40 Tunnel Diodes, [4 part series] 26 pages. 50¢
- Key no. R-39 Radio Frequency Interference, 24 pages. 50¢
- Key no. R-38 Family Tree of Semiconductors, 6 pages. 50¢
- Key no. R-31 1962 Electromagnetic Spectrum Chart 8 pages. \$1.00
- Key no. R-30 Graphical Symbols for Electronics Diagrams, 4 pages. \$1.00
- Key no. R-29 Bionics, [4 part series] 19 pages. \$1.00
- Key no. R-26 Lasers Devices and Systems, [4 part series] 23 pages. \$1.00
- Key no. R-19 Medical Electronics, [7 part series] 42 pages. \$1.50
- Key no. R-43 The Impact of Microelectronics, 120 pages. (Proceedings of the June 26-27, 1963 conference on the Impact of Microelectronics. \$3.50 per copy.)



# KIN TEL introduces FIVE precision test instruments IN ONE

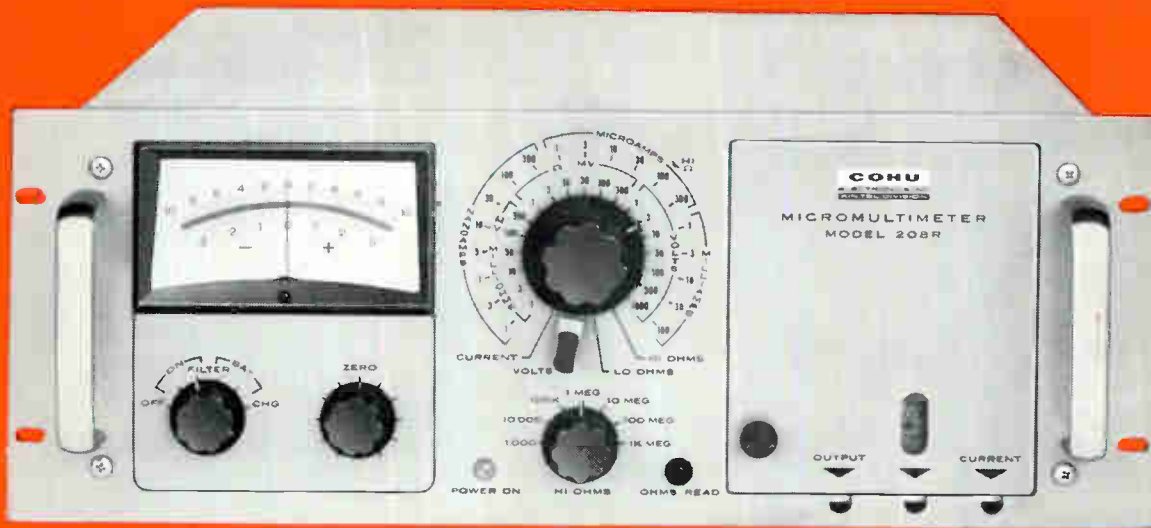

**Model 208R Micromultimeter**

AT LESS COST, IN FAR LESS SPACE than closest equivalent instrumentation, Model 208R combines performance not previously available in one device.

HIGH RANGES AND LOW RANGES in one instrument give you the advantages of a DC microvoltmeter with ranges to 1000 volts, a microammeter, a wide range ohmmeter, an electronic galvanometer, and a narrow-band DC amplifier.

CHECK THESE FEATURES. Available for rack mounting or bench-top use, Model 208R operates from 115 or 230 volts, 50 to 400 cps, and from optional nickel-cadmium battery pack. Circuitry is solid state, chopper stabilized. Electrical output is suitable for driving a strip-chart recorder. Extra-long probes are stored on plug-in holders in a handy internal compartment, accessible from the front panel. \$1495. Additional export charge.

#### CHECK THIS PERFORMANCE.

	VOLTAGE MEASUREMENTS	CURRENT MEASUREMENTS	RESISTANCE MEASUREMENTS
SCALES (full scale indication)	$10^{-6}$ to $10^3$ volts DC	$10^{-10}$ to $10^{-1}$ ampere DC	$10^{-3}$ to $10^9$ ohms
ACCURACY	1% of full scale or $10^{-7}$ volt, whichever is greater	1% of full scale or $10^{-11}$ ampere, whichever is greater	$10^{-3}$ to $10^8$ ohms scales: 2% of full scale or $10^{-4}$ ohm, whichever is greater $10^9$ ohms scale: 3% of full scale
INPUT RESISTANCE	$10^{-5}$ to $10^3$ volt scales: • $10^8$ ohms $10^{-6}$ and $3 \times 10^{-6}$ volt scales: • $10^7$ and $3 \times 10^7$ ohms	$10^{-10}$ to $10^{-5}$ ampere scales: $10^4$ ohms $3 \times 10^{-5}$ and $10^{-1}$ ampere scales: $10^1$ ohms	N/A
DRIFT (30 minute warmup)	$< 2 \times 10^{-7}$ volts	$< 2 \times 10^{-11}$ amperes	$< 2 \times 10^{-4}$ ohms



5725 Kearny Villa Road, San Diego, California 92112 - Phone 277-6700 (Area Code 714)

Visit our Booth 1017 at WESCON, Sports Arena, Los Angeles, August 25-28

# "Quick Heat" for "Push-to-Talk" Equipment



Hollow, cylindrical design of the RCA-8462 mesh filament offers greater emitting surface as well as built-in mechanical strength.



## New RCA-8462 with Mesh Filament Achieves 70% of Rated Power Output Within 1 Second

A warm-up time of less than 1 second *without external circuitry* provides the new RCA-8462 conduction-cooled Beam Power Tube with a heating capability so quick that standby power can be eliminated in "push-to-talk" emergency equipment. In a suitably-designed filament over-voltage pulse ("hot-shot") circuit, this ceramic-metal tube achieves warm-up in less than 100 milliseconds.

The thermal capabilities of the mechanically-rugged mesh filament were proved in a 100,000-cycle "hot-shot" test. The only commercially available "Quick-Heat" tube in its frequency-power range, the RCA-8462 is designed for use in inexpensive, 11-pin

sockets answering many communications needs.

In CW operation with a plate voltage of only 700 volts, the RCA-8462 provides 110 watts power output at 50 Mc, 105 watts at 175 Mc, and 85 watts at 470 Mc. It can be used as an RF amplifier, oscillator, regulator, distributed amplifier, or linear RF amplifier in both mobile and stationary equipment.

For more information on the RCA-8462 and other RCA tubes with ceramic-metal construction, see your RCA Representative. For technical data, write: Commercial Engineering, Section F-19-DE-1, RCA Electronic Components and Devices, Harrison, N. J.

AVAILABLE THROUGH YOUR AUTHORIZED RCA INDUSTRIAL TUBE DISTRIBUTOR



The Most Trusted Name in Electronics