

The first fossil free-living late instar larva of Strepsiptera (Insecta)

HANS POHL^{*,1}, JÖRG U. HAMMEL^{1,2}, ADRIAN RICHTER¹ & ROLF G. BEUTEL¹

¹Institut für Zoologie und Evolutionsforschung, Friedrich-Schiller-Universität Jena, Erbertstrasse 1, 07743 Jena, Germany; Hans Pohl* [hans.pohl@uni-jena.de]; Rolf G. Beutel [rolf.beutel@uni-jena.de]; Adrian Richter [adrian.richter@uni-jena.de] — ²Institute of Materials Research, Helmholtz-Zentrum Geesthacht, Outstation at DESY, Notkestrasse 85, 22607 Hamburg, Germany; Jörg U. Hammel [joerg.hammel@hzg.de] — * Corresponding author

Accepted on March 15, 2019.

Published online at www.senckenberg.de/arthropod-systematics on May 17, 2019.

Published in print on June 03, 2019.

Editors in charge: André Nel & Klaus-Dieter Klass.

Abstract. A fossil Cenozoic late instar strepsipteran larva is described and evaluated phylogenetically. The single specimen is embedded in Eocene Baltic amber. The short antennal buds, mandibles not intercrossing in the midline, unsegmented tarsi, and the elongated slender claws clearly indicate that it is not an adult female but a late larval instar. The low number of ommatidia of the compound eyes strongly suggests that it is an immature female. Besides this, wing buds are missing in contrast to male puparia of Mengenillidae. Phylogenetic analyses of characters of female late instar larvae indicate that the species belongs to the stem group of Strepsiptera. The presence of distinctly developed mouthparts and legs show that the larva does not belong to Stylopodia. The presence of a distinct clypeolabral suture, a large labrum, and claws which are elongated but not filiform exclude it from crown group Strepsiptera. It is likely that it is a female larva of the extinct genus †*Mengea*, which is only known from Eocene Baltic amber. Small size excludes an assignment to †*Protaxenos*, which is known from the same period. Characters of the fossil entered in a comprehensive matrix assuming that the larva belongs to †*Mengea* confirm a sistergroup relationship between the fossil described here and extant Strepsiptera.

Key words. Strepsiptera, late instar larva, Baltic amber.

1. Introduction

The endoparasitic Strepsiptera are one of the most highly specialized groups of insects (e.g., ULRICH 1927a; KINZELBACH 1971a; KATHIRITHAMBY 1991; POHL & BEUTEL 2008). The phylogenetic position was recently clarified (NIEHUIS et al. 2012; BOUSSAU et al. 2014; MISOF et al. 2014; PETERS et al. 2014) after long and intensive controversies (KRISTENSEN 1999: “The Strepsiptera problem”; e.g., WHITING et al. 1997; WHEELER et al. 2001; BEUTEL & POHL 2006a; POHL & BEUTEL 2013). The group is characterised by a strongly modified morphology in all life stages and a highly unusual life cycle and reproductive biology (e.g., ULRICH 1927a; KINZELBACH 1971a,b; KATHIRITHAMBY 1991; POHL 2000; POHL & BEUTEL 2005, 2008; PEINERT et al. 2016). The knowledge of the morphology of both sexes and different life stages has greatly increased in the last years (e.g., BEUTEL et al. 2005; POHL & BEUTEL 2005; BEUTEL & POHL

2006b; BRAVO et al. 2009; OSSWALD et al. 2010; POHL et al. 2010; KNAUTHE et al. 2016; LÖWE et al. 2016; RICHTER et al. 2017), and also the available developmental (FRAULOB et al. 2015) and paleontological data (e.g., KINZELBACH & POHL 1994; POHL & KINZELBACH 1995, 2001; GRIMALDI et al. 2005; POHL et al. 2005; KATHIRITHAMBY & HENDERICKX 2008; POHL et al. 2010; HÜNEFELD et al. 2011; HENDERICKX et al. 2013; WANG et al. 2015; ANTELL & KATHIRITHAMBY 2016; ENGEL et al. 2016; POHL et al. 2018). However, information on the anatomy of later instar larvae is still very scarce for extant taxa (e.g. SILVESTRI 1941a,b; KINZELBACH 1971a,b), and fossil later instars were completely unknown so far. Consequently, the finding of a well-preserved final stage of an “ancestral” species closes an important gap of information. The specimen embedded in a piece of Middle Eocene Baltic amber (Lutetian, minimum

age approx. 42–49 Ma, probable maximum age 54 Ma (ODIN & LUTERBACHER 1992; RITZKOWSKI 1997) was examined with modern techniques and described. Observed morphological data were evaluated cladistically, mainly using data from previous studies, especially POHL & BEUTEL (2005). Possible affinities with stem group strepsipterans from the same deposits, i.e. †*Mengea tertiaria* (Menge, 1866), †*M. menzei* Kulicka, 1979 (Mengeidae) (ULRICH 1927b; POHL et al. 2010) and †*Protoxenos janzeni* Pohl, Beutel & Kinzelbach, 2005 (Protoxenidae) (POHL et al. 2005), are discussed.

2. Materials and methods

2.1. Material

The single specimen embedded in a piece of Baltic amber was purchased from Marius Veta (Palanga, Lithuania). The size of the roughly pentagonal piece is approximately $24 \times 15 \times 3$ mm. The precise locality is unknown. Apart from a stellate trichome and small particles of debris there are no syninclusions (Fig. 1). The fossil is deposited into the collection of the Phyletisches Museum Jena (Institut für Zoologie und Evolutionsforschung, FSU Jena) with the accession number PMJ Strep 36.

2.2. Specimen imaging

The piece of amber was temporarily mounted on a glass microscope slide with glycerine and covered with a coverslip. A Leica MZ 12.5 compound microscope was used for observations at magnifications up to $100\times$. For overcoming limited depth of field, stacks of several partially focused images were taken in raw format with a Canon Eos 6D digital SLR equipped with a Canon MP-E 65 mm macro lens (Canon, Krefeld, Germany) fitted with a StackShot macro rail (Cognisys, Traverse City, MI, U.S.A.). The specimen was illuminated with two flashlights (Yongnuo Photographic Equipment, Shenzhen, China). The raw images were processed in Adobe Photoshop Lightroom 6 (Adobe Systems Incorporated, San Jose, California, U.S.A.) and saved as tif images. Zerene stacker 1.04 (Zerene Systems LLC, Richland, U.S.A.) was used to fuse the images and Adobe Photoshop CS6 (Adobe Systems Incorporated, San Jose, California, U.S.A.) and Adobe Illustrator CS6 (Adobe Systems Incorporated, San Jose, California, U.S.A.) to arrange the images as plates and for lettering.

2.3. Micro computed tomography (μ CT)

The piece of amber with the fossil late instar larva was scanned using the microtomography endstation of the imaging Beamline P05 (HAIBEL et al. 2010; GREVING et al. 2014; WILDE et al. 2016) operated by the Helmholtz-

Zentrum Geesthacht, Germany, using 20 KeV at the storage ring Petra III at Deutsches Elektronen-Synchrotron DESY, Hamburg, Germany. The projections have been recorded with a slight edge enhancement placing the detector at 10 cm distance to the sample using a custom developed 20 MP CMOS camera system with an effective pixel size of 643 nm in the projection images. For the tomographic scan 4801 projections at equal intervals between 0 and π have been recorded. Tomographic reconstruction has been done using the filtered backprojection algorithm (FBP) implemented in a custom reconstruction pipeline (MOOSMANN et al. 2014) using MATLAB (MathWorks, Natick, MA, U.S.A.) and the Astra Toolbox. For processing the raw projections were binned two times resulting in an effective pixel size of the reconstructed volume of 1.29 μ m.

For comparison, a male puparium of *Eoxenos laboulbenei* Peyerimhoff, 1919 (Mengenillidae) was scanned using a Skyscan 2211 μ CT-Scanner (Bruker, Belgium) at the Max Planck Institut für Menschheitsgeschichte Jena, equipped with a high resolution (4000×2600 pixel) X-ray sensitive CCD camera. A beam strength of 70 kV and 250 μ A was employed. Exposure time was 3.7 s and a pixel size of 1.2 μ m was achieved in a 360° scan with 0.2° rotation steps. Tomographic reconstruction was done using NRecon (Version: 1.7.3.1).

2.4. Computer-based 3D reconstruction

Based on μ CT-image stacks, the fossil late instar larva and the male puparium of *E. laboulbenei* were segmented with Amira 5.6.0 (Thermo Fisher Scientific, Hillsboro, Oregon, U.S.A.). All sections were used and subsequently exported as tif-stacks. The cuticle of the fossil was segmented in areas where it was preserved. In other areas (mainly dorsal side of abdomen) the contour was segmented. The volume rendering (Phong) was performed with VGStudio MAX 2.0 (Volume Graphics, Heidelberg, Germany).

2.5. Description of morphological features and measurements

Morphological features, with the exception of colouration, were observed and described using the volume rendered 3D models. The measurements were conducted with the 2D measurement tool in Amira 5.6.0.

2.6. Phylogenetic analyses

Mesquite 3.51 (MADDISON & MADDISON 2018) was used for entering the data in different matrices. Characters of female and male puparia (partly from POHL & BEUTEL 2005) were alternatively scored for the fossil late instar larva (matrices in electronic supplement files 1, 2). Additionally, the characters of the fossil were entered in

a comprehensive matrix for Strepsiptera (mainly from POHL & BEUTEL 2005) assuming that it is a female late-instar larva of †*Mengea* (S3). Parsimony analyses (all characters with equal weight and unordered) were carried out with NONA (ratchet, 1000 repl.) (GOLOBOFF 1995) and TNT (traditional search, random seed 1, 10 repl., TBR, 10 trees saved per repl.) (GOLOBOFF et al. 2008). Bremer-support values (BREMER 1994) were calculated with NONA. *Sialis* sp. Latreille, 1803 (Sialidae, Megaloptera) and *Hydraena* Kugelann sp., 1794 (Hydraenidae, Coleoptera) were used as outgroup taxa and treated as all other groups in the analysis (simultaneous analysis; NIXON & CARPENTER 1993).

3. Results

3.1. General appearance and preservation

The total length is 4.4 mm and the maximum width of the abdomen (abdominal segment IV) 2.5 mm. The cuticle of most body parts is light brown and apparently weakly sclerotized (Fig. 1). Fields of tubercles are present in middle regions of the tergites and sternites, more distinct on the former than on the latter. The postcephalic body is broad and distinctly flattened. The thorax is slightly bent to the left. A distinct angle is present between the metathorax and abdominal segment I. Compound eyes are present. The legs are distinctly developed. The abdominal segments are laterally explanate.

Soft tissue of the larva is not preserved, which is completely hollow except for small cuticular fragments in the lumen. The cuticle of the ventral side is almost completely preserved, whereas that of the dorsal side of the abdomen is largely decomposed.

3.2. Head

The head is orthognathous and hardly visible in dorsal view, overtopped by the anterior edge of the pronotum (Figs. 3, 4). It is about $1.5 \times$ as wide as long and quadrant-shaped in lateral view. Hemispheric compound eyes are distinctly developed posterolaterally, with a relatively low number of 12 large and closely adjacent ommatidia (left 11 ommatidia, right 13 ommatidia discernible) with round and convex cornea lenses (Fig. 5B,C). Ocelli are absent. Cephalic sutures are not recognizable. A median longitudinal bulge is present and reaches the clypeal edge anteriorly (Fig. 5A). The anterior clypeal edge is rounded, lacking a serration. The vertically oriented large labrum is trapezoidal, with a rounded anterior margin with an indistinct median incision (Fig. 6). It appears slightly asymmetric. It is proximally articulated with the anterior clypeofrontal margin, with a very distinct clypeolabral suture. A mouthfield sclerite is present as a semicircular elevation with a concave anterior margin caudad of the labrum. A mouth opening is not discernible. One-

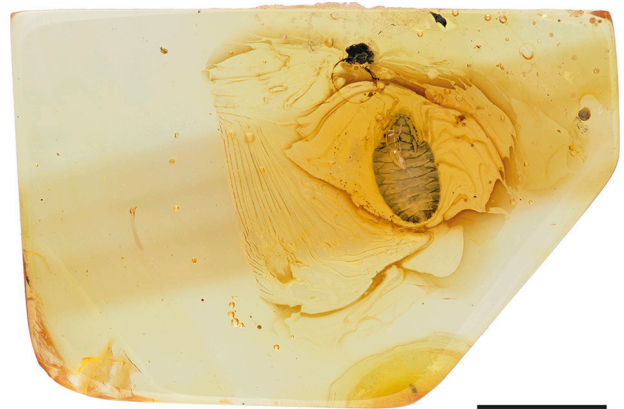

Fig. 1. Piece of Baltic amber containing the strepsipteran late instar larva; diagonal darker stripe caused by X-radiation during scanning; microphotograph. Scale bar = 5 mm.

segmented antennae are present as distinct paired circular and elevated buds anterad the compound eyes on longitudinal bulges (Fig. 5). The well-developed robust mandibles are inserted anterad the anterior clypeofrontal margin and laterad the labrum (Fig. 6). The axis of articulation is oblique and the single apex posteromesally directed. The distal parts are not intercrossing in the sagittal plane. The maxillae are inserted posterior to the mandibles. The short maxillary body is not subdivided into cardo and stipes and endite lobes are absent (Fig. 6). Only a large, spindle-shaped one-segmented palp is distinctly recognizable (Figs. 5B,C, 6), with a longitudinal sensorial groove on its lateral side. Posteriorly, the maxillae are directly adjacent with the prosternum. A labium and tentorial grooves are not recognizable. The ventral side of the head is more than half as long as the prosternum.

3.3. Thorax

The prothorax is the narrowest thoracic segment, anteriorly slightly wider as the posterior cephalic margin and posteriorly more than twice as wide. The margin of the pronotum is evenly rounded anteriorly and laterally, and indistinctly divided into two plates with a weakly sclerotized mesal area on the posterior region (Figs. 2A, 3A). The anterior edge is bent upwards, thus forming a distinct bulge dorsad the posterodorsal region of the head (Fig. 4B,C). The mesothorax is wider than the prothorax and the metathorax is the widest thoracic segment. The tergites are slightly rounded laterally. Their middle region is covered with tubercles (Figs. 2A, 3A). The broad sternites display a pattern of wrinkles, most of them longitudinally arranged. They also bear indistinct and irregular patterns of tubercles, especially on their middle region. Narrow transverse folds are present between the pro- and mesosternum and between the meso- and metasternum. The convex anterior edge of the metathorax forms a shallow anteriorly directed angle, thus covering the median part of the transverse fold. The legs are distinctly developed, inserted ventrolaterally and posteriorly directed, on the left side addressed to the



Fig. 2. Microphotographs of strepsipteran late instar larva in Baltic amber; **A:** dorsal view; **B:** ventral view.

ventral body surface, on the right side ventrally directed with the exception of the foreleg (Figs. 2B, 3B). All legs are divided into five segments (Fig. 7). Pro-, meso-, and metathoracic legs are very similar in size. The proximal coxae, the largest element of the legs, are cup-shaped, widening distally. The barrel-shaped trochanterofemur is the shortest leg segment and is less than half as long as the coxa and less wide. The tibia is almost twice as long as the trochanterofemur and slightly narrower. The tarsus is as

long as the tibia and very slightly narrower. The pretarsal claws are elongate and slender but still robust at the base. Wing Anlagen are completely absent.

3.4. Abdomen

The abdomen is composed of nine segments (Figs. 2–4). It is distinctly wider than the thorax and reaches its maxi-

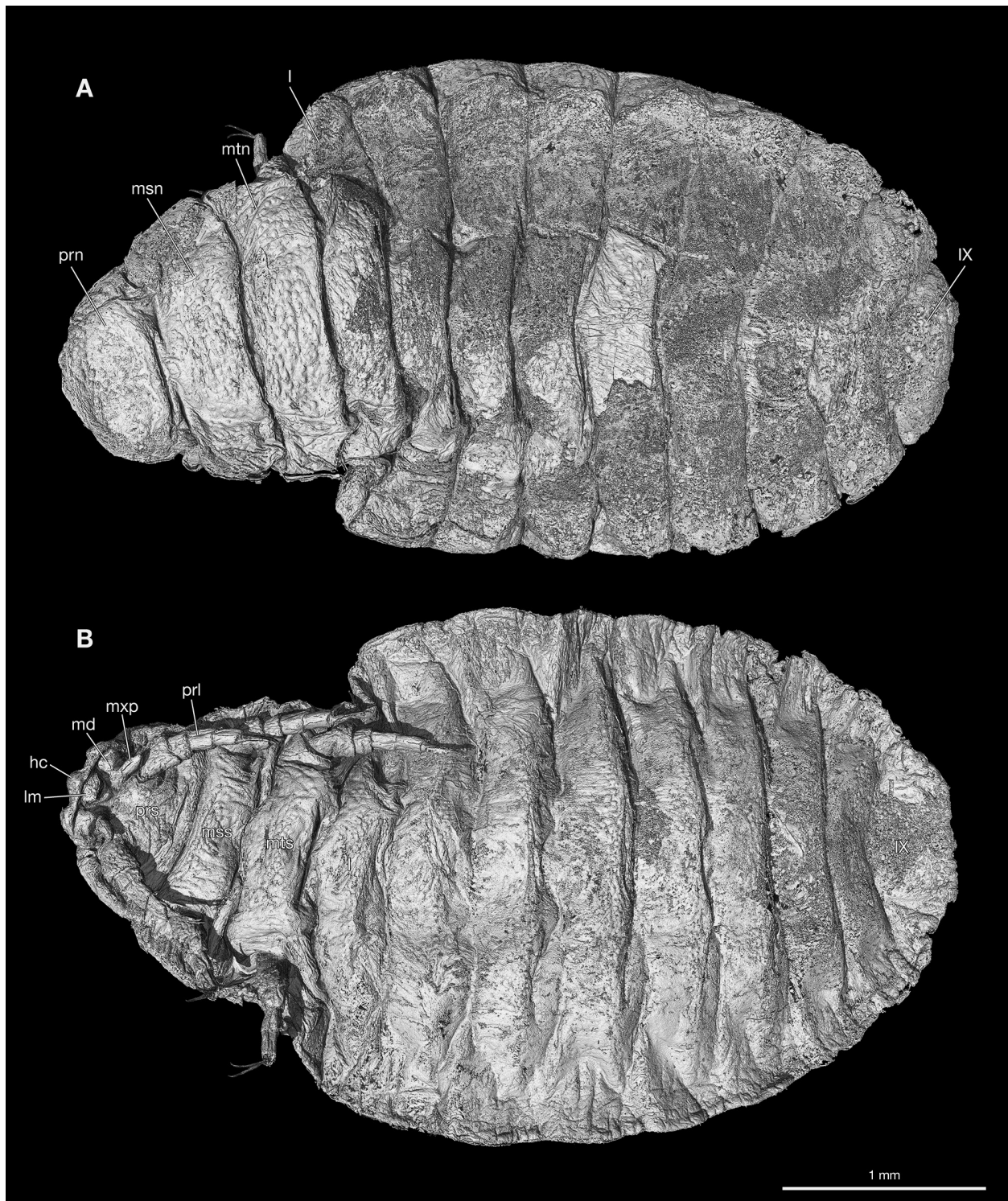

Fig. 3. Volume-rendered 3D micrographs of the strepsipteran late instar larva; **A:** dorsal view; **B:** ventral view. — **Abbreviations:** hc – head capsule; I – abdominal segment I; IX – abdominal segment IX; lm – labrum; md – mandible; msn – mesonotum; mtn – metanotum; mss – mesosternum; mts – metasternum; mxp – maxillary palp; prl – prothoracic leg; prn – pronotum; prs – prosternum.

mum width at segment IV. The lateral margin is evenly rounded and also the lateral edges of the individual tergites I–VIII, more distinctly in the case of the anterior segments. Distinct oblique wrinkles are present on the lateral region of the sternites. Distinct transverse fields of tubercles are present on the posterior sternal halves. Segment I is separated from the metathorax by a distinct

angle resulting in pronounced shoulder region (Figs. 2, 3). The hind margin of segment VIII is very distinctly concave on the dorsal and ventral side. The terminal segment IX is evenly rounded posteriorly, thus forming a nearly semicircular structure. A birth opening is not discernible. Spiracles are present on abdominal tergites I–VII (Fig. 8). Abdominal appendages are completely missing.

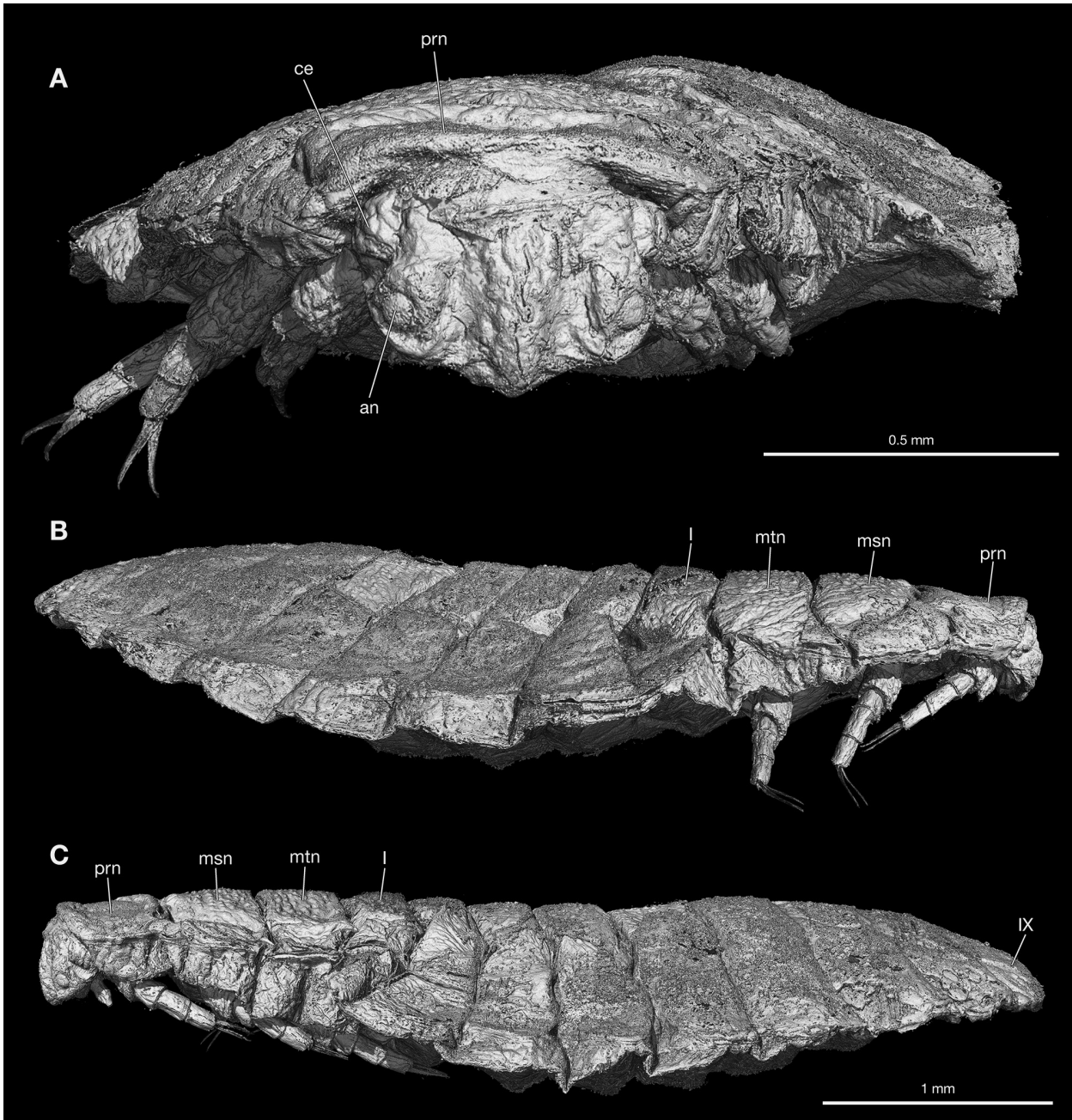

Fig. 4. Volume-rendered 3D micrographs of the late instar larva; **A:** frontal view; **B:** right lateral view; **C:** left lateral view. — **Abbreviations:** an – antenna; ce – compound eye; l – abdominal segment I; IX – abdominal segment IX; msn – mesonotum; mtn – metanotum; prn – pronotum.

3.5. Characters of female late instar larvae/puparium

Characters 99–134 in complete matrix (see electronic supplement file 3); see also (POHL & BEUTEL 2005).

1. **Endoparasitism:** (0) absent; (1) present. Last instar larvae of *Mengenilla* Hofeneder 1910 and *Eoxenos* leave the host completely and form a puparium (e.g. POHL & BEUTEL 2005). Embedding in amber indicates that this also applies to the fossil late instar larva.
2. **Shape of anterior body:** (0) straight; (1) bent backwards towards caudal end of body. Straight in fos-

sil late instar larva and most other groups of Strepsiptera. Bent backwards in Corioxenidae, at least shortly before the body wall of the host is penetrated (KINZELBACH 1971b; POHL & MELBER 1996; POHL & BEUTEL 2005: fig. 26A).

3. **Orientation of abdomen within host:** (0) caudally oriented; (1) cranially oriented. Conform to anterior-posterior orientation of host in Corioxenidae, but oriented in opposite direction in Stylopiformia (KINZELBACH 1971b; POHL & BEUTEL 2005).
4. **Cephalic-prothoracic connection:** (0) head functionally separated from prothorax; (1) head incompletely fused with prothorax; (2) head in-

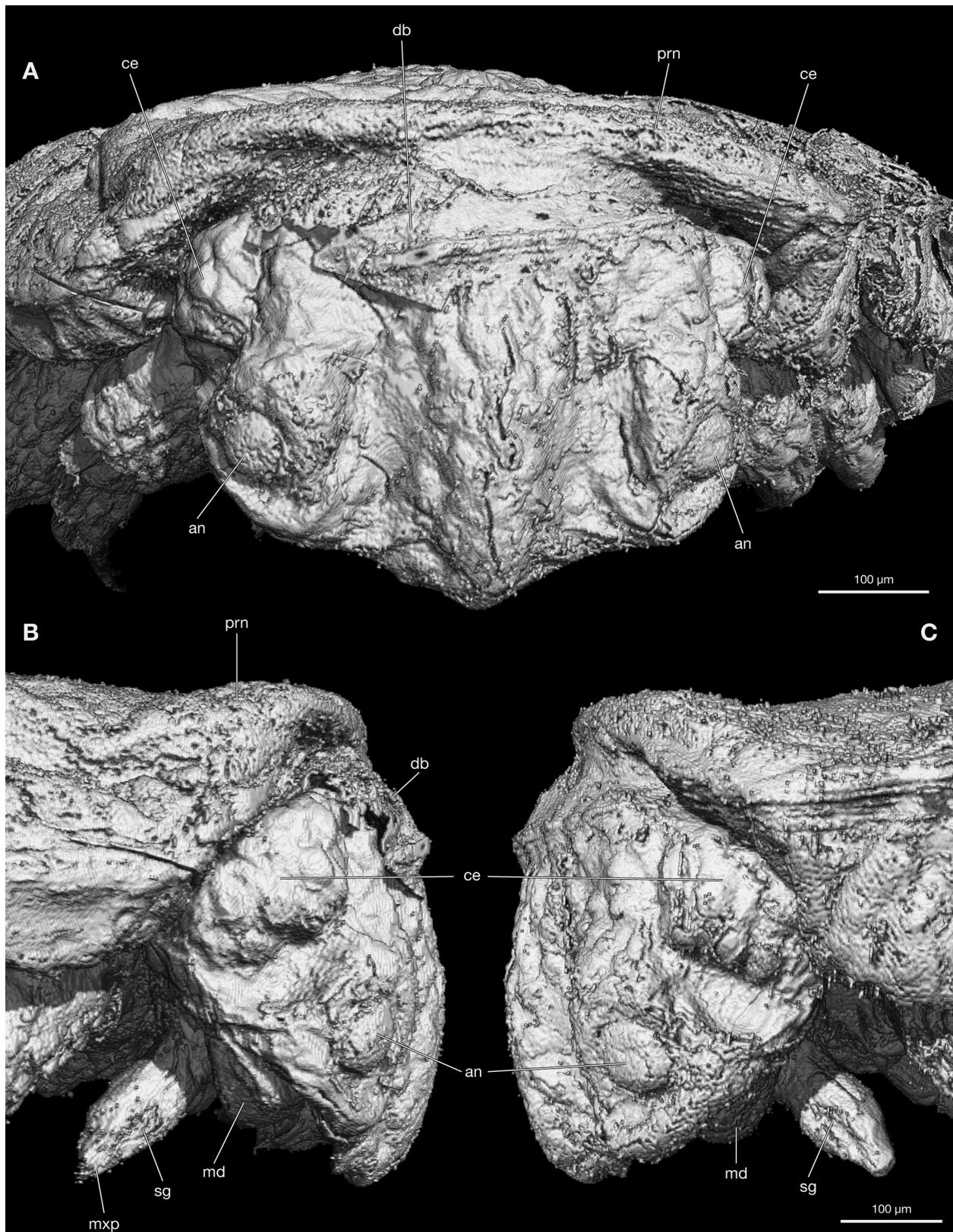

Fig. 5. Volume-rendered 3D micrographs of the head of the late instar larva; **A:** frontal view; **B:** right lateral view; **C:** left lateral view. — **Abbreviations:** an – antenna; ce – compound eye; db – debris; md – mandible; mxp – maxillary palp; prn – pronotum; sg – sensorial groove.

corporated in a functional unit with prothorax. Preserved as separate and functionally independent tagma in fossil late instar larva and in *Eoxenos* and

Mengenilla (POHL & BEUTEL 2005). Incompletely fused with prothorax in Corioxenidae and completely merged in Stylopiformia.

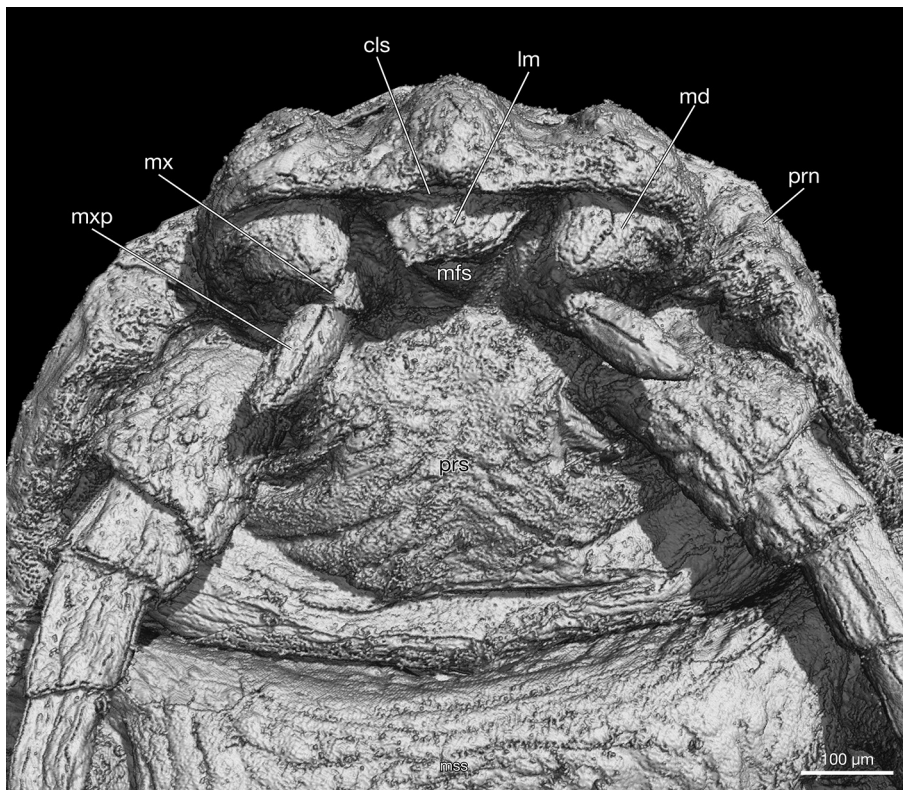

Fig. 6. Volume-rendered 3D micrograph of the head of the late instar larva, anteroventral view. — **Abbreviations:** cls – clypeolabral suture; lm – labrum; md – mandible; mfs – mouthfield sclerite; mss – mesosternum; mx – maxilla; mxp – maxillary palp; prn – pronotum; prs – prosternum.

5. **Orientation of head: (0) orthognathous; (1) subprognathous; (2) prognathous.** Orthognathous in fossil late instar larva and in *Eoxenos* and *Mengenilla*. Prognathous in *Stylopidia* (POHL & BEUTEL 2005).
6. **Y-shaped cephalic ecdysial suture: (0) present; (1) absent.** Absent in fossil late instar larva like in all other groups of Strepsiptera with known terminal instars (POHL & BEUTEL 2005).
7. **Lateral eyes: (0) stemmata; (1) compound eyes; (2) absent.** Stemmata in the outgroup taxa. Distinctly developed compound eyes in the fossil late instar larva like in final instars of Mengenillidae (POHL & BEUTEL 2005). The compound eyes of the prepupal stage distinguish Strepsiptera from all other groups of holometabolous insects (e.g., BEUTEL et al. 2011). The presence is very likely a groundplan feature of the order and the complete loss of lateral eyes an apomorphy of female *Stylopidia*. The comparatively low number of 12 ommatidia suggests that the fossil late instar larva is a female.
8. **Field of sensilla between mandible and the antennal bud: (0) absent; (1) present.** Irregular field of small circular grooves present between mandible and antennal bud in Corioxenidae (POHL & BEUTEL 2005).
9. **Serration on anterior clypeal edge: (0) absent; (1) present.** Serrated edge present in *Eoxenos* and *Mengenilla* but absent in fossil late instar larva.
10. **Labrum: (0) present as a separate structure articulating with clypeus; (1) fused with clypeus or absent.** Large and articulated with the clypeus in fossil late instar larva. Distinctly smaller in final instars of Mengenillidae and Corioxenidae (POHL & BEUTEL 2005: fig. 26C) and fused with the anterior clypeal edge. Absent as a separate cephalic structure in *Stylopidiformia* (POHL & BEUTEL 2005).
11. **Orientation of labrum relative to clypeus, i.e. angle between clypeus and labrum: (0) approx. 0°; (1) approx. 45°; (2) approx. 90°.** Approx. 45° in fossil late instar larva and final larvae of Corioxenidae. Approx. 90° in final instars of Mengenillidae. Not applicable to taxa with state (1) in character 10.
12. **Antenna: (0) present as a prominent structure; (1) completely flat antennal field or absent.** Present as unsegmented rounded bud in fossil late instar larva and final instars of Mengenillidae and Corioxenidae (POHL & BEUTEL 2008: fig. 11D). Absent or completely flat in *Stylopidiformia* (POHL & BEUTEL 2005).
13. **Antennal segmentation: (0) composed of several segments; (1) unsegmented bud.** Generally unsegmented in larvae of Strepsiptera (KINZELBACH 1971a; POHL & BEUTEL 2005: figs. 21C, 24).
14. **Mandible: (0) well-developed; (1) vestigial or absent.** Well-developed in fossil late instar larva and final instars of Mengenillidae and Corioxenidae (POHL & BEUTEL 2005: fig. 26C). Vestigial in *Stylopidiformia* (POHL & BEUTEL 2005: fig. 26D).
15. **Position of primary and secondary mandibular joint: (0) mandibular joints oriented along vertical axis of movement; (1) secondary mandibular joint located mesad of primary joint, axis of movement oblique.** Secondary mandibular joint located mesad of primary joint in fossil late instar larva and final instars of Mengenillidae and Corio-

xenidae, resulting in oblique axis of movement. Axis between both joints vertical in outgroup taxa. Scored as inapplicable for taxa with state (1) of character 14 (vestigial mandible).

16. **Maxillary body: (0) distinct; (1) vestigial or absent.** Distinct in fossil late instar larva and final instars of Mengenillidae and Corioxenidae. Vestigial or completely absent in Stylopiformia (POHL & BEUTEL 2005: fig. 21D–F).
17. **Cardo and stipes: (0) present as distinct maxillary subunits; (1) not present as separate maxillary subunits.** Not present as maxillary subunits in larvae of Strepsiptera.
18. **Galea and lacinia: (0) present; (1) absent.** Always absent in larvae of Strepsiptera.
19. **Size of maxillary palp: (0) normally sized, same diameter as maxillary body; (1) very small or absent.** Normally sized in fossil late instar larvae. Very small in Mengenillidae and absent in Stylopodia.
20. **Segmentation of maxillary palp: (0) with several palpomeres; (1) undivided.** Scored as inapplicable for Stylopodia (POHL & BEUTEL 2005: fig. 21).
21. **Sensorial groove of maxillary palp: (0) present; (1) absent.** Present in fossil late instar larvae but absent in Mengenillidae.
22. **Labium: (0) present; (1) absent.** Absent in strepsipteran immatures.
23. **Length of ventral side of head: (0) > ½ of length of prosternum; (1) ≤ ½ of length of prosternum.** Head on ventral side more than half as long as prosternum in fossil late instar larva. Less than half length of prosternum in 3rd instars of Mengenillidae. Scored as inapplicable for Stylopodia.
24. **Thoracic segments: (0) distinctly separated; (1) largely or completely fused.** Segmental borders distinct in fossil late instar larva like in *Eoxenos* and *Mengenilla* (POHL & BEUTEL 2005: fig. 23). Largely reduced in Stylopodia (POHL & BEUTEL 2005: fig. 21). Indistinct segmental borders preserved in Corioxenidae, Halictophagidae, Stylopidae and Xenidae (scored as 1).
25. **Postcephalic dorsomedian ecdysial line: (0) present; (1) absent.** Absent in fossil larva like in all other groups of Strepsiptera (POHL & BEUTEL 2005), even though a faint dorsomedian furrow may be present in free-living final instars.
26. **Circumferential line of weakness (reduced sclerotization) between head and prothorax: (0) absent; (1) present.** Not visible in fossil late instar larva (scored as ‘?’). Present as line of weakly sclerotized cuticle between head and prothorax in females of Mengenillidae (POHL & BEUTEL 2008; POHL et al. 2012). Head discarded at this line of weakness during hatching of the adult female.
27. **Fields of tubercles on tergites: (0) absent; (1) present.** Fields of tubercles are present in the fossil late instar larva and in final instars of Mengenillidae.
28. **Shape of cephalothorax: (0) dorsoventrally flattened; (1) approximately round in cross-section.**

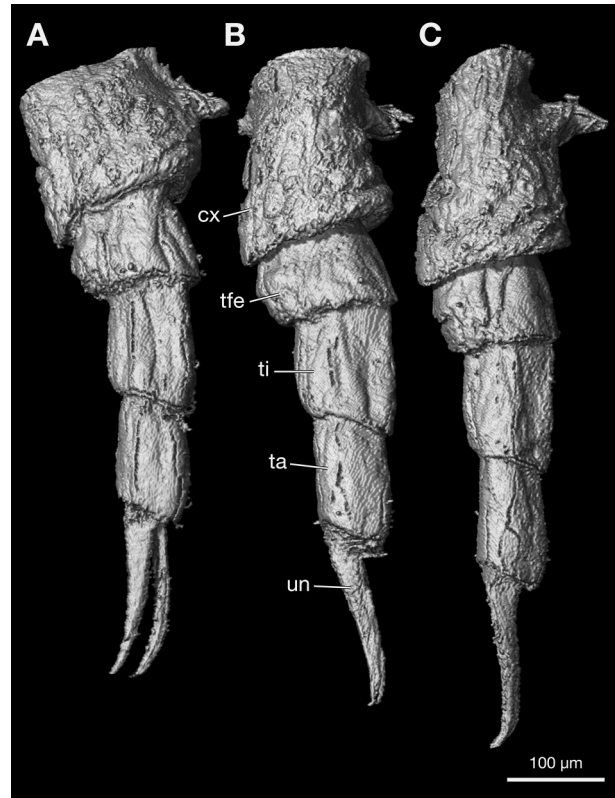

Fig. 7. Volume-rendered 3D micrographs of the left side legs of the late instar larva, ventral view; A: prothoracic leg; B: mesothoracic leg; C: metathoracic leg. — *Abbreviations*: cx – coxa; ta – tarsus; tfe – trochanterofemur; ti – tibia; un – pretarsal claw.

Approximately round in cross section in Myrmecolacidae and Elenchidae (KINZELBACH 1971b; POHL & BEUTEL 2005).

29. **Legs: (0) present; (1) absent.** Present in fossil late instar larva and final instars of Mengenillidae. Absent in Stylopodia.
30. **Leg segmentation: (0) distinctly developed with six segments; (1) five-segmented, with tibiotarsus; (2) five-segmented, with trochanterofemur.** Five-segmented with trochanterofemur in fossil late instar larva and final instars of Mengenillidae. Absent in Stylopodia (scored as inapplicable).
31. **Claws: (0) present; (1) absent.** Present in fossil late instar larva and Mengenillidae. Absent in Stylopodia.
32. **Shape of claws: (0) normally developed, elongated but with robust base; (1) filiform.** Elongated but with robust basal part in fossil late instar larva. Filiform in *Mengenilla* and *Eoxenos* (PARKER & SMITH 1933 1934; SILVESTRI 1943; POHL & BEUTEL 2004; POHL et al. 2012).
33. **Number of pairs of spiracles: (0) eight pairs on segments I–VIII; (1) seven pairs on abdominal segments I–VII; (2) single pair at posterior end of cephalothorax; (3) absent.** Several spiracles in fossil late instar larva and final instars of Mengenillidae. Single spiracle in Stylopodia. Eight pairs in larvae of *Hydraena*. Absent in *Sialis*.

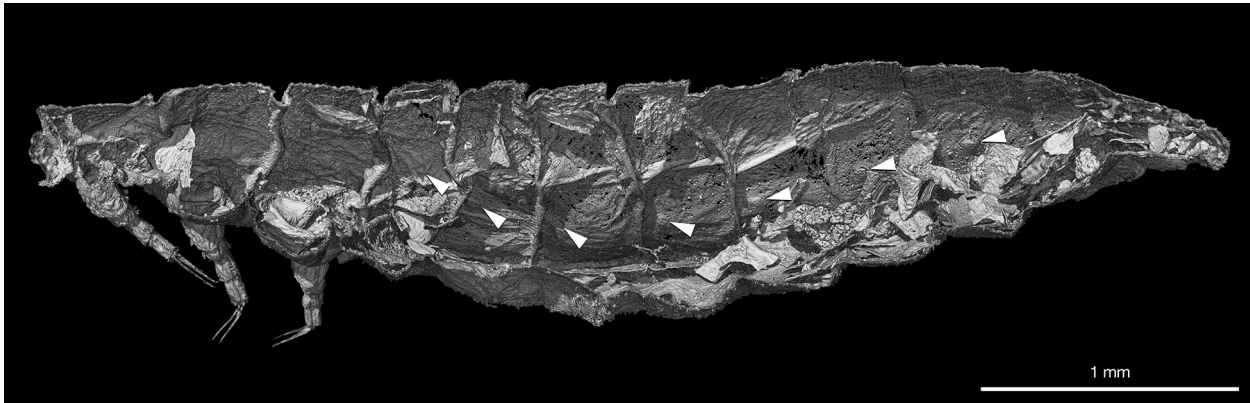

Fig. 8. Volume-rendered 3D micrograph of the late instar larva, slightly paramedian section; white arrows indicate the position of the spiracles.

- 34. Ventrally bent lateral tergal extensions: (0) absent; (1) present.** Tergites laterally explanate in fossil late instar larva. Tergal extensions bent ventrad in puparia of Mengenillidae, resulting in a characteristic tortoise-shaped postcephalic body (e.g., PARKER & SMITH 1933; POHL et al. 2012).
- 35. Delimited flat platform on middle region of abdominal sternites resulting in a tortoise-like pattern: (0) absent; (1) present.** The elevated platform-like middle regions of the abdominal sternites of *Eoxenos* result in a tortoise-like pattern on the ventral side (FRAULOB & POHL 2015). This feature is absent in the fossil late instar larva and in *Mengenilla* (POHL et al. 2012).
- 36. Cuticular thorns: (0) absent; (1) present.** Present in female puparia of Mengenillidae (excl. *Mengenilla moldrzyki* Pohl, Niehuis, Gloyna, Misof & Beutel, 2012) (PARKER & SMITH 1933; SILVESTRI 1943; POHL & BEUTEL 2005, 2008; POHL et al. 2012). Absent in fossil late instar larvae and in Stylopodia.

3.6. Results of the analyses

The fossil is unambiguously placed as sistergroup of monophyletic crown group Strepsiptera (43 steps, CI = 0.97, RI = 0.98; branch support values: †*Mengea* + crown group Strepsiptera 9, crown group Strepsiptera 1, Mengenillidae 5, Stylopodia 4, Corioxenidae 2, Stylopi-formia 3) when only characters of female late instar larvae (36) are scored (File S1, Fig. 10). The same result was obtained with a much less likely interpretation of the larva as male (2 minimum length trees with 37 steps, CI = 0.97, RI = 0.98, see electronic supplement files 2, 4: Fig. S1). Analyses of the matrix with the complete data set (205 characters of males and females and immature stages, 11 minimum length trees with 309 steps, CI = 0.8, RI = 0.9) and the fossil treated as female larva of †*Mengea* also yielded a sister group relationship between this extinct genus and crown group Strepsiptera (electronic supplement files 3, 4: Fig. S2).

4. Discussion

A confirmed 1st instar strepsipteran larvae was recently discovered in Cretaceous Burmese amber (POHL et al. 2018). Another primary larva was described from Eocene brown coal (Geisel Valley, Germany) (HAUPT 1950 [as coccooid 1st instar]; KINZELBACH & LUTZ 1985; POHL 2009). The larva described here is the first fossil late instar of Strepsiptera. Even though the habitus is quite similar to that of extant adult females, several characters unambiguously indicate that it is a late immature stage: the antennae are only present as short unsegmented, rounded buds, the distal parts of the mandibles are not slender and do not intercross in midline, and the tarsi of the short legs are unsegmented. The sex of the late instar larva is difficult to determine, but the comparatively low number of 12 ommatidia and the flattened shape suggests that it is a female. The number of ommatidia in the similarly sized male last instar larvae of *E. laboulbenei* is more than 30, versus 15 in female last instar larvae of the same species (SILVESTRI 1941a). A comparatively high number of 52–56 is also present in male last instar larvae of *Mengenilla chobauti* versus 13–18 in the female (SILVESTRI 1943). Moreover, female last instars of Mengenillidae are distinctly flattened in contrast to the male larvae (SILVESTRI 1941a, 1943; POHL & BEUTEL 2005: figs. 23, 24, 25E). The absence of slightly elevated wing buds is an ambivalent feature (Fig. 9B), even though wings and wing buds are always missing in females. Considering the phylogenetic position of Strepsiptera as sistergroup of Coleoptera (e.g., MISOF et al. 2014; PETERS et al. 2014), it is conceivable that the presence of these shallow elevations in male last instar larvae of *Mengenilla* and *Eoxenos* is a secondary feature and a potential autapomorphy of Mengenillidae. As internal structures are not preserved in the larva, the sex of the specimen cannot be fully confirmed. Consequently, we scored the recognizable morphological features for both female and male larvae (electronic supplement files 1, 2) and analysed both data sets.

Even though the data set of characters of the prepupal larval stage is limited with only 36 characters, the results

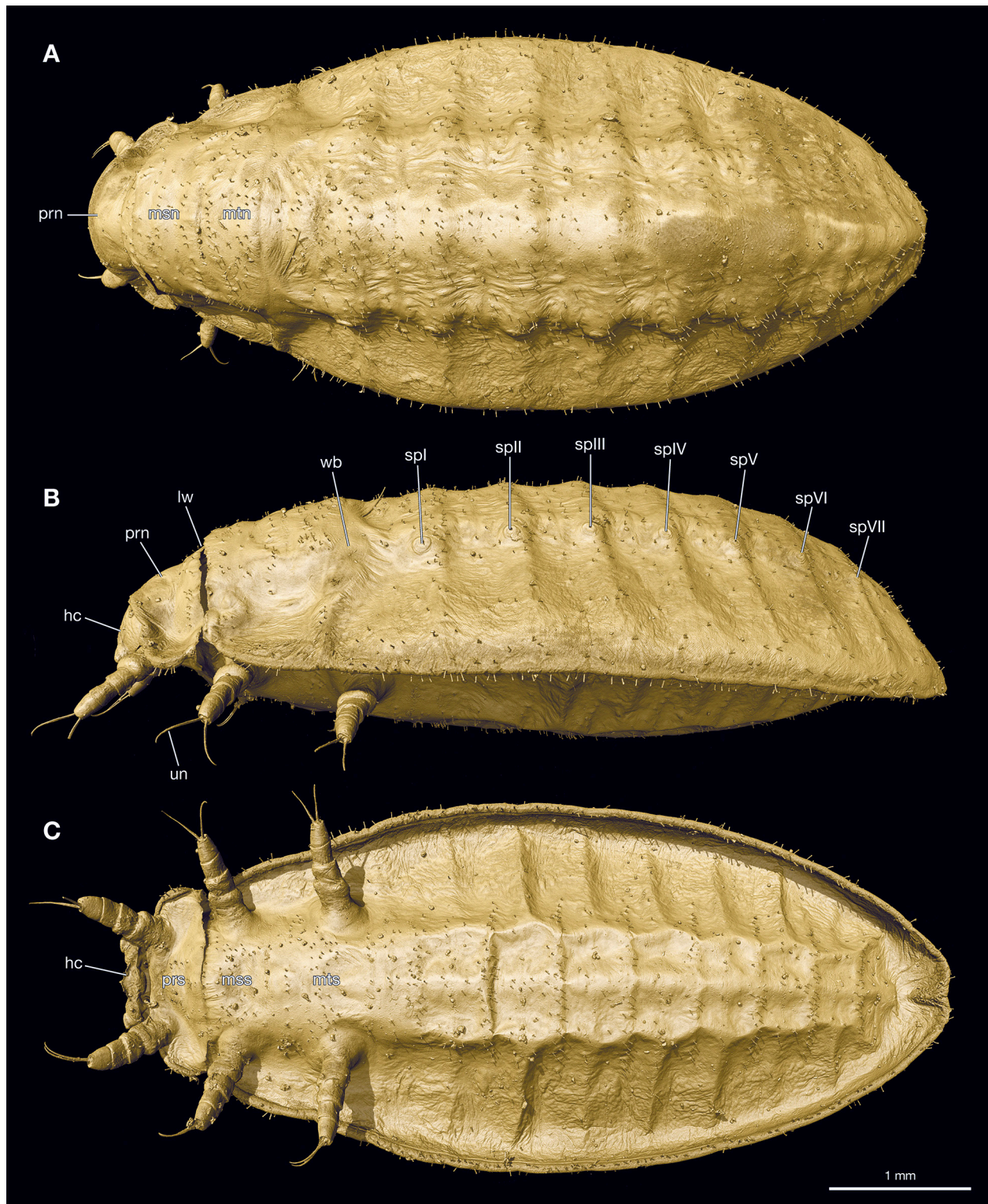

Fig. 9. Volume-rendered 3D micrographs of a male last instar larva (puparium) of *Eoxenos laboulbenei*; **A:** dorsal view; **B:** lateral view; **C:** ventral view. — **Abbreviations:** hc – head capsule; lw – line of weakness; msn – mesonotum; mss – mesosternum; mtn – metanotum; mts – metasternum; prn – pronotum; prs – prosternum; spl–VII – spiracles I–VII; un – pretarsal claw; wb – wing bud.

of the parsimony analyses clearly indicate that the fossil belongs to the stem group of Strepsiptera, as sister taxon of the crown group of the order. Apomorphies of Strepsiptera s.str., i.e. Mengenillidae + Stylopodia are the loss of the clypeolabral suture, linked with a size reduction of the labrum, the very distinct size reduction or loss of the

maxillary palp, and the presence of ventrally bent tergal extensions, with secondary loss in Stylopodia. An additional potential apomorphy is the filiform shape of the claws, which are entirely missing in Stylopodia.

Features shared by the fossil larvae and late instars of Mengenillidae include the broad body shape, the pres-

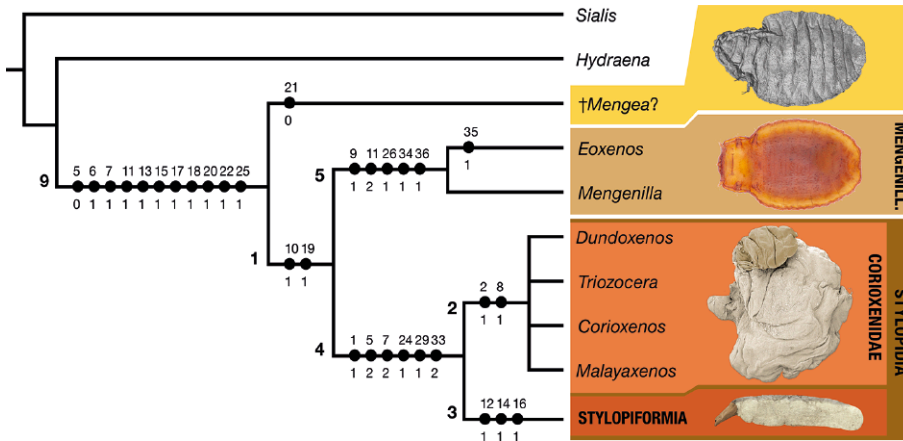

Fig. 10. Minimum length tree based on analysis of characters of female larvae; apomorphies mapped on the tree; branchings of Stylopiformia not shown (43 steps, CI = 0.97, RI = 0.98). Numbers above the circles refer to character numbers, and numbers below to character states. Bremer indices are given as bold numbers beneath branches. — *Abbreviation:* MENGANILL. – Mengenillidae.

ence of dorsal tubercles on the tergites, and one-segmented maxillary palpi. These character states likely belong to the groundplan of Strepsiptera, with secondary modification or loss in the endoparasitic final instars of Stylopodia. The monophyly of Mengenillidae was questioned based on the presence of a sensillum on the maxillary palp of *Eoxenos* and stem group strepsipterans. The characters analysed here support the family as a clade, with a serrated clypeal edge, an inflected labrum, and the presence of cuticular thorns on the postcephalic body surface of the puparia (Fig. 8) as potential autapomorphies. The presence of flat and delimited sternal “platforms” is likely an autapomorphy of the genus *Eoxenos* (Fig. 8C).

Among numerous derived features of both sexes and immature stages of Strepsiptera, autapomorphies of last instar larvae are the loss of dorsal Y-shaped and longitudinal ecdysial lines, very short one-segmented antennal buds, obliquely inserted mandibles, the fusion of the maxillary palpomeres, the loss of maxillary endite lobes, the absence of the labium, the trochanterofemur, and elongated slender claws. Additional derived features likely belonging to the groundplan of Strepsiptera are fields of tubercles on the tergites and a broad postcephalic body with laterally extended tergites. The data sets analysed here clearly confirm the monophyly of Stylopodia and Styloipiformia. The partial fusion of the head with the prothorax, the loss of the maxillary palp, and the partial reduction of the legs are autapomorphies of the former, and the complete fusion of the head with the postcephalic body, the loss of the convex antennal buds and the labrum, the minute mandibles, and the complete loss of the maxillae and legs are derived features of the latter.

The precise systematic placement of the larva cannot be assessed with certainty. However, embedding in Middle Eocene Baltic amber suggests affinities with other species of the strepsipteran stem group found in these deposits. If one assumes that the fossil last instar larvae of representatives of stem group strepsipterans were also slightly larger than adult extant strepsipterans (personal observations of H. Pohl 2018), then †*Protoxenos* with a body size of the male holotype of more than 7 mm (POHL et al. 2005) can be ruled out with reasonable certainty.

This leaves the two described †*Mengea* species, measuring between 1.5–3.1 mm as adult males (ULRICH 1927b; KULICKA 1978, 1979; POHL et al. 2010) as very likely candidates. Even though an assignment of the larva to this genus cannot be verified (or falsified) on principle (without DNA sequence data), it can be considered as a solid working hypothesis. Analyses with features of the last instar larva as male late instar of †*Mengea* place the genus as sister taxon of crown group Strepsiptera as already suggested in previous studies (POHL & BEUTEL 2005, 2016; BRAVO et al. 2009).

Last instar larvae of Mengenillidae can be found under stones or under bark near the ground in habitats with their hosts, silverfish (*Zygentoma*) of the genera *Ctenolepisma*, *Neoasterolepisma*, and *Tricholepisma* (Lepismatidae) (e.g., PARKER & SMITH 1933; personal observations of H. Pohl). When emerging from their host, the legs are directed backwards and placed close to the ventral side of the body (SILVESTRI 1941a, 1943; personal observations of H. Pohl 2018). Only afterwards, the legs are spread and the larvae move over a very short distance of few centimeters, if at all. Within approximately 15 minutes, the cuticle sclerotizes and forms the puparium in which the pupation takes place. The legs of the fossil last instar larva, which lie close to the body and point backwards, suggest that this larva reached the liquid resin immediately after penetrating the host’s body wall and emerging. In this process scales of the host silverfish always adhere to the cuticle of extant last instar larvae (personal observations of H. Pohl 2018). In this context it is noteworthy that scales were neither found on the cuticle of the fossil larvae nor in the surrounding amber. It is conceivable that the hosts were silverfish lacking scales, like for instance the “ancestral” *Lepidotrix piliferum* Menge, 1854 (Lepidotrichidae), which is described from Baltic amber. Alternative candidates are pterygote ground-living insects, such as for instance cockroaches. Finding pieces of Baltic amber with other specimens of this fossil larva and remnants of their hosts would shed light on this issue.

5. Conclusions

The first described fossil late instar larva of a strepsipteran belongs to the stem group of the order. An assignment to the extinct genus †*Mengea* is tentatively suggested. The complete absence of scales on the surface of the larva suggests that silverfish without scales were hosts. However, it cannot be excluded that the species parasitized pterygote insects.

6. Acknowledgements

We are very grateful to Prof. Dr. Dr. Martin Fischer and the Förderverein Phyletisches Museum e.V. for making it possible to purchase the fossil. We are also very grateful to Dr. Alexander Stoessel (Institut für Zoologie und Evolutionsforschung, FSU Jena) for the possibility to use the μ -CT for scans of extant immatures of *Eoxenos laboulbenei*.

7. References

- ANTELL G.S., KATHIRITHAMBY J. 2016. The first twisted-wing parasitoids (Insecta: Strepsiptera) from the Early Eocene Green River Formation of Colorado. – *Bulletin of the Peabody Museum of Natural History* **57**: 165–174.
- BEUTEL R.G., POHL H. 2006a. Endopterygote systematics – where do we stand and what is the goal (Hexapoda, Arthropoda)? – *Systematic Entomology* **31**: 202–219.
- BEUTEL R.G., POHL H. 2006b. Head structures of males of Strepsiptera (Hexapoda) with emphasis on basal splitting events within the order. – *Journal of Morphology* **267**: 536–554.
- BEUTEL R.G., FRIEDRICH F., HÖRNSCHEMEYER T., POHL H., HÜNEFELD F., BECKMANN F., MEIER R., MISOF B., WHITING M.F., VILHELMSSEN L. 2011. Morphological and molecular evidence converge upon a robust phylogeny of the megadiverse Holometabola. – *Cladistics* **27**: 341–355.
- BEUTEL R.G., POHL H., HÜNEFELD F. 2005. Strepsipteran b rains and effects of miniaturization (Insecta). – *Arthropod Structure and Development* **34**: 301–313.
- BOUSSAU B., WALTON Z., DELGADO J.A., COLLANTES F., BEANI L., STEWART I.J., CAMERON S.A., WHITFIELD J.B., JOHNSTON J.S., HOLLAND P.W.H., BACHTROG D., KATHIRITHAMBY J., HUELSENBECK J.P. 2014. Strepsiptera, phylogenomics and the long branch attraction problem. – *PLoS ONE* **9**: e107709.
- BRAVO F., POHL H., SILVA-NETO A., BEUTEL R.G. 2009. Bahiixenidae, a “living fossil” and a new family of Strepsiptera (Hexapoda) discovered in Brazil. – *Cladistics* **25**: 614–623.
- BREMER K. 1994. Branch support and tree stability. – *Cladistics* **10**: 295–304.
- ENGEL M.S., HUANG D., BREITKREUZ L.C.V., AZAR D., CAI C., ALVARADO M. 2016. A new twisted-wing parasitoid from mid-Cretaceous amber of Myanmar (Strepsiptera). – *Cretaceous Research* **58**: 777.e9–777.e15.
- FRAULOB M., POHL H. 2015. First record of *Eoxenos laboulbenei* de Peyerimhoff, 1919 (Strepsiptera, Mengenillidae) from Tuscany, central Italy. – *Linzer Biologische Beiträge* **47**(1): 591–595.
- FRAULOB M., BEUTEL R.G., MACHIDA R., POHL H. 2015. The embryonic development of *Stylops ovinae* (Strepsiptera, Stylopidae) with emphasis on external morphology. – *Arthropod Structure and Development* **44**: 42–68.
- GOLOBOFF P.A. 1995. NONA, Version 1.5. – Tucuman: Fundación e Instituto Miguel Lillo.
- GOLOBOFF P.A., FARRIS J.S., NIXON K.C. 2008. TNT, a free program for phylogenetic analysis. – *Cladistics* **24**: 774–786.
- GREVING I., WILDE F., OGURRECK M., HERZEN J., HAMMEL J.U., HIPPE A., FRIEDRICH F., LOTTERMOSER L., DOSE T., BURMESTER H., MÜLLER M., BECKMANN F. 2014. P05 imaging beamline at PETRA III: first results. – *Proceedings of SPIE – Developments in X-Ray Tomography IX* **9212**: 921200–921228.
- GRIMALDI D., KATHIRITHAMBY J., SCHAWAROCH V. 2005. Strepsiptera and triungula in Cretaceous amber. – *Insect Systematics & Evolution* **36**: 1–20.
- HAIBEL A., BECKMANN F., DOSE T., HERZEN J., OGURRECK M., MÜLLER M., SCHREYER A. 2010. Latest developments in microtomography and nanotomography at PETRA III. – *Powder Diffraction* **25**: 161–164.
- HAUPT H. 1950. Die Käfer (Coleoptera) aus der eozänen Braunkohle des Geiseltals. – *Geologica – Schriftenreihe der Geologischen Institute der Universitäten Berlin, Greifswald, Halle, Rostock* **6**: VII, 168 pp.
- HENDERICKX H., BOSSELAERS J., PAUWELS E., VAN HOOREBEKE L., BOONE M. 2013. X-ray micro-CT reconstruction reveals eight antennomeres in a new fossil taxon that constitutes a sister clade to *Dundoxenos* and *Triozocera* (Strepsiptera: Corioxenidae). – *Palaeontologia Electronica* **16**: 1–16.
- HÜNEFELD F., POHL H., WIPFLER B., BECKMANN F., BEUTEL R.G. 2011. The male postabdomen and genital apparatus of †*Mengea tertiaria*, a strepsipteran amber fossil (Insecta). – *Journal of Zoological Systematics and Evolutionary Research* **49**: 298–308.
- KATHIRITHAMBY J. 1991. Strepsiptera. Pp. 684–695 in: NAUMANN I.D., CARNE P.B., LAWRENCE J.F., NIELSEN E.S., SPRADBERRY J.P., TAYLOR R.W. et al. (eds), *The Insects of Australia: A Textbook for Students and Research Workers*. – Melbourne University Press, Melbourne.
- KATHIRITHAMBY J., HENDERICKX H. 2008. First record of the Strepsiptera genus *Caenocholax* in Baltic amber with the description of a new species. – *Phegea* **36**: 149–156.
- KINZELBACH R.K. 1971a. Strepsiptera (Fächerflügler). Pp. 1–73 in: HELMCKE J.-G., STARCK D., WERMUTH H. (eds), *Handbuch der Zoologie*, 4. – Walter de Gruyter, Berlin, New York.
- KINZELBACH R.K. 1971b. Morphologische Befunde an Fächerflüglern und ihre phylogenetische Bedeutung (Insecta: Strepsiptera). – *Zoologica* **41**. E. Schweizerbart’sche Verlagsbuchhandlung (Nägele u. Obermiller), Stuttgart.
- KINZELBACH R., LUTZ H. 1985. Stylopid larva from the Eocene – a spotlight on the phylogeny of the stylopids (Strepsiptera). – *Annals of the Entomological Society of America* **78**: 600–602.
- KINZELBACH R., POHL H. 1994. The fossil Strepsiptera (Insecta: Strepsiptera). – *Annals of the Entomological Society of America* **87**: 59–70.
- KNAUTHE P., BEUTEL R.G., HÖRNSCHEMEYER T., POHL H. 2016. Serial block-face scanning electron microscopy sheds new light on the head anatomy of an extremely miniaturized insect larva (Strepsiptera). – *Arthropod Systematics & Phylogeny* **74**: 107–126.
- KRISTENSEN N. 1999. Phylogeny of endopterygote insects, the most successful lineage of living organisms. – *European Journal of Entomology* **96**: 237–253.
- KULICKA R. 1978. *Mengea tertiaria* (Menge), (Strepsiptera) from the Baltic amber. – *Prace Muzeum Ziemi* **29**: 141–145.
- KULICKA R. 1979. *Mengea mengei* sp. n. from the Baltic amber. – *Prace Muzeum Ziemi* **32**: 109–112.
- LÖWE S., BEUTEL R.G., POHL H. 2016. The female cephalothorax of *Stylops ovinae* Noskiewicz & Poluszyński 1928 (Strepsiptera: Stylopidae). – *Arthropod Systematics & Phylogeny* **74**: 65–81.
- MADDISON W.P., MADDISON D.R. 2018. Mesquite: a modular system for evolutionary analysis. Version 3.51. <http://www.mesquite-project.org>.
- MISOF B., LIU SH., MEUSEMANN K., PETERS R.S., DONATH A., MAYER C., FRANSEN P.B., WARE J., FLOURI T., BEUTEL R.G., NIEHUIS O., PETERSEN M., IZQUIERDO-CARRASCO F., WAPPLER T., RUST J., ABERER A.J., ASPÖCK U., ASPÖCK H., BARTEL D., BLANKE A., BERGER S., BÖHM A., BUCKLEY T., CALCOTT B., CHEN J., FRIEDRICH F., FUKUI M., FUJITA M., GREVE C., GROBE G., GU SH., HUANG Y., JERMIIN L.S., KAWAHARA A.Y., KROGMANN L., KUBIAK M., LANFEAR R., LETSCH H., LI Y., LI ZH., LI J., LU H., MACHIDA R., MASHIMO Y.,

- KAPLI P., MCKENNA D.D., MENG G., NAKAGAKI Y., NAVARRETE-HEREDIA J.L., OTT M., OU Y., PASS G., PODSIADLOWSKI L., POHL H., REUMONT B.M. v., SCHÜTTE K., SEKIYA K., SHIMIZU SH., SLIPINSKI A., STAMATAKIS A., SONG W., SU X., SZUCSICH N.U., TAN M., TAN X., TANG M., TANG J., TIMELTHALER G., TOMIZUKA SH., TRAUTWEIN M., TONG X., UCHFUNE T., WALZL M.G., WIEGMANN B.M., WILBRANDT J., WIPFLER B., WONG T.K.F., WU Q., WU G., XIE Y., YANG SH., YANG Q., YEATES D.K., YOSHIZAWA K., ZHANG Q., ZHANG R., ZHANG W., ZHANG Y., ZHAO J., ZHOU CH., ZHOU L., ZIESMANN T., ZOU SH., LI Y., XU X., ZHANG Y., YANG H., WANG J., WANG J., KJER K.M., ZHOU X. 2014. Phylogenomics resolves the timing and pattern of insect evolution. – *Science* **346**: 763–767.
- MOOSMANN J., ERSHOV A., WEINHARDT V., BAUMBACH T., PRASAD M.S., LABONNE C., XIAO X., KASHEF J., HOFFMANN R. 2014. Time-lapse X-ray phase-contrast microtomography for *in vivo* imaging and analysis of morphogenesis. – *Nature Protocols* **9**: 294–304.
- NIEHUIS O., HARTIG G., GRATH S., POHL H., LEHMANN J., TAHER H., DONATH A., KRAUSS V., EISENHARDT C., HERTEL J., PETERSEN M., MAYER C., MEUSEMANN K., PETERS R.S., STADLER P.F., BEUTEL R.G., BORNBERG-BAUER E., MCKENNA D.D., MISOF B. 2012. Genomic and morphological evidence converge to resolve the enigma of Strepsiptera. – *Current Biology* **22**: 1309–1313.
- NIXON K.C., CARPENTER J.M. 1993. On outgroups. – *Cladistics* **9**: 413–426.
- ODIN G.S., LUTERBACHER H.P. 1992. The age of the Paleogene stage boundaries. – *Neues Jahrbuch für Geologie und Paläontologie* **186**: 21–48.
- OSSWALD J., POHL H., BEUTEL R.G. 2010. Extremely miniaturised and highly complex: The thoracic morphology of the first instar larva of *Mengenilla chobauti* (Insecta, Strepsiptera). – *Arthropod Structure and Development* **39**: 287–304.
- PARKER H., SMITH H. 1933. Additional notes on the strepsipteron *Eoxenos laboulbenei* Peyerimhoff. – *Annals of the Entomological Society of America* **26**: 217–233.
- PARKER H.L., SMITH H.D. 1934. Further notes on *Eoxenos laboulbenei* Peyerimhoff with a description of the male. – *Annals of the Entomological Society of America* **27**: 468–479.
- PEINERT M., WIPFLER B., JETSCHKE G., KLEINTEICH T., GORB S.N., BEUTEL R.G., POHL H. 2016. Traumatic insemination and female counter-adaptation in Strepsiptera (Insecta). – *Scientific Reports* **6**: 25052.
- PETERS R.S., MEUSEMANN K., PETERSEN M., WILBRANDT J., ZIESMANN J., DONATH A., MAYER C., KJER K.M., ASPÖCK U., ASPÖCK H., ABERER A., STAMATAKIS A., FRIEDRICH F., HÜNEFELD F., NIEHUIS O., BEUTEL R.G., MISOF B. 2014. The evolutionary history of holometabolous insects inferred from transcriptome-based phylogeny and comprehensive morphological data. – *BMC Evolutionary Biology* **14**: 52.
- POHL H. 2000. Die Primärlarven der Fächerflügler – evolutive Trends (Insecta, Strepsiptera). – *Kaupia, Darmstädter Beiträge zur Naturgeschichte* **10**: 1–144.
- POHL H. 2009. The oldest fossil strepsipteran larva (Insecta: Strepsiptera) from the Geisel Valley, Germany (Eocene). – *Insect Systematics & Evolution* **40**: 333–347.
- POHL H., BEUTEL R.G. 2004. Fine structure of adhesive devices of Strepsiptera (Insecta). – *Arthropod Structure and Development* **33**: 31–43.
- POHL H., BEUTEL R.G. 2005. The phylogeny of Strepsiptera (Hexapoda). – *Cladistics* **21**: 328–374.
- POHL H., BEUTEL R.G. 2008. The evolution of Strepsiptera (Hexapoda). – *Zoology* **111**: 318–338.
- POHL H., BEUTEL R.G. 2013. The Strepsiptera-Odyssey: the history of the systematic placement of an enigmatic parasitic insect order. – *Entomologia* **1**: e4.
- POHL H., BEUTEL R.G. 2016. †*Kinzelbachilla ellenbergeri* – a new ancestral species, genus and family of Strepsiptera (Insecta). – *Systematic Entomology* **41**: 287–297.
- POHL H., KINZELBACH R. 1995. Neufunde von Fächerflüglern aus dem Baltischen und Dominikanischen Bernstein (Strepsiptera: Bohartillidae & Myrmecolacidae). – *Mitteilungen des Geologisch-Paläontologischen Instituts der Universität Hamburg* **78**: 197–209.
- POHL H., KINZELBACH R. 2001. First record of a female stylopid (Strepsiptera: ?Myrmecolacidae) parasite of a prionomyrmecine ant (Hymenoptera: Formicidae) in Baltic amber. – *Insect Systematics & Evolution* **32**: 143–146.
- POHL H., MELBER A. 1996. Verzeichnis der mitteleuropäischen Fächerflügler und die Beschreibung einer neuen Art der Gattung *Malayaxenos* Kifune 1981. – *Senckenbergiana Biologica* **75**: 171–180.
- POHL H., BATELKA J., PROKOP J., MÜLLER P., YAVORSKAYA M.I., BEUTEL R.G. 2018. A needle in a haystack: Mesozoic origin of parasitism in Strepsiptera revealed by first definite Cretaceous primary larva (Insecta). – *PeerJ* **6**: e5943. doi.org/10.7717/peerj.5943
- POHL H., BEUTEL R.G., KINZELBACH R. 2005. Protoxenidae fam. nov. (Insecta, Strepsiptera) from Baltic amber – a “missing link” in strepsipteran phylogeny. – *Zoologica Scripta* **34**: 57–69.
- POHL H., NIEHUIS O., GLOYNA K., MISOF B., BEUTEL R. 2012. A new species of *Mengenilla* (Insecta, Strepsiptera) from Tunisia. – *ZooKeys* **198**: 79–101.
- POHL H., WIPFLER B., GRIMALDI D., BECKMANN F., BEUTEL R.G. 2010. Reconstructing the anatomy of the 42-million-year-old fossil *Mengea tertiaria* (Insecta, Strepsiptera). – *Naturwissenschaften* **97**: 855–859.
- RICHTER A., WIPFLER B., BEUTEL R.G., POHL H. 2017. The female cephalothorax of *Xenos vesparum* Rossi, 1793 (Strepsiptera: Xenidae). – *Arthropod Systematics & Phylogeny* **75**: 327–347.
- RITZKOWSKI S. 1997. K-Ar Altersbestimmung der bernsteinführenden Sedimente des Samlandes (Paläogen, Bezirk Kaliningrad). – *Metalla* **66**: 19–23.
- SILVESTRI F. 1941a. Studi sugli “Strepsiptera” (Insecta). I. Ridescrizione e ciclo dell’*Eoxenos Laboulbenei* Peyerimhoff. – *Bollettino del Laboratorio di Zoologia Generale e Agraria della Facoltà Agraria in Portici* **31**: 311–341.
- SILVESTRI F. 1941b. Studi sugli “Strepsiptera” (Insecta). II. Descrizione, biologia e sviluppo postembrionale dell’*Halictophagus tettigometrae* Silv. – *Bollettino del Laboratorio di Zoologia Generale e Agraria della Facoltà Agraria in Portici* **32**: 11–48.
- SILVESTRI F. 1943. Studi sugli “Strepsiptera” (Insecta). III. Descrizione e biologia di 6 specie italiane di *Mengenilla*. – *Bollettino del Laboratorio di Zoologia Generale e Agraria della Facoltà Agraria in Portici* **32**: 197–282.
- ULRICH W. 1927a. Strepsiptera, Fächerflügler. Pp. 1–103 in: SCHULZE P. (ed.), *Biologie der Tiere Deutschlands*. – G. Borntraeger, Berlin.
- ULRICH W. 1927b. Über das bisher einzige Strepsipteron aus dem baltischen Bernstein und über eine Theorie der Mengeinenbiologie. – *Zeitschrift für Morphologie und Ökologie der Tiere* **8**: 45–62.
- WANG B., KATHIRITHAMBY J., ENGEL M.S. 2015. The first twisted-wing parasitoid in Eocene amber from north-eastern China (Strepsiptera: Myrmecolacidae). – *Journal of Natural History* **50**: 1–9.
- WHEELER W.C., WHITING M., WHEELER Q.D., CARPENTER J.M. 2001. The phylogeny of the extant hexapod orders. – *Cladistics* **17**: 113–169.
- WHITING M., CARPENTER J., WHEELER Q., WHEELER W. 1997. The Strepsiptera problem: phylogeny of the holometabolous insect orders inferred from 18S and 28S ribosomal DNA sequences and morphology. – *Systematic Biology* **46**: 1–68.
- WILDE F., OGURRECK M., GREVING I., HAMMEL J.U., BECKMANN F., HIPPEL A., LOTTERMOSER L., KHOKHRIAKOV I., LYTAEV P., DOSE T., BURMESTER H., MÜLLER M., SCHREYER A. 2016. Micro-CT at the imaging beamline P05 at PETRA III. – Presented at the AIP, p. 030035.

8. Appendix: Characters of male puparium / male late instar larvae

(Numbers in brackets refer to characters in POHL & BEUTEL 2005.)

- 1(119). Endoparasitism: (0) absent; (1) present.** The male late instar larvae of *Mengenilla* and *Eoxenos* leave the host completely and form the puparium (e.g. POHL & BEUTEL 2005). Embedding in amber indicates that this also applies to the fossil late instar larva.
- 2(120). Shape of anterior body: (0) straight; (1) bent backwards towards caudal end of body.** Straight in fossil late instar larva and most other groups of Strepsiptera. Bent backwards in Corioxenidae, at least shortly before the body wall of the host is penetrated (KINZELBACH 1971b; POHL & MELBER 1996; POHL & BEUTEL 2005: fig. 26A).
- 3. Fields of tubercles on tergites: (0) absent; (1) present.** Fields of tubercles are present in the fossil late instar larva and final instars of Mengenillidae.
- 4. Y-shaped cephalic ecdysial suture: (0) present; (1) absent.** Absent in fossil late instar larva like in all other groups of Strepsiptera with known terminal instars (POHL & BEUTEL 2005).
- 5. Postcephalic dorsomedian ecdysial line: (0) present; (1) absent.** Also absent in fossil larva like and in all other groups of Strepsiptera (POHL & BEUTEL 2005), even though a faint dorso-medial furrow may be present in free-living later instars.
- 6(123). Circumferential line of weakness (cuticle weakly sclerotized): (0) absent; (1) between pro- and mesothorax; (2) between head (cephalotheca) and body.** Not visible in fossil late instar larva. Present as narrow circumferential zone of weakly sclerotized cuticle between pro- and mesothorax in 3rd instars of Mengenillidae and between head (cephalotheca) and thorax in Stylopodia (POHL & BEUTEL 2005).
- 7(124). Head: (0) not equally rounded, appendages distinctly developed; (1) equally rounded, appendages not prominent.** Antennae, mandibles and maxillae distinctly prominent like in Mengenillidae and Corioxenidae (POHL & BEUTEL 2005).
- 8(125). Lateral eyes: (0) stemmata; (1) compound eyes; (2) absent.** Stemmata in the outgroup taxa but distinctly developed compound eyes in the fossil late instar larva like in 3rd instars of Mengenillidae and second instars of Stylopodia (POHL & BEUTEL 2005). The compound eyes of the prepupal stage distinguish Strepsiptera from all other groups of holometabolous insects (e.g. BEUTEL et al. 2011).
- 9. Labrum: (0) present as a separate structure articulating with clypeus; (1) fused with clypeus or absent.** Large and articulated with the clypeus in fossil late instar larva. Distinctly smaller in 3rd instars of Mengenillidae and 2nd instars of Corioxenidae (POHL & BEUTEL 2005: fig. 26C) and fused with the anterior clypeal edge. Absent as a separate cephalic structure in Stylopiformia (POHL & BEUTEL 2005).
- 10. Serration on anterior clypeal edge: (0) absent; (1) present.** Serrated edge present in *Eoxenos* and *Mengenilla* but absent in fossil late instar larva.
- 11. Orientation of labrum relative to clypeus, i.e. angle between clypeus and labrum: (0) approx 0°; (1) approx. 45°; (2) approx. 90°.** Approx. 45° in fossil late instar larva and secondary larvae of Corioxenidae. Approx. 90° in final instars of Mengenillidae. Not applicable to taxa with state (1) in character 9.
- 12. Antenna: (0) present as a prominent or at least convex structure; (1) present as completely flat antennal field or absent.** Present as an unsegmented rounded bud in fossil late instar larva and late instar larvae of Mengenillidae and Corioxenidae. Absent or completely flat in Stylopiformia.
- 13. Antennal segmentation: (0) composed of several segments; (1) unsegmented bud.** Generally unsegmented in larvae of Strepsiptera (KINZELBACH 1971a; POHL & BEUTEL 2005: fig. 26C,D).
- 14. Mandible: (0) well-developed; (1) vestigial or absent.** Well developed in fossil late instar larva and late instar larvae of Mengenillidae and Corioxenidae (POHL & BEUTEL 2005: fig. 26C). Vestigial in Stylopiformia (POHL & BEUTEL 2005: fig. 26D).
- 15. Mandibular articulation: (0) axis between primary and secondary mandibular joint vertical; (1) axis oblique.** Oblique in fossil late instar larva and late instar larvae of Mengenillidae and Corioxenidae. Scored as inapplicable for Stylopiformia. Vertical in outgroup taxa.
- 16. Maxillary body: (0) distinct; (1) vestigial or absent.** Distinct in fossil late instar larva and late instar larvae of Mengenillidae and Corioxenidae. Vestigial or completely absent in Stylopiformia.
- 17. Cardo and stipes: (0) present as distinct maxillary subunits; (1) not present as separate maxillary subunits.** Generally not present as maxillary subunits in larvae of Strepsiptera.
- 18. Galea and lacinia: (0) present; (1) absent.** Generally absent in larvae of Strepsiptera.
- 19. Size of maxillary palp: (0) normally sized, same diameter as maxillary body; (1) very small or absent.** Normally sized in fossil late instar larvae. Very small in Mengenillidae. Vestigial or completely missing in Stylopodia (POHL & BEUTEL 2005: fig. 26C,D).
- 20. Segmentation of maxillary palp: (0) with several palpomeres; (1) undivided.** Scored as inapplicable for Stylopodia (POHL & BEUTEL 2005: fig. 26).
- 21. Labium: (0) present; (1) absent.** Generally absent in strepsipteran immatures.
- 22. Length of ventral side of head: (0) > ½ of length of prosternum; (0) ≤ ½ of length of prosternum or less.** Head on ventral side approximately half as long as prosternum in fossil late instar larva. Less than half as long or less in 3rd instars of Mengenillidae.
- 23(127). Wing buds: (0) absent; (1) present.** Absent in fossil 3rd instar larva. Present in Mengenillidae (POHL & BEUTEL 2005).
- 24(121). Legs: (0) present; (1) absent.** Present in fossil late instar larva and late instar instars of Mengenillidae and Corioxenidae. Absent in Stylopiformia.
- 25. Leg segmentation: (0) distinctly developed with six segments; (1) five-segmented, with tibiotarsus; (2) five-segmented, with trochanterofemur; (3) one-segmented.** Five-segmented with trochanterofemur in fossil late instar larva and 3rd instars of Mengenillidae. Distinctly reduced in Corioxenidae. Absence in Stylopiformia scored as inapplicable.
- 26. Claws: (0) present; (1) absent.** Present in fossil late instar larva and Mengenillidae. Absent in Stylopodia.
- 27(128). Shape of claws: (0) normally developed, elongated but with robust base; (1) filiform.** Elongated but with robust basal part in fossil late instar larva. Filiform in *Mengenilla* and *Eoxenos* (PARKER & SMITH 1933 1934; SILVESTRI 1943; POHL & BEUTEL 2004; POHL et al. 2012).
- 28. Number of pairs of spiracles: (0) eight pairs on segments I–VIII; (1) seven pairs on abdominal segments I–VII; (2) single pair at posterior end of cephalothorax; (3) absent.** Several spiracles in fossil late instar larva and larvae of Mengenillidae. Single spiracle in Stylopodia. Eight pairs in larvae of *Hydraena*. Absent in *Sialis*.
- 29. Ventrally bent lateral tergal extensions: (0) absent; (1) present.** Tergites laterally explanate in fossil late instar larva. Tergal extensions bent ventrad in puparia of Mengenillidae, resulting in a characteristic tortoise-shaped body form (e.g., PARKER & SMITH 1933; POHL et al. 2012).
- 30. Delimited flat platform on middle region of abdominal sternites resulting in a tortoise-like pattern: (0) absent; (1) present.** The elevated platform-like middle regions of the abdominal sternites of *Eoxenos* result in a tortoise-like pattern on the ventral side (FRAULOB & POHL 2015). This feature is absent in the fossil late instar larva and in *Mengenilla* (POHL et al. 2012).

Electronic Supplement Files

at <http://www.senckenberg.de/arthropod-systematics>

File 1: pohl&al-strepsipterafossil larva-asp2019-electronicsupplement-1.nex — Data matrix with characters of female late instar larvae. — DOI: 10.26049/ASP77-1-2019-06/1

File 2: pohl&al-strepsipterafossil larva-asp2019-electronicsupplement-2.nex — Data matrix with characters of male late instar larvae. — DOI: 10.26049/ASP77-1-2019-06/2

File 3: pohl&al-strepsipterafossil larva-asp2019-electronicsupplement-3.nex — Data matrix with characters of males, females and immature stages (fossil larva coded as female). — DOI: 10.26049/ASP77-1-2019-06/3

File 4: pohl&al-strepsipterafossil larva-asp2019-electronicsupplement-4.pdf — **Fig. S1.** Strict consensus tree based on an analysis of characters of male larvae; apomorphies mapped on the tree (37 steps, CI = 0.97, RI = 0.98). Numbers above the circles refer to character numbers, and numbers below to character states. — **Fig. S2.** Strict consensus tree based on an analysis of characters of males, females and immature stages (fossil larva coded as female); apomorphies mapped on the tree (309 steps, CI = 0.8, RI = 0.9). Numbers above the circles refer to character numbers, and numbers below to character states. — DOI: 10.26049/ASP77-1-2019-06/4

Authors' Contributions

H.P. analysed the data, prepared 3D reconstructions and figures; R.G.B. performed the phylogenetic analysis; J.U.H and A.R. carried out the micro computed tomography; H.P. and R.G.B. wrote the paper; R.G.B., J.U.H, H.P. and A.R. discussed the results and approved the final draft.

ZOBODAT - www.zobodat.at

Zoologisch-Botanische Datenbank/Zoological-Botanical Database

Digitale Literatur/Digital Literature

Zeitschrift/Journal: [Arthropod Systematics and Phylogeny](#)

Jahr/Year: 2019

Band/Volume: [77](#)

Autor(en)/Author(s): Pohl Hans, Hammel Jörg U., Richter Adrian, Beutel Rolf Georg

Artikel/Article: [The first fossil free-living late instar larva of Strepsiptera \(Insecta\) 125-140](#)